



BASIC MANUAL

HF/VHF/UHF ALL MODE TRANSCEIVER

IC-7100



This device complies with Part 15 of the FCC Rules. Operation is subject to the following two conditions: (1) this device may not cause harmful interference, and (2) this device must accept any interference received, including interference that may cause undesired operation.

WARNING: MODIFICATION OF THIS DEVICE TO RECEIVE CELLULAR RADIOTELEPHONE SERVICE SIGNALS IS PROHIBITED UNDER FCC RULES AND FEDERAL LAW.

Icom Inc.

Thank you for choosing this Icom product.

The IC-7100 HF/VHF/UHF ALL MODE TRANSCEIVER is designed and built with Icom's superior technology and craftsmanship combining traditional analog technologies with the new digital technology, Digital Smart Technologies for Amateur Radio (D-STAR), for a balanced package. With proper care, this product should provide you with years of trouble-free operation.

We thank you for making the IC-7100 your radio of choice, and hope you agree with Icom's philosophy of "technology first." Many hours of research and development went into the design of your IC-7100.

IMPORTANT

READ ALL INSTRUCTIONS carefully and completely before using the transceiver.

SAVE THIS INSTRUCTION MANUAL— This instruction manual contains important operating instructions for the IC-7100.

For advanced operating instructions, see the Full Manual for details. The Full Manual is available at the following internet address:

<https://www.icomjapan.com/support/>

FEATURES

- *IF DSP features*
- *All mode capability covering 160–2 m and 70 cm (depending on version)*
- *Compact with separated front panel*
- *±0.5 ppm of high frequency stability*
- *Baudot RTTY demodulator*
- *Selectable SSB transmission passband width (For both higher and lower pass frequency)*
- *Standard voice synthesizer/voice recorder*
- *SD card slot ready for several memory storage*
- *Voice recorder to records your communication*
- *DV mode (Digital voice + Low-speed data communication) operation-ready*
 - *Text message and call sign exchange*
 - *Transmit position data*
- *DR (D-STAR Repeater) mode and repeater list allow you to easily operate using a D-STAR repeater*

Icom is not responsible for the destruction, damage to, or performance of any Icom or non-Icom equipment, if the malfunction is because of:

- Force majeure, including, but not limited to, fires, earthquakes, storms, floods, lightning, or other natural disasters, disturbances, riots, war, or radioactive contamination.
- The use of Icom transceivers with any equipment that is not manufactured or approved by Icom.

EXPLICIT DEFINITIONS

WORD	DEFINITION
⚠ DANGER!	Personal death, serious injury or an explosion may occur.
⚠ WARNING!	Personal injury, fire hazard or electric shock may occur.
CAUTION	Equipment damage may occur.
NOTE	Recommended for optimum use. No risk of personal injury, fire or electric shock.

FCC INFORMATION

This equipment has been tested and found to comply with the limits for a Class B digital device, pursuant to part 15 of the FCC Rules. These limits are designed to provide reasonable protection against harmful interference in a residential installation. This equipment generates, uses and can radiate radio frequency energy and, if not installed and used in accordance with the instructions, may cause harmful interference to radio communications. However, there is no guarantee that interference will not occur in a particular installation. If this equipment does cause harmful interference to radio or television reception, which can be determined by turning the equipment off and on, the user is encouraged to try to correct the interference by one or more of the following measures:

- Reorient or relocate the receiving antenna.
- Increase the separation between the equipment and receiver.
- Connect the equipment into an outlet on a circuit different from that to which the receiver is connected.
- Consult the dealer or an experienced radio/TV technician for help.

CAUTION: Changes or modifications to this device, not expressly approved by Icom Inc., could void your authority to operate this device under FCC regulations.

Spurious signals may be received near some frequencies. These are created in the internal circuit and does not indicate a transceiver malfunction.

Icom, Icom Inc. and the Icom logo are registered trademarks of Icom Incorporated (Japan) in Japan, the United States, the United Kingdom, Germany, France, Spain, Russia, Australia, New Zealand, and/or other countries.

Microsoft and Windows are registered trademarks of Microsoft Corporation in the United States and/or other countries. Adobe, Acrobat, and Reader are either registered trademarks or trademarks of Adobe Systems Incorporated in the United States and/or other countries.

AMBE+2 is a trademark and property of Digital Voice Systems Inc.

All other products or brands are registered trademarks or trademarks of their respective holders.

PRECAUTIONS

⚠ **DANGER HIGH VOLTAGE! NEVER** touch an antenna or internal antenna connector during transmission. This may result in an electrical shock or burn.

⚠ **DANGER! NEVER** operate the transceiver near unshielded electrical blasting caps or in an explosive atmosphere. This could cause an explosion and death.

⚠ **WARNING RF EXPOSURE!** This device emits Radio Frequency (RF) energy. Extreme caution should be observed when operating this device. If you have any questions regarding RF exposure and safety standards please refer to the Federal Communications Commission Office of Engineering and Technology's report on Evaluating Compliance with FCC Guidelines for Human Radio Frequency Electromagnetic Fields (OET Bulletin 65).

⚠ **WARNING! NEVER** operate the transceiver while driving a vehicle. Safe driving requires your full attention—anything less may result in an accident.

⚠ **WARNING! NEVER** operate the transceiver with an earphone, headphones or other audio accessories at high volume levels. If you experience a ringing in your ears, reduce the volume level or discontinue use.

⚠ **WARNING! NEVER** apply AC power to the [DC 13.8V] connector on the transceiver rear panel. This could cause a fire or damage the transceiver.

⚠ **WARNING! NEVER** apply more than 16 V DC to the [DC13.8V] connector on the transceiver rear panel. This could cause a fire or damage the transceiver.

⚠ **WARNING! NEVER** reverse the DC power cable polarity. This could cause a fire or damage the transceiver.

⚠ **WARNING! NEVER** remove the fuse holder on the DC power cable. Excessive current caused by a short could cause a fire or damage the transceiver.

⚠ **WARNING! NEVER** let metal, wire or other objects the inside of the transceiver, or make incorrect contact with connectors on the rear panel. This could cause an electric shock or damage the transceiver.

⚠ **WARNING! NEVER** operate or touch the transceiver with wet hands. This could cause an electric shock or damage the transceiver.

⚠ **WARNING!** Immediately turn the transceiver power OFF and remove the power cable if it emits an abnormal odor, sound or smoke. Contact your Icom dealer or distributor for advice.

⚠ **WARNING! NEVER** put the transceiver on an unstable place where the transceiver may suddenly move or fall. This could cause an injury or damage the transceiver.

⚠ **WARNING! NEVER** operate the transceiver during a lightning storm. It may result in an electric shock, cause a fire or damage the transceiver. Always disconnect the power source and antenna before a storm.

CAUTION: NEVER expose the transceiver to rain, snow or any liquids.

CAUTION: NEVER change the internal settings of the transceiver. This may reduce transceiver performance and/or damage to the transceiver. The transceiver warranty does not cover any problems caused by unauthorized internal adjustments.

CAUTION: NEVER install or place the transceiver in a place without adequate ventilation, or block any cooling vents on the top, rear, sides or bottom of the transceiver. Heat dissipation may be reduced and damage the transceiver.

CAUTION: NEVER use harsh solvents such as benzine or alcohol to clean the transceiver, as they will damage the transceiver's surfaces. If the transceiver becomes dusty or dirty, wipe it clean with a soft, dry cloth.

CAUTION: NEVER leave the transceiver in areas with temperatures below -10°C ($+14^{\circ}\text{F}$) or above $+60^{\circ}\text{C}$ ($+140^{\circ}\text{F}$) for mobile operation.

CAUTION: NEVER place the transceiver in excessively dusty environments. This could damage the transceiver.

BE CAREFUL! The Main unit will become hot when operating the transceiver continuously for long periods of time.

CAUTION: If you use a linear amplifier, set the transceiver's RF output power to less than the linear amplifier's maximum input level, otherwise a high input could damage the linear amplifier.

CAUTION: Use only Icom supplied or optional microphones. Other manufacturer's microphones may have different pin assignments, and could damage the connector and/or the transceiver.

NEVER leave the transceiver in an insecure place to avoid use by unauthorized persons.

During mobile operation, **NEVER** place the transceiver where air bag deployment may be obstructed.

During mobile operation, **DO NOT** place the transceiver where hot or cold air blows directly onto it.

During mobile operation, **DO NOT** operate the transceiver without running the vehicle's engine. When the transceiver's power is ON and your vehicle's engine is OFF, the vehicle's battery will soon become exhausted.

Make sure the transceiver power is OFF before starting the vehicle engine. This will avoid possible damage to the transceiver by ignition voltage spikes.

During maritime mobile operation, keep the transceiver and microphone as far away as possible from the magnetic navigation compass to prevent erroneous indications.

SUPPLIED ACCESSORIES

The following accessories are supplied with the transceiver.

① Hand microphone	1
② Control cable	1
③ Ferrite EMI filter	1
For European versions	2
④ 3.5 (d) mm plug	1
⑤ ACC cable	1
⑥ DC power cable (OPC-1457)	1
or (OPC-2095)	1
⑦ Spare fuse (5 A)	1
⑧ USB cable	1
⑨ Spare fuse (30 A)	2

* Different types of accessories may be supplied, or may not be supplied depending on the transceiver version.

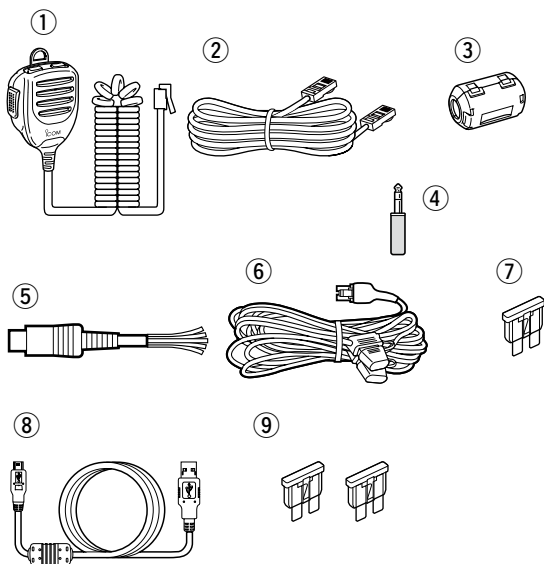

For European versions

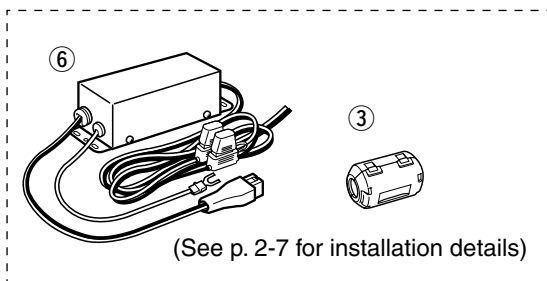

ABOUT THE MANUALS

You can use the following manuals to understand and operate this transceiver.

They are published at the following internet address:
<https://www.icomjapan.com/support/>

- **Basic Manual (This manual)**
 Instructions for the basic operations, the same as this manual
- **Full Manual (PDF type)**
 Instructions for the full operations, and more details are described than in this manual

The description '(FM sec. xx)' in this manual reminds you to refer to the section of Full Manual for detailed instructions.

For reference

- **HAM radio Terms**
 A glossary of HAM radio terms
 The glossary can be downloaded from the Icom website.

To read the manuals, Adobe® Acrobat® Reader® is required. If you have not installed it, please download the Adobe® Acrobat® Reader® and install it to your PC. You can download it from Adobe Systems Incorporated's website.

VOICE CORDING TECHNOLOGY

The AMBE+2™ voice coding Technology embodied in this product is protected by intellectual property rights including patent rights, copyrights and trade secrets of Digital Voice Systems, Inc. This voice coding Technology is licensed solely for use within this Communications Equipment.

The user of this Technology is explicitly prohibited from attempting to extract, remove, decompile, reverse engineer, or disassemble the Object Code, or in any other way convert the Object Code into a human-readable form.

U.S. Patent Nos.

#8,595,002, #8,359,197, #8,315,860, #8,200,497, #7,970,606, #6,912,495 B2.

Section 1

PANEL DESCRIPTION

Controller — Front panel	1-2
Controller — Function display	1-7
Controller — Multi-function keys	1-10
◇ M-1 (M-1 menu) Display	1-10
◇ M-2 (M-2 menu) Display	1-10
◇ M-3 (M-3 menu) Display	1-10
◇ D-1 (D-1 menu) Display	1-10
◇ D-2 (D-2 menu) Display	1-10
◇ Function keys on M-1 display	1-10
◇ Function keys on M-2 display	1-10
◇ Function keys on M-3 display	1-11
◇ Function keys on D-1 display	1-12
◇ Function keys on D-2 display	1-12
Controller — Rear and bottom panels	1-13
Main unit — Front panel	1-14
Main unit — Rear panel	1-14
◇ ACC socket information	1-16
◇ DATA2 socket information	1-17
◇ Microphone connector information	1-17
Microphone	1-18
◇ HM-198 (Supplied)	1-18
◇ SM-50 (Option)	1-18
◇ SM-30 (Option)	1-18
◇ HM-151 (Option)	1-19

Section 1 PANEL DESCRIPTION

Section 2 INSTALLATION AND CONNECTIONS

Section 3 BASIC OPERATION

Section 4 D-STAR INTRODUCTION

Section 5 D-STAR OPERATION <BASIC>

Section 6 SET MODE

Section 7 INFORMATION

'FM' means 'Full Manual.'
'sec. * *' means section number.

So when '(FM sec. * *)' is described on this manual, see the PDF type Full Manual's section number for your reference.

Controller — Front panel



1 POWER SWITCH•AF VOLUME [PWR]•[AF]

(p. 3-2)

- ➔ Push to turn ON the transceiver power.
 - First, confirm the DC power source is turned ON.
- ➔ Hold down for 1 second to turn OFF the power.
- ➔ Rotate to adjust the audio output level.

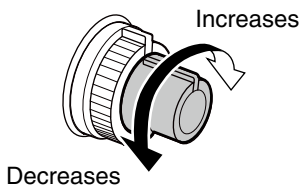

2 RF GAIN CONTROL/ SQUELCH CONTROL

[RF/SQL] (p. 3-19)

Rotate to adjust the RF gain and squelch threshold levels.

The squelch removes noise output to the speaker when no signal is received. (closed condition)

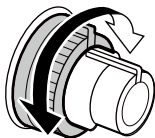

- The squelch is particularly effective for AM and FM, but also works in other modes.
- The 12 to 1 o'clock position is recommended for the most effective use of the [RF/SQL] control.
- [RF/SQL] operates as only an RF gain control in SSB, CW and RTTY (Squelch is fixed open), or a squelch control in AM, FM, WFM and DV (RF gain is fixed at maximum sensitivity), when "Auto" is selected as the "RF/SQL Control" item in the "Function" Set mode. (p. 6-5)

[SET] > Function > **RF/SQL Control**

• When used as an RF gain/squelch control

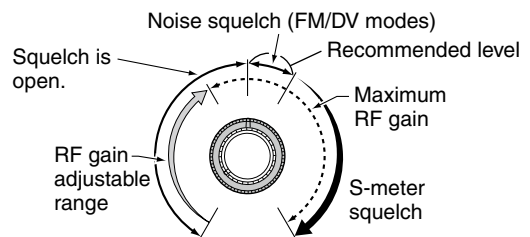

• When used as an RF gain control

(Squelch is fixed open; SSB, CW and RTTY only)

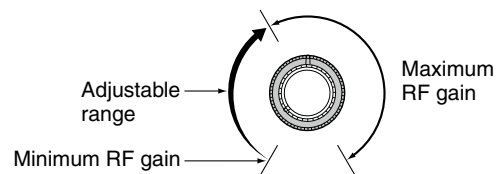

While rotating the RF gain control, a faint noise may be heard. This comes from the DSP unit and does not indicate an equipment malfunction.

• When used as a squelch control

(RF gain is fixed at maximum.)

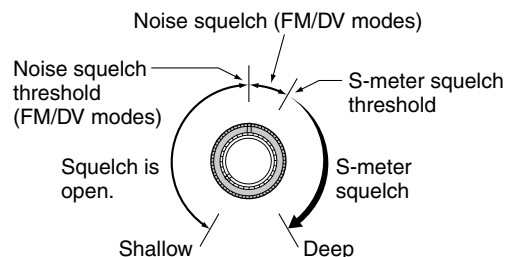

3 TX/RX LED

- ➔ Lights green when the squelch opens, or a signal is received.
- ➔ Lights red when transmitting.

4 MEMORY BANK CONTROL [BANK]⊙

- When both the PBT and RIT LEDs are OFF
Rotate to select a Memory bank.
- When the PBT LED (6) lights green
(Mode: SSB/CW/RTTY/AM)
Rotate to adjust the receiver's IF filter passband width using the DSP circuit.
- When the RIT LED (7) lights orange
Disable this control.

5 M-CH CONTROL•CLEAR SWITCH [M-CH]•[CLR]⊙

Push to select the action of the [M-CH/BANK]⊙ controls as the Memory/Bank selection, PBT control or RIT control.

- When the both RIT and PBT LEDs are OFF
Rotate to select a Memory channel.
- When the RIT LED lights orange
 - ➔ Rotate to adjust the RIT frequency shift.
 - The frequency shift range is ±9.99 kHz in 10 Hz steps. The control tunes in 1 Hz steps when the operating frequency readout is set to the 1 Hz step.
 - ➔ Hold down for 1 second to clear the RIT shift frequency.

✓ What is the RIT function?

The RIT (Receiver Incremental Tuning) shifts the receive frequency without shifting the transmit frequency. This is useful for fine tuning stations calling you off-frequency, or when you prefer to listen to slightly different-sounding voice characteristics.

- When the PBT LED lights green
(Mode: SSB/CW/RTTY/AM)
 - ➔ Rotate to adjust the receiver's IF filter passband width using the DSP circuit.
 - ➔ Hold down for 1 second to reset the PBT settings.
 - The PBT is adjustable in 50 Hz steps in the SSB/CW/RTTY modes, and 200 Hz in the AM mode. At that time, the shift value changes in 25 Hz steps in the SSB/CW/RTTY modes, and 100 Hz in the AM mode.
 - The PBT controls function as an IF shift control.

✓ What is the PBT control?

The PBT function electronically modifies the IF passband width to reject interference. This transceiver uses the DSP circuit for the PBT function.

6 PBT LED

- Lights green when the [M-CH/BANK]⊙ controls act as the PBT control.
 - Push the [M-CH]⊙ switch to select PBT control.

7 RIT LED

- ➔ Lights orange when the RIT function is turned ON.
- ➔ Lights orange when the [M-CH/BANK]⊙ controls act as the RIT control.
 - Push the [M-CH]⊙ switch to select RIT control.
 - The RIT control is the inner control. The outer control is disabled.

8 RIT KEY [RIT] (FM sec. 5)

- ➔ Push to turn the RIT function ON or OFF.
 - Use the [M-CH]⊙ control to vary the RIT frequency.
- ➔ Hold down for 1 second to add the shift frequency of the RIT function to, or subtract it from, the displayed frequency.

9 ANTENNA TUNER/CALL KEY [TUNER/CALL]

- ANTENNA TUNER KEY Operation (FM sec. 16)
(Frequency band: HF/50 MHz)
 - ➔ Push to turn an optional automatic antenna tuner ON or OFF (bypass).
 - ➔ Hold down for 1 second to manually tune the antenna tuner.
 - If the tuner cannot tune the antenna within 20 seconds, the tuning circuit is automatically bypassed.
- CALL KEY Operation (FM sec. 11)
(Frequency band: 144/430 MHz)
Push to select the Call channel.
In the 70 MHz band, push to sound an error beep.

10 MENU KEY [MENU] (p. 1-10)

- Push to change the set of functions assigned to the touch keys.
 - Toggles the function display menu between M-1, M-2 and M-3 menus or D-1 and D-2 menus.

11 MIC GAIN/RF POWER ADJUSTMENT KEY

[MIC/RF PWR] (p. 3-24)
Push to open the MIC gain/RF power adjustment display.

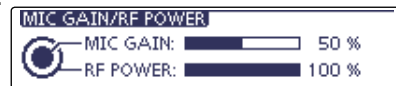

- Rotate [M-CH]⊙ to adjust the MIC gain.
- Rotate [BANK]⊙ to adjust the RF power.

Frequency band	RF output power range
HF/50 MHz	2 to 100 W (AM: 1 to 30 W)
70 MHz*	2 to 50 W (AM: 1 to 15 W)
144 MHz	2 to 50 W
430 MHz	2 to 35 W

- Push again to close the window.

* 70 MHz band transmission is available, depending on the transceiver version.

Controller — Front panel (Continued)



**12 NOISE BLANKER KEY [NB] (FM sec. 5)
(Mode: SSB/CW/RTTY/AM)**

- Push to turn the noise blanker ON or OFF. The noise blanker reduces pulse-type noise such as that generated by vehicle ignition systems. The noise blanker is not effective for non-pulse-type noise.
 - “NB” appears when the noise blanker is ON.
- Hold down for 1 second to display the “NB” screen. Push to return to the previous screen.

13 KEY SPEED/CW PITCH ADJUSTMENT KEY

[SPEED/PITCH] (FM sec. 4, 6)

Push to open the Key speed/CW pitch adjustment display.



- Rotate [M-CH] to adjust the keying speed of the internal electronic CW keyer to between 6 wpm (minimum) and 48 wpm (maximum).
- Rotate [BANK] to shift the received CW audio pitch and the CW sidetone pitch without changing the operating frequency.
- The CW pitch can be adjusted from 300 to 900 Hz in approximately 5 Hz steps.
- Push again to close the window.

14 NOISE REDUCTION KEY [NR] (FM sec. 5)

- Push to turn DSP noise reduction ON or OFF.
 - “NR” appears when noise reduction is ON.
- Hold down for 1 second to display the “NR” screen. Push to return to the previous screen.
 - Rotate the Dial to adjust the DSP noise reduction level. Set for maximum readability.

15 PREAMP•ATTENUATOR KEY [P.AMP/ATT]

- PREAMP KEY Operation (FM sec. 5)
(Frequency band: HF, 50/70 MHz)
Push to select one of two receive RF preamplifiers, or to bypass them.
 - “P. AMP1” is a wide dynamic range preamplifier. It is most effective for the 1.8 to 21 MHz bands.
 - “P. AMP2” is a high-gain preamplifier. It is most effective for the 24 to 70 MHz bands.
 - No indicator appears when the preamplifiers are not selected.

✓ What is the preamplifier?

The preamplifier amplifies signals in the front end to improve the S/N ratio and sensitivity. Select “P. AMP1” or “P. AMP2” when receiving weak signals.

(Frequency band: 144/430 MHz)

- Push to turn the preamplifier ON or OFF.
 - “P.AMP” appears when the preamplifier is ON.

- ATTENUATOR KEY Operation (FM sec. 5)
 - Hold down for 1 second to turn ON the attenuator.
 - “ATT” appears when the attenuator is ON.
 - Push to turn OFF the attenuator.
 - “ATT” disappears.

✓ What is the attenuator?

The attenuator prevents a desired signal from being distorted when very strong signals are near it, or when very strong electromagnetic fields, such as from a broadcasting station, are near your location.

16 NOTCH KEY [NOTCH] (FM sec. 5)

**(Mode = Auto notch: SSB/AM/FM
Manual notch: SSB/CW/RTTY/AM)**

- In the SSB and AM modes, push to toggle the notch function between auto, manual and OFF.
 - Either the Auto or Manual notch function can be turned OFF in the “[NOTCH] Switch (SSB)/(AM)” items of the “Function” Set mode. (6-21)

[SET] > Function > [NOTCH] Switch (SSB)

[SET] > Function > [NOTCH] Switch (AM)

- In the FM mode, push to turn the Auto Notch function ON or OFF.
- In the CW or RTTY mode, push to turn the Manual Notch function ON or OFF.
 - “MN” appears when the Manual Notch function is ON.
 - “AN” appears when the Auto Notch function is ON.
 - No indicator appears when the notch filter is OFF.
- Hold down for 1 second to display the “NOTCH” screen.
Push to return to the previous screen.
 - Rotate the Dial to adjust the notch frequency to reject an interfering signal when the manual function is ON.
 - Notch filter center frequency:

SSB/RTTY:	–1040 Hz to +4040 Hz
CW:	CW pitch frequency –2540 Hz to CW pitch frequency +2540 Hz
AM:	–5060 Hz to +5100 Hz

✓ What is the notch filter?

The notch filter is a narrow filter that eliminates unwanted CW or AM carrier tones, while preserving the desired voice signal. The DSP circuit automatically adjusts the notch frequency to effectively eliminate unwanted tones.

17 DR MODE KEY [DR] (Sections 4, 5, FM sec. 9)

- Push to select the DR mode.
 - When the DR mode is selected, the transceiver automatically selects the DV mode.
- In the DR mode, push to cancel it.
 - The transceiver returns to the previous screen before entering the DR mode.

18 SET MODE KEY [SET] (Section 6)

- Push to enter or exit the SET mode.
 - “Voice Memo,” “Call Sign,” “RX History,” “DV Memory,” “My Station,” “DV Set,” “GPS,” “SPEECH,” “QSO/RX Log,” “Function,” “Tone Control,” “Connectors,” “Display,” “Time Set,” “SD Card” and “Others” set group are selectable.

19 QUICK MENU KEY [QUICK]

- Push to open or close the Quick Menu window.
 - The Quick Menu is used to quickly select various functions.
- In the setting screen, push to open the Default set window.
 - Touch “Default” to reset to the default setting.

20 AUTO TUNE•RX→CS KEY [AUTO TUNE•RX→CS]

○ AUTO TUNE KEY Operation (FM sec. 4)

(Mode: CW)

- Push to automatically adjust for a zero beat with the received signal.
Zero beat means that two signals are exactly the same frequency.
 - “AUTO TUNE” blinks when the auto tune function is activated.
 - When the RIT function is ON, the auto tune function changes the RIT frequency, not the displayed frequency.

○ RX CALL SIGN CAPTURE KEY Operation

(p. 5-6)

(Mode: DV, when the DR mode is selected)

- Push to open the “RX>CS” screen.
Push again to return to the previous screen.
- Hold down for 1 second to set the received call signs (station and repeaters) as the operating call sign.

21 TRANSMIT FREQUENCY CHECK KEY [XFC]

- During split frequency or repeater operation, hold down to listen to the transmit frequency. (FM sec. 4)
 - While holding down this switch, the transmit frequency can be changed with the Dial or [MPAD].
 - When the Split Lock function is turned ON in the Split operation, hold down [XFC] to cancel the Dial lock function.
- When operating simplex, hold down to monitor the frequency.
 - While holding down this key, the squelch is open and the interference reject function is temporarily turned OFF.
- When operating simplex and the RIT function is turned ON, hold down to listen to the transmit frequency. The frequency is the same as when the RIT is OFF.
- In the DV mode, hold down this key to select the RX monitoring mode. (p. 6-3)

Controller — Front panel (Continued)



22 **SPEECH•LOCK KEY** [SPEECH] (SPEECH)

- **SPEECH KEY Operation** (p. 3-20)
Push to audibly announce the S-meter level, the displayed frequency and the operating mode.
 - The S-Level announcement can be turned OFF in the “S-Level SPEECH” item of the “SPEECH” Set mode. (p. 6-4)
[SET] > SPEECH > **S-Level SPEECH**
 - When RIT is ON, the RIT offset is not included in the frequency announcement.

- **LOCK KEY Operation** (FM sec. 5)
Hold down for 1 second to turn the Lock function ON or OFF.
 - The function electronically locks the Dial.
 - “[LOCK]” appears when the function is ON.
 - You can select the Dial lock and Panel lock in the “Lock Function” item of the “Function” Set mode. (p. 6-6)
[SET] > Function > **Lock Function**

NOTE: The [SPEECH/LOCK] key operation to activate the voice synthesizer or the Lock functions can be replaced in the “[SPEECH/LOCK] Switch” item of the “Function” Set mode. (p. 6-6)
[SET] > Function > **Lock Function**

23 **MEMO PAD KEY** [MPAD] (FM sec. 11)

- ➔ Push to sequentially call up the contents from the memo pad.
The 5 (or 10) most recently programmed frequencies and operating modes can be recalled, starting from the most recent.
 - The memo pad capacity can be increased from 5 to 10 in the “Memopad Numbers” item of the “Function” Set mode (p. 6-6)
[SET] > Function > **Memopad Numbers**
- ➔ Hold down for 1 second to write the displayed data into a memo pad.
 - The 5 most recent entries remain in the memo pad.

24 **MAIN DIAL**

Rotate to change the displayed frequency, select the Set mode settings, and so on.

25 **MAIN DIAL TENSION LATCH**

Select the Dial drag.
• Three positions are selectable. The top setting turns on clicks as the dial is turned.

Controller — Function display

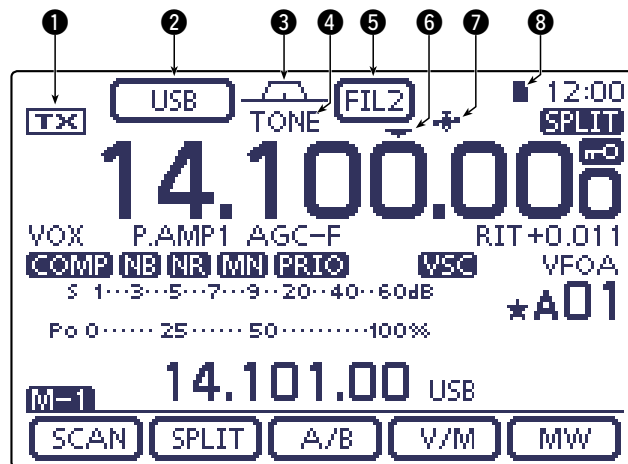

1 TX ICON

Indicates either the displayed frequency can be transmitted, or not.

- “TX” appears while the operating frequency is in an amateur band.
- “TX” appears while the operating frequency is not in an amateur band. However, when the “Band Edge Beep” item is set to “OFF” in the “Function” Set mode (p. 6-5), “TX” does not appear.

[SET] > Function > **Band Edge Beep**

- “LMT” appears while the output power is decreased because the Power FET’s temperature is high.
- “HOT” appears while transmission is inhibited because the Power FET’s temperature is too high.

2 MODE ICONS (p. 3-17)

- Displays the selected operating mode.
 - “-D” appears when SSB data, AM data or FM data mode is selected.
- Touch to enter the Mode selection screen.
 - On the Mode selection screen, touch the block to select the operating mode.

3 PASSBAND WIDTH ICON (FM sec. 5)

Graphically displays the passband width for twin PBT operation and the center frequency for IF shift operation.

4 TONE SQUELCH/DIGITAL SQUELCH ICONS

(Mode: FM)

- “TONE” appears when the repeater tone function is ON. (FM sec. 4)
- “TSQL” appears when the tone squelch function is ON. (FM sec. 4)
- “DTCS” appears when the DTCS function is ON. (FM sec. 4)

(Mode: DV)

- “DSQL” appears when the digital call sign squelch function is ON. (FM sec. 9)
- “CSQL” appears when digital code squelch function is ON. (FM sec. 9)

5 IF FILTER ICON (FM sec. 5)

- Shows the selected IF filter.
- Touch to select one of three IF filter settings.
 - The selected filter passband width and shifting value are displayed for 2 seconds in the window.
- Touch for 1 second to display the “FILTER” screen to adjust the filter passband width.
- When the “FILTER” screen is displayed, touch for 1 second to return to the previous screen.

6 QUICK TUNING ICON (p. 3-8)

Appears when the Quick tuning mode is selected.

- When “▼” is displayed, the frequency changes in preset kHz or 1 MHz quick tuning steps.
- When “▼” is not displayed, the frequency changes in 10 Hz or 1 Hz steps.

7 GPS ICON (FM sec. 10)

- Appears when valid position data is received from a GPS receiver that is connected to the [DATA1] jack.
- Blinks when invalid data is received from the GPS receiver.

8 SD CARD ICON

- “■” appears when an SD card is inserted.
- “■” and “□” alternately blinks while accessing the SD card.

Controller — Function display (Continued)

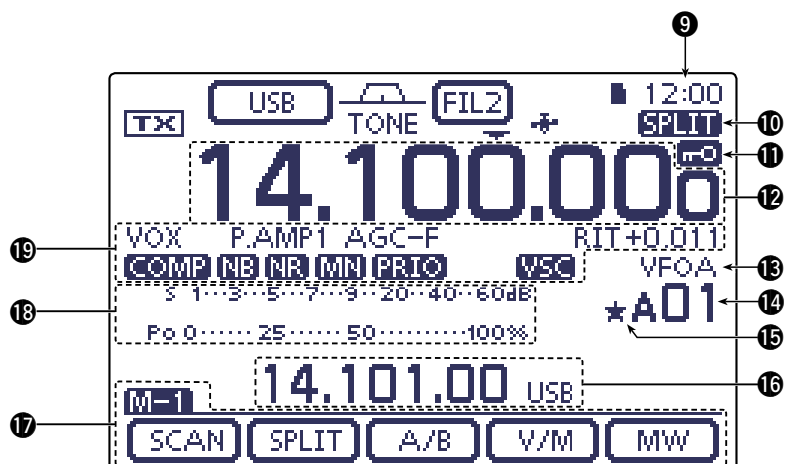

9 CLOCK READOUT

Shows the current time.
 • UTC time or local time can be selected.

10 SPLIT ICON (FM sec. 6)

“SPLIT” appears when the Split function is turned ON.

11 LOCK ICON (FM sec. 5)

“LCK” appears when the Lock function is activated.

**¼ TUNING DIAL SPEED ICON (p. 3-10)
 (Mode: SSB-D/CW/RTTY)**

“¼” appears when the tuning dial speed is set so that one rotation is equal to ¼ of the normal rotation.
 • This function is selectable only when the quick tuning function is turned OFF.

12 FREQUENCY READOUTS

- Displays the operating frequency.
- Touch the MHz digits to enter the Band selection screen.
- Touch the MHz digits for 1 second to turn the 1 MHz quick tuning mode ON or OFF.
- Touch the kHz digits to turn the preset kHz quick tuning mode ON or OFF.
- Touch the kHz digits for 1 second to enter the Tuning step selection screen.
- Touch the Hz digits to for 1 second to toggle between 10 Hz and 1 Hz steps.

13 VFO/MEMORY ICONS (p. 3-4)

- “VFOA” or “VFOB” appears whether VFO A or VFO B is selected.
- “MEMO” appears when the memory mode is selected.

14 MEMORY CHANNEL READOUT (FM sec. 11)

- Shows the selected memory channel, scan edge channel or Call channel.
 • Memory bank indicator (A to E) appears to the left of memory channel.
- Touch to toggle between the VFO and Memory modes.

15 SELECT MEMORY CHANNEL ICON

“★” appears when the selected memory channel is set as a select memory channel. (FM sec. 12)

16 INFORMATION READOUT

Displays the transmit frequency of the Split operation, descriptions of the memory channel or Received Call sign in the DV mode, and so on.

17 FUNCTION DISPLAY (p. 1-10)

- Shows the function of the Touch keys.
- Push **MENU** to change the set of functions assigned to the touch keys.
- Toggles the function display menu between M-1, M-2 and M-3 menus or D-1 and D-2 menus.

18 MULTI-FUNCTION METER INDICATION

- Displays the signal strength while receiving.
- Displays the relative output power, SWR, ALC or compression levels while transmitting.
- When the Meter Peak Hold function is ON, the peak level of a received signal strength or the output power is displayed for approximately 0.5 seconds.
- Touch to select the RF power, SWR, ALC or Compression meter.
- Touch for 1 second to display the Multi-function meter.

19 FUNCTION ICONS

- “VOX” appears when the VOX function is activated. (FM sec. 6)
- The Break-in icons appear when the Break-in function is turned ON. (FM sec. 6)
 - “F-BKIN” appears when the Full Break-in function is turned ON.
 - “BK-IN” appears when the Semi Break-in function is turned ON.
- The Preamp icons appear when a preamplifier is turned ON. (FM sec. 5)
 - In the HF, 50/70 MHz frequency band, either “P.AMP1” or “P.AMP2” is displayed when preamp 1 or preamp 2 is ON.
 - In the 144/430 MHz frequency band, “P.AMP” is displayed when the preamp is ON.
- “ATT” appears when the Attenuator function is turned ON. (FM sec. 5)
- The AGC icons display the selected AGC time constant. (FM sec. 5)
 - “AGC-F” for AGC fast; “AGC-M” for AGC mid; “AGC-S” for AGC slow; “AGC-OFF” for AGC OFF.
 - In the FM, WFM and DV mode, “AGC-F” for AGC fast is fixed.
- “DUP+” appears when plus duplex, “DUP –” appears when minus duplex (repeater) operation is selected. (FM sec. 4)
- “RIT” and the shift frequency are displayed when the RIT function is turned ON. (FM sec. 5)
- “COMP” appears when the Speech Compressor function is turned ON.
- “NB” appears when the Noise Blanker function is turned ON. (FM sec. 5)
- “NR” appears when the Noise Reduction function is turned ON. (FM sec. 5)
- The Notch icons appear when the Notch filter function is turned ON. (FM sec. 5)

(Mode: SSB/CW/RTTY/AM)

- “MN” appears when the Manual Notch function is turned ON.

(Mode: SSB/AM/FM)

- “AN” appears when the Automatic Notch function is turned ON.
- “PRIO” appears when priority scan is turned ON. (FM sec. 12)
- “VSC” appears when the VSC (Voice Squelch Control) function is turned ON.

(Mode: DV)

- “EMR” appears when the EMR (Enhanced Monitor Receive) communication mode is selected. (FM sec. 9)
 - In the EMR communication mode, no call sign setting is necessary when operating in the DV mode.
- “EMR” blinks when receiving an EMR signal.
- “BK” appears when the BK (Break-in) function is turned ON. (FM sec. 9)
 - The BK function allows you to break into a conversation where the two other stations are communicating with call sign squelch enabled.
- “BK” blinks when receiving a break-in call.

Controller — Multi-function keys

- ➔ Push **[MENU]** to change the set of functions assigned to touch keys.
 - Toggles the function display menu between M-1, M-2 and M-3 menus or D-1 and D-2 menus.
 - Functions vary, depending on the operating mode.
 - In the DR mode, the D-1 and D-2 menus can be selected.
- ➔ Touch or touch for 1 second to select the displayed functions.

◇ M-1 (M-1 menu) Display



◇ M-2 (M-2 menu) Display

(Mode: SSB)



(Mode: SSB-D)



(Mode: CW)



(Mode: RTTY)



(Mode: AM/AM-D)



(Mode: FM/FM-D/WFM)



(Mode: DV)



◇ M-3 (M-3 menu) Display

(Mode: SSB/AM/AM-D)



(Mode: SSB-D/RTTY)



(Mode: CW)



(Mode: FM/FM-D/WFM/DV)



◇ D-1 (D-1 menu) Display

(Mode: DV, when the DR mode is selected)



◇ D-2 (D-2 menu) Display

(Mode: DV, when the DR mode is selected)



◇ Function keys on M-1 display

SCAN KEY [SCAN] (FM sec. 12)

- ➔ Touch to display the “SCAN” screen.
- Push **[MENU]** to return to the previous screen.

SPLIT KEY [SPLIT] (FM sec. 6)

- ➔ Touch to turn the split function ON or OFF.
 - “**SPLIT**” appears when the split function is ON.
- ➔ Touch for 1 second to activate the quick split function.
 - The transmit frequency shifts from the receive frequency according to the “SPLIT Offset” option in the “Function” Set mode. (FM sec. 6)
 - [SET]** > Function > SPLIT/DUP > **SPLIT Offset**
 - The quick split function can be turned OFF in the “Quick SPLIT” item of the “Function” Set mode. (FM sec. 6)
 - [SET]** > Function > SPLIT/DUP > **Quick SPLIT**

VFO SELECT KEY [A/B] (p. 3-5)

- ➔ Touch to select either VFO A or VFO B.
- ➔ Touch for 1 second to equalize the undisplayed VFO settings to that of the displayed VFO.

VFO/MEMORY KEY [V/M]

- ➔ Touch to switch between the VFO and memory modes. (p. 3-4)
 - Touching Memory channel also selects the VFO or memory modes.
- ➔ Touch for 1 second to copy the memory contents to the displayed VFO. (FM sec. 11)

MEMORY WRITE KEY [MW] (FM sec. 11)

- ➔ Touch for 1 second to store VFO data into the selected memory channel.
 - This can be done in both the VFO and memory modes.

◇ Function keys on M-2 display

DUPLEX KEY [DUP] (FM sec. 4)

- ➔ Touch to select the duplex direction, or to turn OFF the function.
 - “DUP-” or “DUP+” is displayed during duplex operation.
- ➔ In the FM mode, touch for 1 second to turn the one-touch repeater function ON or OFF.

AGC KEY [AGC] (FM sec. 5)**(Mode: SSB/SSB-D/CW/RTTY/AM/AM-D)**

- AGC** ➔ Touch to select the time constant of the AGC circuit.
- ➔ Touch for 1 second to display the “AGC” screen.
- Push **MENU** to return to the previous screen.

STONE SQUELCH KEY [TONE] (FM sec. 4)**(Mode: FM)**

- TONE** ➔ Touch to select a tone function between subaudible (repeater) tone, tone squelch and DTCS.
- ➔ Touch for 1 second to display the “TONE” screen of the selected tone function.
- Push **MENU** to return to the previous screen.

DIGITAL SQUELCH KEY [DSQL] (FM sec. 9)**(Mode: DV)**

- DSQL** ➔ Touch to select a digital squelch function between digital call sign squelch and digital code squelch.
- ➔ Touch for 1 second to display the “DSQL” screen (digital squelch).
- Push **MENU** to return to the previous screen.

VOICE RECORDER KEY [VOICE] (FM sec. 15)**(Mode: SSB/AM/FM/DV)**

This function requires to insert an SD card.

- VOICE** Touch to display the “VOICE TX” screen or the “VOICE” (Root) screen, depending on the “VOICE 1st Menu” option in the “Function” Set mode (p. 6-6).
- SET** > Function > **VOICE 1st Menu**
- Push **MENU** to return to the previous screen.

MEMORY KEYS KEY [KEYER] (FM sec. 4)**(Mode: CW)**

- KEYER** Touch to display the “KEYER SEND” screen or the “KEYER” (Root) screen, depending on the “KEYER 1st Menu” option in the “Function” Set mode (p. 6-6).
- SET** > Function > **KEYER 1st Menu**
- Push **MENU** to return to the previous screen.

RTTY DECODER KEY [DEC] (FM sec. 4)

- DEC** Touch to display the RTTY Decoder screen.
- Push **MENU** to return to the previous screen.

SPEECH COMPRESSOR KEY [COMP] (FM sec. 6)**(Mode: SSB)**

- COMP** ➔ Touch to turn the speech compressor function ON or OFF.
- “**COMP**” is displayed when the speech compressor is ON.
- ➔ Touch for 1 second to display the “COMP” screen.
- Push **MENU** to return to the previous screen.

RTTY SET KEY [RTTY] (FM sec. 6)

- RTTY** Touch to display the “RTTY SET” screen.
- Push **MENU** to return to the previous screen.

CALL SIGN KEY [CS] (FM sec. 9)**(Mode: DV)**

- CS** Touch to display the “CALL SIGN” screen.
- The current call sign for DV operation appears.
 - Push **MENU** to return to the previous screen.

TRANSMISSION BANDWIDTH KEY [TBW] (FM sec. 6)**(Mode: SSB)**

- TBW** ➔ Touch to display the selected transmission bandwidth.
- ➔ Touch for 1 second to select the transmission bandwidth.
- Bandwidth is selectable from wide (WIDE), mid (MID) and narrow (NAR).

1/4 TUNING FUNCTION KEY [1/4] (p. 3-10)**(Mode: SSB-D/CW/RTTY)**

- 1/4** Touch to turn the 1/4 Tuning function ON or OFF.
- “**1/4**” is displayed when the 1/4 Tuning function is ON.

CALL RECORD KEY [CD] (FM sec. 9)**(Mode: DV)**

- CD** Touch to display the “RX HISTORY” screen.
- The call record channel appears. (RX01 to RX20)
 - Push **MENU** to return to the previous screen.

◆ **Function keys on M-3 display****MEMORY NAME KEY [MEMO]** (FM sec. 11)

- MEMO** Touch to display the “MEMO” (Memory menu) screen.
- Push **MENU** to return to the previous screen.

BAND SCOPE FUNCTION KEY [SCOPE] (FM sec. 5)

- SCOPE** Touch to display the “SCOPE” (Band scope) screen.

SWR GRAPH FUNCTION KEY [SWR] (FM sec. 6)

- SWR** Touch to display the “SWR” screen.
- Push **MENU** to return to the previous screen.

DTMF MODE KEY [DTMF] (FM sec. 6)**(Mode: FM/FM-D/DV)**

- DTMF** Touch to display the “DTMF” screen.
- Push **MENU** to return to the previous screen.

Controller — Multi-function keys

◇ Function keys on M-3 display (Continued)

VOX KEY [VOX] (FM sec. 6)
(Mode: SSB/AM/FM/DV)

- VOX** ➔ Touch to turn the VOX function ON or OFF.
- ➔ Touch for 1 second to display the “VOX” screen.
- Push **MENU** to return to the previous screen.

✓ **What is the VOX function?**

The VOX function (voice operated transmission) automatically starts transmission when you speak into the microphone, then automatically returns to receive when you stop speaking.

BK-IN KEY [BK-IN] (FM sec. 6)
(Mode: CW)

- BK-IN** ➔ Push to toggle the break-in operation between semi break-in and full break-in, or to turn OFF the break-in function.
- ➔ Hold down for 1 second to display the “BKIN” screen (Break-in). Push to return to the previous screen display.

✓ **What is the break-in function?**

The break-in function automatically switches between transmit and receive with your CW keying. Using Full break-in function (QSK), you can hear the receive frequency in-between keying.

◇ **Function keys on D-1 display**
(Mode: DV) (when the DR mode is selected)**SCAN KEY [SCAN]** (FM sec. 12)

- SCAN** ➔ Touch to start or cancel the Access repeater scan.
- ➔ Touch for 1 second to enter the “SCAN SET” mode screen.
- Push **MENU** to return to the previous screen.

SKIP KEY [SKIP]

- SKIP** ➔ Touch to set the Skip setting ON or OFF for the Access repeater scan.
- “**SKIP**” is displayed when the Skip setting is ON.
 - When a repeater is set as a skip target, the repeater cannot be selected in “FROM” (Access repeater).

VOICE RECORDER KEY [VOICE] (FM sec. 15)

This function requires to insert an SD card.

- VOICE** Touch to display the “VOICE TX” screen or the “VOICE” (Root) screen, depending on the “VOICE 1st Menu” option in the “Function” Set mode (p. 6-6).

SET > Function > **VOICE 1st Menu**

- Push **MENU** to return to the previous screen.

CALL SIGN KEY [CS] (FM sec. 9)

- CS** Touch to display the “CALL SIGN” screen.
- The current call sign for DV operation appears.
 - Push **MENU** to return to the previous screen.

CALL RECORD KEY [CD] (FM sec. 9)

- CD** Touch to display the “RX HISTORY” screen.
- The call record channel appears. (RX01 to RX20)
 - Push **MENU** to return to the previous screen.

◇ **Function keys on D-2 display**
(Mode: DV) (when the DR mode is selected)**MEMORY WRITE SWITCH [MW]** (FM sec. 11)

- MW** ➔ Touch to display the Memory channel screen.
- Touch [MW] for 1 second to store the DR mode data into the selected memory channel.
 - Push **MENU** to return to the previous screen.

DIGITAL SQUELCH KEY [DSQL] (FM sec. 9)

- DSQL** ➔ Touch to select a digital squelch function between digital call sign squelch and digital code squelch.
- ➔ Touch for 1 second to display the “DSQL” screen (digital squelch).
- Push **MENU** to return to the previous screen.

DTMF MODE KEY [DTMF] (FM sec. 6)

- DTMF** Touch to display the “DTMF” screen.
- Push **MENU** to return to the previous screen.

VOX KEY [VOX] (FM sec. 6)

- VOX** ➔ Touch to turn the VOX function ON or OFF.
- ➔ Touch for 1 second to display the “VOX” screen.
- Push **MENU** to return to the previous screen.

✓ **What is the VOX function?**

The VOX function (voice operated transmission) automatically starts transmission when you speak into the microphone; then automatically returns to receive when you stop speaking.

Controller — Rear and bottom panels

Rear panel

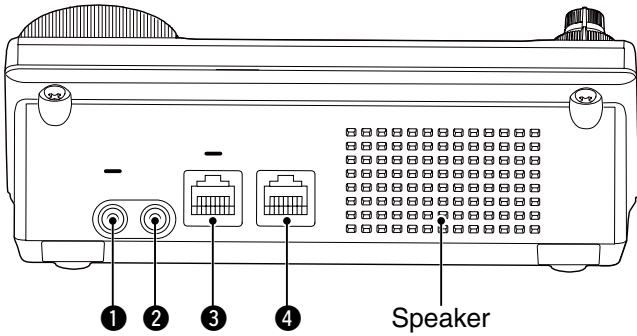

Bottom panel

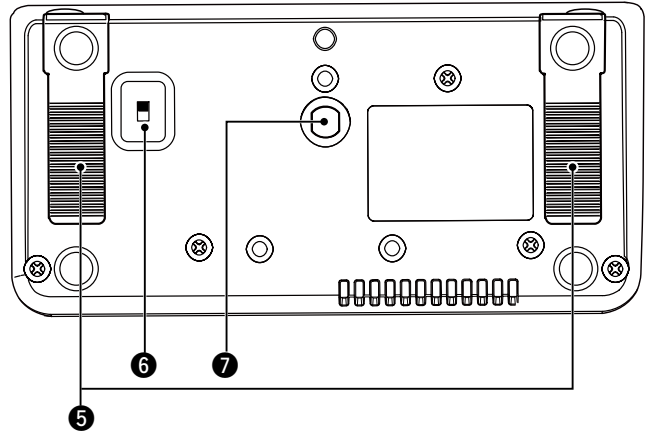

- 1 HEADPHONE/SPEAKER JACK [PHONES/SP]**
 Plug in standard stereo headphones (impedance: 8 to 16 Ω).
 • Output power: More than 5 mW with an 8 Ω load.
 • When headphones are connected, the internal speaker, and any external speaker, are disabled.
 • When the [PHONES/SP] switch (6) on the bottom panel is set to the SPEAKER position, an external speaker can be used instead of headphones. This is convenient for mobile or outdoor operation.

- 2 ELECTRONIC KEYSER JACK [ELEC-KEY]**
 Plug in a bug or paddle type key to use the internal electronic keyer for CW operation. (FM sec. 4)
 • Set the keyer type to ELEC-KEY, BUG-KEY or Straight key in the “Keyer Type” item of the “KEYER SET” mode.
 • When a straight key is connected, “Straight key” must be selected in the “Keyer Type” item of the “KEYER SET” mode. (FM sec. 4)
 • A straight key jack is located on the rear panel. See [KEY] on pages 1-15 and 2-5.
 • You can reverse the keyer paddle polarity (dot and dash) in the “Paddle Polarity” item of the “KEYER SET” mode. (FM sec. 4)
 • Four keyer memory channels are available for your convenience. (FM sec. 4)

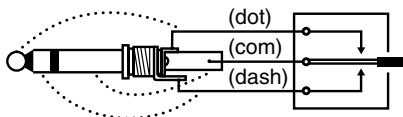

A standard 3.5(d) mm/ 1/8 inch plug

- 3 MICROPHONE CONNECTOR [MIC]**
 Plug in the supplied or an optional microphone.
 • See FM sec. 21 for appropriate microphones.
 • See p. 1-17 for microphone connector information.
 • The optional OPC-589 cable can be used to connect an 8-pin microphone such as the SM-30 or SM-50.
 • A microphone connector is also available on the Main unit.
 // DO NOT simultaneously connect two microphones.
- 4 MAIN UNIT CONNECTOR [MAIN UNIT]**
 Connects to the Main unit using with the supplied OPC-2253 Control cable.
 • The OPC-2253 Control cable is 3.5 meter (11.5 feet) long.
 // DO NOT use any third party's Ethernet cables.
- 5 STAND**
 The length of the stand can be adjusted in two steps.
 • Adjust to the length not to incline back when you operate the Front panel.
- 6 PHONES/SPEAKER SWITCH [PHONE/SP]**
 Selects the [PHONES/SP] jack to connect a Headphones or external speaker.
- 7 SCREW HOLE FOR STAND**
 Accepts the screw of a tripod stand. (Third party product.)

Main unit — Front panel

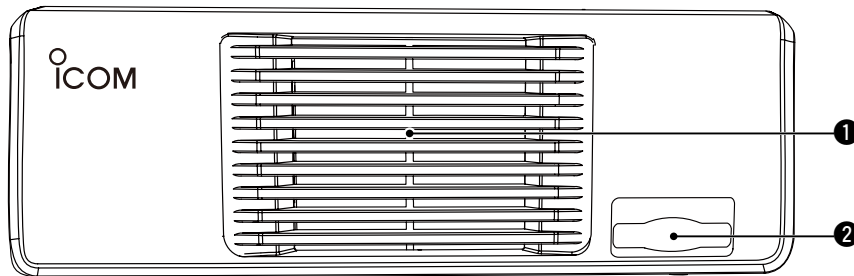

1 COOLING FAN

This is a cooling fan for heat dissipation. Depending on the internal temperature, it rotates at a Low, Mid or High speed.

2 SD CARD SLOT [SD CARD]

Insert an SD card of up to 32 GB SDHC. See FM sec. 13 for details.

Main unit — Rear panel

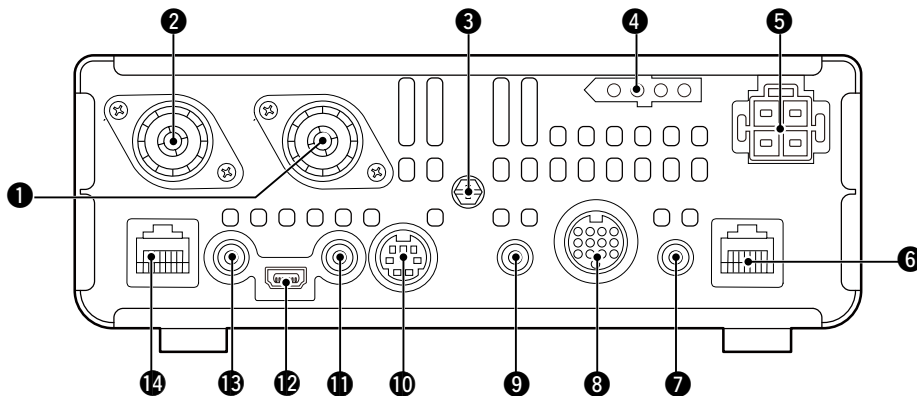

1 ANTENNA CONNECTOR 1 [ANT1]

2 ANTENNA CONNECTOR 2 [ANT2] (p. 2-2)

Connect a 50 Ω antenna with a PL-259 plug connector.

- [ANT1] is used for the HF, 50/70 MHz frequency bands.
- [ANT2] is used for the 144/430 MHz frequency bands.
- [ANT1] is used below 74.8 MHz, and [ANT2] is used for 74.8 MHz or above.

When using an optional AH-4, AH-740 or AT-180 Automatic antenna tuner, connect it to the [ANT1] connector.

3 GROUND TERMINAL [GND] (p. 2-2)

Connect this terminal to ground to prevent electrical shocks, TVI, BCI and other problems.

4 TUNER CONTROL SOCKET [TUNER] (p. 2-6)

Connect the control cable from an optional AH-4 or AH-740 Automatic antenna tuner.

5 DC POWER SOCKET [DC 13.8V] (p. 2-7)

Connect 13.8 V DC through the supplied DC power cable.

Rear panel view

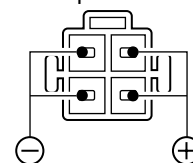

6 CONTROLLER CONNECTOR [CONTROLLER]

Connects to the Controller using with the supplied OPC-2253 Control cable.

- The OPC-2253 Control cable is 3.5 meter (11.5 feet) length.
- DO NOT use any third party's Ethernet cables.

7 STRAIGHT KEY JACK [KEY] (p. 2-5)

Connect a straight key or external electronic keyer using a standard 3.5(d) mm/ 1/8 inch plug.

- To use the internal electronic keyer for CW operation, connect to [ELEC-KEY] on the Front panel of the Controller. (p. 1-13)

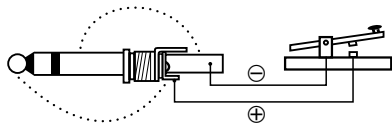
**8 ACCESSORY SOCKET [ACC]**

Connect control lines for external equipment such as a linear amplifier, an automatic antenna selector/tuner, a TNC for data communications, and so on.

- See page 1-16 for socket information.

9 DATA1 JACK [DATA1] (p. 2-6)

- ➔ Connect a PC through the optional OPC-1529R DATA COMMUNICATION CABLE, for low-speed data communication in the DV mode. (FM sec. 9)
- ➔ Connect a GPS receiver through the optional OPC-1529R DATA COMMUNICATION CABLE, for GPS operation. (FM sec. 10)

10 DATA2 SOCKET [DATA2] (p. 2-6)

Connect a TNC (Terminal Node Controller), and so on, for high speed data communications.

11 CI-V REMOTE CONTROL JACK [REMOTE]

(p. 2-6)

- ➔ Connect a PC, using the optional CT-17 CI-V LEVEL CONVERTER, for external control of the transceiver.
- ➔ Use for the transceive function with another Icom CI-V transceiver or receiver.

When the transceive function is set to ON, changing the frequency, operating mode and so on, on the IC-7100 automatically changes those settings on other Icom transceivers or receivers, and vice versa.

- ➔ Connect another IC-7100, using a mini plug cable*, for transceiver to transceiver cloning.
* Purchase separately

12 USB (Universal Serial Bus) PORT [USB]

Using a USB cable, connect a PC to do the following:

- Input modulation
- Remotely control the transceiver using CI-V commands (FM sec. 20)
- Send the received audio to the PC
- Send the decoded characters to the PC
- Low-speed data communication in the DV mode (FM sec. 9)
- Cloning using the optional CS-7100 CLONING SOFTWARE (FM sec. 21)

- Remote control operation using the optional RS-BA1 IP REMOTE CONTROL SOFTWARE (FM sec. 21)

- Two COM port numbers are assigned to the [USB] connector. One of them is "USB1," used for cloning and CI-V operation. The other one is "USB2," whose function is selected in "USB2 Function" item of the "Connectors" Set mode. (p. 6-8)

[SET] > Connectors > USB2/DATA1 Function >

USB2 Function

About the USB driver:

The USB driver and the installation guide can be downloaded from our website.

➔ <https://www.icomjapan.com/support/>

The following items are required:

PC

- Microsoft® Windows® 10 (32/64 bit) or Microsoft® Windows® 8.1 (32/64 bit)*
- *Except for Microsoft® Windows® RT.
- A USB 1.1, 2.0 or 3.0 port

Other items

- USB cable (supplied with the transceiver)
- PC software (such as the optional RS-BA1 or CS-7100)

⚡ **NEVER** connect the transceiver to a PC until the USB driver installation has been completed.

About the modulation input:

Select "USB" in the "Connectors" Set mode item "DATA OFF MOD" or "DATA MOD." The modulation input level from the USB jack can be set in the Set mode item "USB MOD Level." (FM sec. 6)

[SET] > Connectors > **DATA OFF MOD**

[SET] > Connectors > **DATA MOD**

[SET] > Connectors > **USB MOD Level**

⚡ While cloning using the CS-7100 software, **DO NOT** connect anything to the [REMOTE] jack.

13 EXTERNAL SPEAKER JACK [SP]

Connect to an external speaker (4 to 8 \emptyset).

14 MICROPHONE CONNECTOR [MIC]

Plug in the supplied or an optional microphone.

- See FM sec. 21 for appropriate microphones.
- See p. 1-17 for microphone connector information.
- The optional OPC-589 cable can be used to connect an 8-pin microphone such as the SM-30 or SM-50.
- A microphone connector is also available on the Controller.

⚡ **DO NOT** simultaneously connect two microphones.

1 PANEL DESCRIPTION

Main unit — Rear panel (Continued)

◇ ACC socket information

• ACC socket

ACC	PIN No.	NAME	DESCRIPTION	SPECIFICATIONS	
 <p>Rear panel view</p> <p>① brown ⑧ gray ② red ⑨ white ③ orange ⑩ black ④ yellow ⑪ pink ⑤ green ⑫ light blue ⑥ blue ⑬ light green ⑦ purple</p> <p>Color refers to the cable strands of the supplied cable.</p>	1	8 V	Regulated 8 V output.	Output voltage: 8 V ± 0.3 V Output current: Less than 10 mA	
	2	GND	Connects to ground.	—	
	3	HSEND ^{*1, 2}	Input/output pin.	An external equipment controls the transceiver. When this pin goes low, the transceiver transmits. The transceiver outputs a low signal to control external equipment.	Input voltage (High): 2.0 V to 20.0 V Input voltage (Low): -0.5 V to +0.8 V Current flow: Maximum 20 mA Output voltage (Low): Less than 0.1 V Current flow: Maximum 200 mA
	4	BDT	Data line for the optional AT-180.	—	
	5	NC (BAND ^{*3})	^{*3} If the modification is performed, band voltage output. (FM sec. 19)	—	Output voltage: 0 to 8 V
	6	ALC	ALC voltage input.	Control voltage: -4 V to 0 V Input impedance: More than 3.3 kΩ	
	7	VSEND ^{*1, 2}	Input/output pin.	An external equipment controls the transceiver. When this pin goes low, the transceiver transmits. The transceiver outputs a low signal to control external equipment.	Input voltage (High): 2.0 V to 20.0 V Input voltage (Low): -0.5 V to +0.8 V Current flow: Maximum 20 mA Output voltage (Low): Less than 0.1 V Current flow: Maximum 200 mA
	8	13.8 V	13.8 V output when power is ON.	Output current: Less than 1 A	
	9	TKEY	Key line for the optional AT-180.	—	
	10	FSKK	Controls RTTY keying	“High” level: More than 2.4 V “Low” level: Less than 0.6 V Output current: Less than 2 mA	
	11	MOD	Modulator input.	Input impedance: 10 kΩ Input level: Approx. 100 mV rms	
	12	AF ^{*3}	AF detector output. Fixed level, regardless of the [AF] control position.	Output impedance: 4.7 kΩ Output level: 100 to 300 mV rms	
	13	SQL S	Squelch output. Grounded when squelch opens.	SQL open: Less than 0.3 V/5 mA SQL closed: More than 6.0 V/100 μA	

^{*1} When the SEND terminal controls the inductive load (such as a relay), a counter-electromotive force can cause the transceiver's malfunction or damage. To prevent this, we recommend adding a switching diode, such as an “1SS133,” on the load side of the circuit to the counter-electromotive force absorption.

When the diode is added, a switching delay of the relay may occur. Be sure to check its switching action before operation.

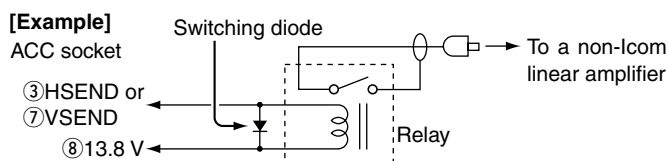

^{*2} VSEND is used for the 144 MHz and 430 MHz bands, and HSEND is used for the HF, 50/70 MHz bands by default. You can change this setting in “VSEND Select” of the “Connectors” Set mode. (p. 6-8)

[SET] > Connectors > **VSEND Select**

^{*3} You can change this setting in “ACC/USB Output Select” of the “Connectors” Set mode. (p. 6-8)

[SET] > Connectors > **ACC/USB Output Select**

• When connecting the ACC conversion cable (OPC-599)

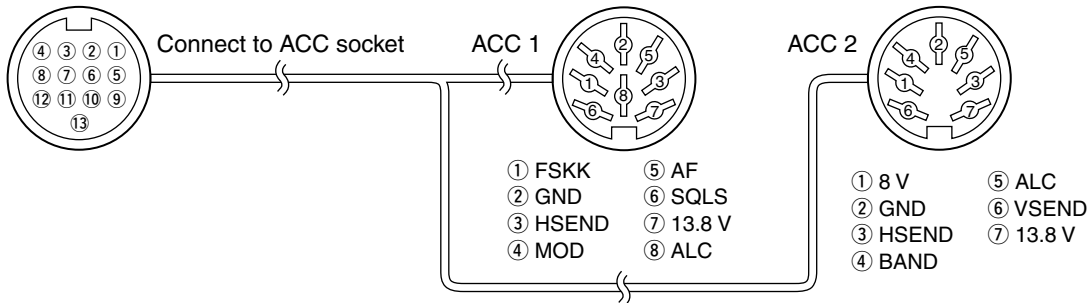

◇ DATA2 socket information

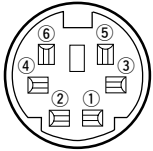
DATA2	PIN No.	NAME	DESCRIPTION	SPECIFICATIONS
 <p>Rear panel view</p>	1	DATA IN	Input terminal for data transmit. (1200 bps: AFSK/ 9600 bps: G3RUH, GMSK)	Input level (1200 bps): 100 mV Input level (9600 bps): 0.2 to 0.5 Vp-p
	2	GND	Common ground for DATA IN, DATA OUT and AF OUT.	—
	3	PTT	PTT terminal for packet operation. Connect to ground to activate the transmitter.	Input voltage (High): 2.0 V to 20.0 V Input voltage (Low): -0.5 V to +0.8 V
	4	DATA OUT	Data out terminal for 9600 bps operation only.	Output impedance: 10 kΩ Output level: 1.0 Vp-p
	5	AF OUT	Data out terminal for 1200 bps operation only.	Output impedance: 4.7 kΩ Output level: 100–300 mV rms
	6	SQL	Squelch out terminal. This pin is grounded when the transceiver receives a signal which opens the squelch. • To avoid interfering transmissions, connect squelch to the TNC to inhibit transmission when squelch is open. • Keep RF gain at a normal level, otherwise a “SQL” signal will not be output.	SQL open: Less than 0.3 V/ 5 mA SQL closed: More than 6.0 V/ 100 μA

◇ Microphone connector information

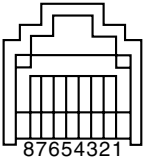
MIC	PIN No.	NAME	DESCRIPTION	SPECIFICATIONS
 <p>Rear panel view</p>	1	8 V	+8 V DC output.	Maximum 10 mA
	2	MIC U/D	Frequency Up/Down	UP: Ground DN: Ground through 470 Ω
	3	M8V SW	HM-151 connection Ground to indicate the HM-151 is connected. When the HM-151 is not connected; outputs an AF.*1	—
	4	PTT	PTT input	—
	5	MIC E	Microphone ground	—
	6	MIC	Microphone input	—
	7	GND	Ground	—
	8	DATA IN	When the HM-151 is connected; HM-151 data input	—
	SQL SW	When the HM-151 is not connected; Squelch switch	Open: ‘Low’ level Close: ‘High’ level	

*1 You can change this setting in “MIC AF Out” of the “Function” Set mode. (p. 6-6)

[SET] > Function > MIC AF Out

Microphone

◇ HM-198 (Supplied)

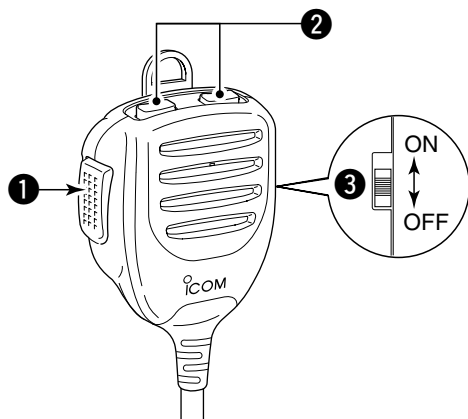

① PTT SWITCH

Hold down to transmit, release to receive.

② UP/DOWN KEYS [UP]/[DN]

- Push either key to change the operating frequency, memory channel, Set mode setting, and so on. (p. 3-9, FM sec. 4, 11)
- Hold down either key for 1 second to start scanning.

③ UP/DN LOCK SWITCH

Slide to turn the [UP]/[DN] keys lock function ON or OFF.

The optional OPC-589 cable is required to connect these 8-pin microphones.

◇ SM-50 (Option)

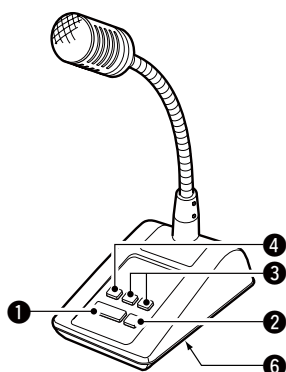

◇ SM-30 (Option)

TOP VIEW

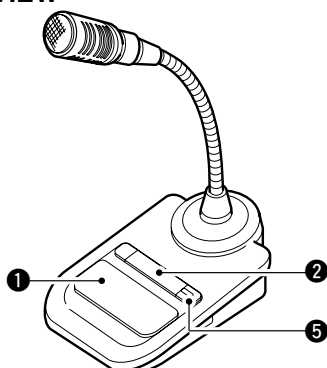

BOTTOM VIEW

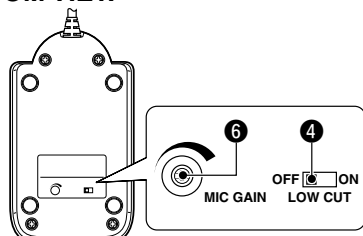

① PTT SWITCH

Hold down to transmit, release to receive.

② PTT LOCK SWITCH

Push to lock the PTT switch in the transmit mode.

③ UP/DOWN SWITCHES [UP]/[DN]

Change the selected readout frequency or memory channel.

- Holding down continuously changes the frequency or memory channel number.
- While holding down [XFC], the transmit readout frequency can be controlled while in the split frequency mode.
- The [UP]/[DN] switch can simulate a key paddle. Preset in the "KEYER SET" mode (U/D KEY; MIC Up/Down Keyer). (FM sec. 4)

④ LOW CUT SWITCH

Push (SM-50)/Slide (SM-30) to cut out the low frequency components of input voice signals.

⑤ PTT LOCK INDICATOR [LOCK]

(Only for the SM-30)

Lights red when the PTT lock switch (②) is ON.

⑥ MIC GAIN VOLUME [MIC GAIN]

Rotate to adjust the microphone output level.

- Use this control as an addition to the microphone gain setting of the connected transceiver.

⚠ Rotating the control too far clockwise may result in an output level that is too high and transmit signal distortion.

◇ HM-151 (Option)

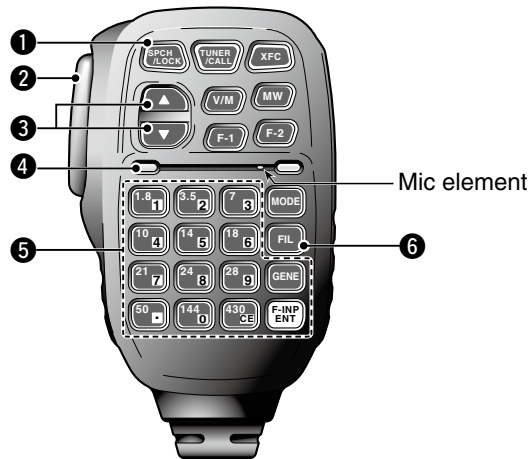
**1 SPCH/LOCK KEY [SPCH/LOCK]**

○ SPEECH KEY Operation (p. 3-20)

Push to audibly announce the S-meter level, the displayed frequency and the operating mode.

- The S-Level announcement can be turned OFF in the “S-Level SPEECH” item of the “SPEECH” Set mode. (p. 6-4)

[SET] > SPEECH > S-Level SPEECH

- When RIT is ON, the RIT offset is not included in the frequency announcement.

○ LOCK KEY Operation (FM sec. 5)

Hold down for 1 second to turn the Lock function ON or OFF.

- The function electronically locks the Dial.
- “” appears when the function is ON.
- You can select the Dial lock and Panel lock in the “Lock Function” item of the “Function” Set mode (p. 6-6).

[SET] > Function > Lock Function

2 PTT SWITCH [PTT] (p. 3-23)

Hold down to transmit, release to receive.

3 UP/DOWN KEYS [▲]/[▼]

Change the operating frequency.

- Hold down to continuously change the frequency.
- If the Quick tuning icon is not displayed, the tuning step is 50 Hz.

4 TRANSMIT LED

Lights red while transmitting.

5 KEYPAD

- Pushing a key selects the operating band.
 - **[(GENE)•]** selects the general coverage band.
- Pushing the same key 2 or 3 times calls up other stacked frequencies in the band.
 - Icom’s triple band stacking register memorizes 3 frequencies in each band.
- After pushing **[(F-INP)ENT]**, enter a numeric frequency, then press **[(F-INP)ENT]** again.
 - Example: To enter 14.195 MHz, push **[(F-INP)ENT] [1] [4] [•] [1] [9] [5] [(F-INP)ENT]**.

6 FILTER SELECTION KEY [FIL]

- Push to select one of three IF filter settings.
 - The selected filter passband width and shifting value are displayed for 2 seconds in the window.
- Push for 1 second to display the “FILTER” screen to adjust the filter passband width.
- When the “FILTER” screen is displayed, push for 1 second to return to the previous screen.

Microphone

◇ HM-151 (Option) (Continued)

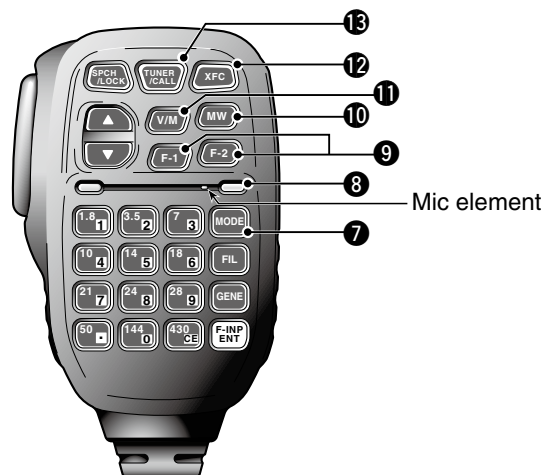

7 MODE KEY [MODE]

- Push to cycle through the operating modes:
USB/LSB ▶ CW/CW-R ▶ RTTY/RTTY-R ▶ AM
▶ FM ▶ WFM ▶ DV
- Hold down for 1 second to toggle the following operating modes:
USB ↔ LSB
CW ↔ CW-R
RTTY ↔ RTTY-R

8 POWER LED

Lights green when transceiver's power is ON.

9 PROGRAMMABLE FUNCTION KEYS [F-1]/[F-2]

Program and perform a selected function.

- The functions can be assigned in the "RC MIC" item of the "Function" Set mode (p. 6-6). The default settings for [F-1] and [F-2] are "MPW" and "MPR."

[SET] > Function > **RC MIC**

10 MEMORY WRITE KEY [MW] (FM sec. 11)

Hold down for 1 second to store VFO data into the selected memory channel.

- This can be done in both the VFO and memory modes.

11 VFO/MEMORY SELECTION KEY [V/M]

- Push to switch between the VFO and memory modes. (p. 3-4)
- Hold down for 1 second to copy the memory contents to the displayed VFO. (FM sec. 11)

12 TRANSMIT FREQUENCY CHECK KEY [XFC]

- During split frequency or repeater operation, hold down to listen to the transmit frequency. (FM sec. 4)
 - While holding down this switch, the transmit frequency can be changed with the Dial or [MPAD].
 - When the Split Lock function is turned ON in the Split operation, hold down [XFC] to cancel the Dial lock function. (FM sec. 6)
- When operating simplex, hold down to monitor the frequency.
 - While holding down this key, the squelch is open and the interference reject function is temporarily turned OFF.
- When operating simplex and the RIT function is turned ON, hold down to listen to the transmit frequency. The frequency is the same as when the RIT is OFF. (FM sec. 5)
- In the DV mode, hold down this key to select the RX monitoring mode. (p. 6-3)

13 TUNER/CALL KEY [TUNER/CALL]

- ANTENNA TUNER KEY Operation (FM sec. 16)
(Frequency band: HF/50 MHz)
 - Push to turn an optional antenna tuner ON or OFF (bypass).
 - Hold down for 1 second to manually start the antenna tuner.
 - If the tuner cannot tune the antenna within 20 seconds, the tuning circuit is automatically bypassed.
- CALL KEY Operation (FM sec. 11)
(Frequency band: 144/430 MHz)
Push to select the Call channel.

In the 70 MHz band, push to sound an error beep.

Section 2

INSTALLATION AND CONNECTIONS

Selecting a location.....	2-2
Grounding	2-2
Antenna connection.....	2-2
Connect controller to transceiver	2-3
◇ The Main unit installation.....	2-3
Connect to the controller.....	2-4
Required Connections to a Transceiver	2-5
The External Units Connections to a Transceiver	2-6
Power Supply Connections	2-7
◇ Connecting the PS-126 power supply	2-7
◇ Connecting a non-Icom DC power supply	2-7
Linear Amplifier Connections	2-8
◇ Connecting the IC-PW1/EURO	2-8
◇ Connecting a non-Icom linear amplifier.....	2-8

Section 1 PANEL DESCRIPTION

Section 2 INSTALLATION AND CONNECTIONS

Section 3 BASIC OPERATION

Section 4 D-STAR INTRODUCTION

Section 5 D-STAR OPERATION <BASIC>

Section 6 SET MODE

Section 7 INFORMATION

'FM' means 'Full Manual.'
'sec. * *' means section number.

So when '(FM sec. * *)' is described on this manual, see the PDF type Full Manual's section number for your reference.

Selecting a location

Select a location for the transceiver that allows adequate air circulation, free from extreme heat, cold, vibrations, away from TV sets, TV antenna elements, radios and other electromagnetic sources.

The base of the transceiver has adjustable feet for desktop use. Set the feet to one of two angles, to meet your operating preference.

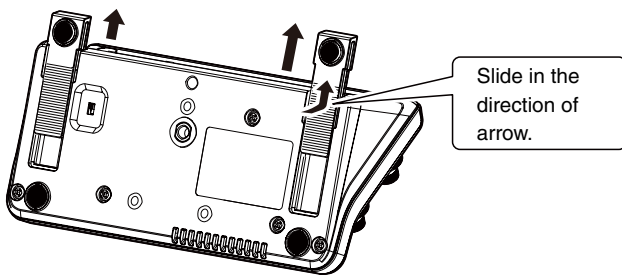

Controller bottom view

Grounding

To prevent electrical shock, television interference (TVI), broadcast interference (BCI) and other problems, ground the transceiver using the GROUND terminal on the rear panel.

For best results, connect a heaviest gauge wire or strap to a long ground rod. Make the distance between the [GND] terminal and ground as short as possible.

WARNING! NEVER connect the [GND] terminal to a gas or electric pipe, since the connection could cause an explosion or electric shock.

Antenna connection

For radio communications, the antenna is of critical importance, along with output power and receiver sensitivity. Select a well-matched 50 Ω antenna and coaxial cable feedline. We recommend 1.5:1 or better of Voltage Standing Wave Ratio (VSWR) on your operating bands. The transmission line should be a coaxial cable. When using a single antenna (for the HF, 50/70 MHz bands), use the [ANT1] connector.

CAUTION: Protect your transceiver from lightning by using a lightning arrester.

Antenna SWR

Each antenna is tuned for a specified frequency range and the SWR usually increases outside the range. When the SWR is higher than approximately 2.0:1, the transceiver automatically reduces the TX power to protect the final transistors. In that case, an antenna tuner is useful to match the transceiver and antenna. Low SWR allows full power for transmitting. The IC-7100 has an SWR meter to continuously monitor the antenna SWR.

Antenna connection

Connect the cable from an HF, 50/70 MHz antenna to the [ANT 1] connector.

Connect the cable from a 144/430MHz antenna to the [ANT 2] connector.

Connect controller to transceiver

The Main unit becomes hot when transmitted for long period of time.

DO NOT place anything on the transceiver. It may obstruct radiation and cause mechanical trouble.

Using Ferrite EMI filter*

Depending on the installed condition of the transceiver, malfunction may occur by the wraparound of the electric wave. This problem can be resolved by using the Ferrite EMI filter.

* The filter connection is required for the European versions.

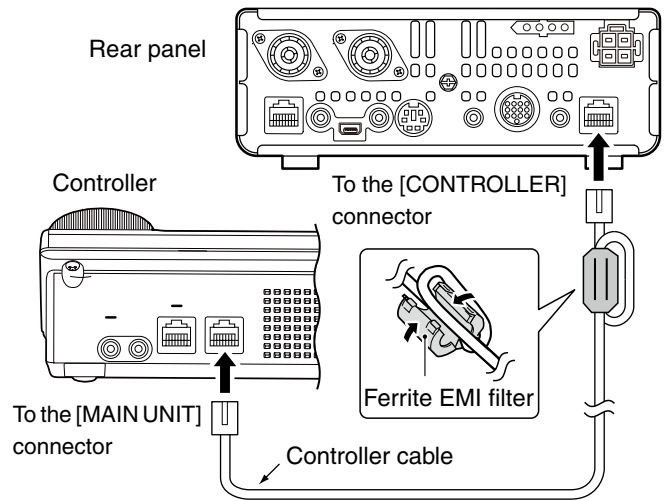

◇ The Main unit installation

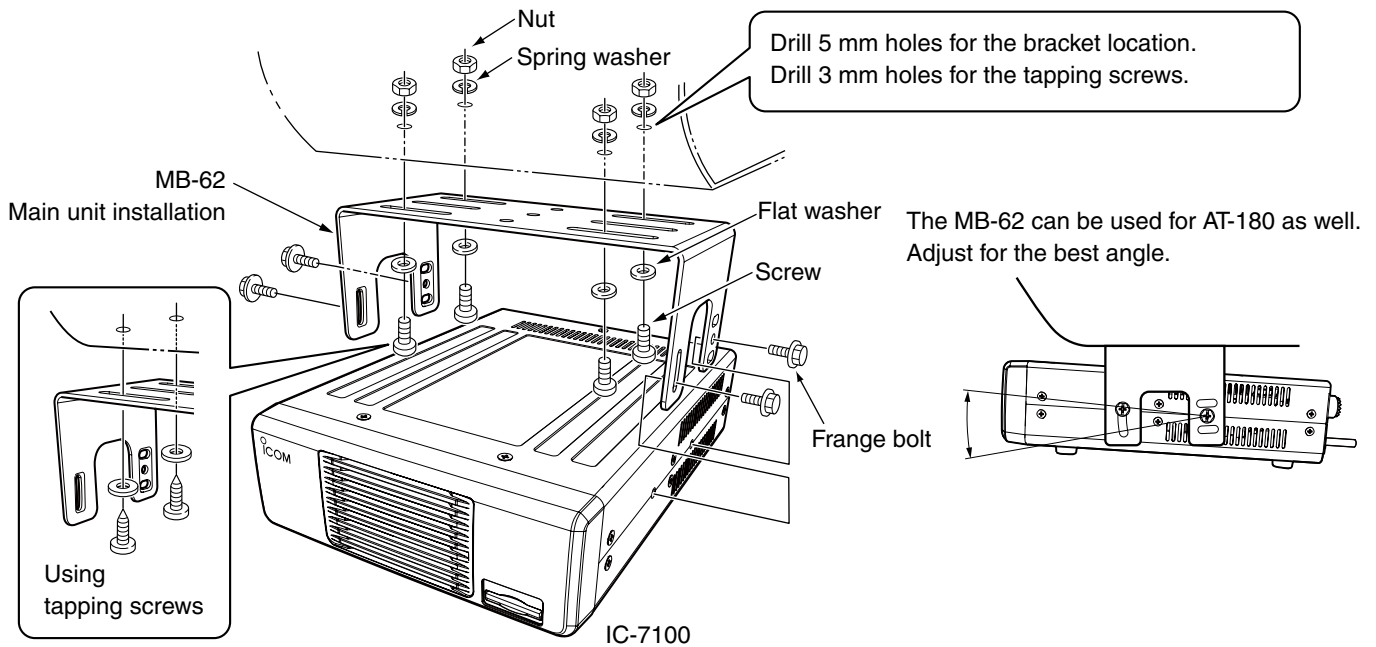

Connecting accessories to the controller

[MIC] Connector

HM-151

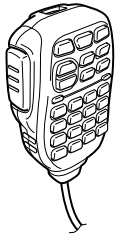

HM-198



Adapter cable+Microphone

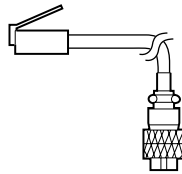

OPC-589



HM-36

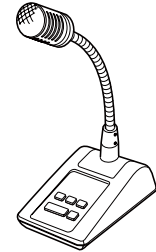

SM-50

Do not connect 2 microphones at same time. Both microphone have transmission if they are connected to controller and transceiver.

CAUTION: NEVER connect or use the optional HM-151 (microphone) with any other transceiver. This could damage the transceiver. The HM-151 is designed to use with the IC-7000/ IC-7100 series ONLY.

• **External Keypad**

Control the CW memory keyer transmission from external keypad by connecting control circuit to MIC connector. Set the "Keyer" item in the "Connectors" Set mode to "ON," to use external keypad. (FM sec. 17)

• **Data transmission (AFSK)**

Connect TNC (Terminal Node Controller) to [MIC] connector to enable data transmission (AFSK). (FM sec 18)

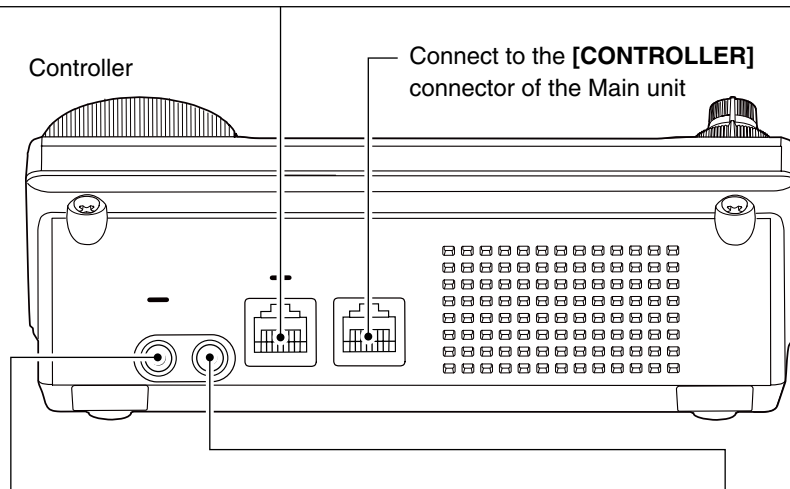

[PHONES/SP] (Headphone/External Speaker) Jack

Set the switch under controller to "PHONES" to use headphone and set "SP" to use speaker.

Bottom of the controller



External speaker

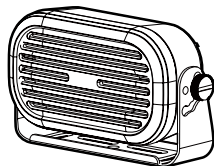

SP-35 (optional)

The transceiver accepts headphones with maximum 5 mW in to an 8 Ω impedance. The sound level may differ, depending on the headphones.

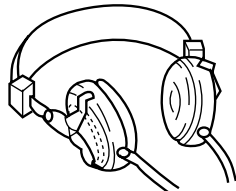

3.5(d) mm/1/8" plug

Headphone

[ELEC-KEY] (Electronic keyer) Jack

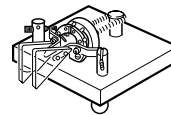

dash

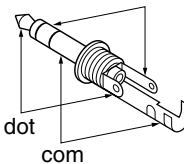

3.5(d) mm/1/8" plug

A jack to connect the paddle with electrode control on the end terminal.

Connect to the [KEY] Jack of the Main unit when using an Electric keyer. (p. 2-5)

※Set internal keyer in default but it can be changed by the "Keyer" Set mode (FM sec. 4)

Required Connections to a Transceiver

[ANT2] 144/430MHz BANDS CONNECTOR (p. 2-2)

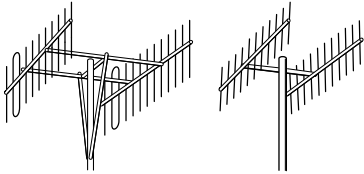

Connect a 50 Ω antenna for the 144/430 MHz frequency bands or 74.8 MHz and above.

[ANT1] HF, 50/70 MHz BANDS CONNECTOR (p. 2-3)

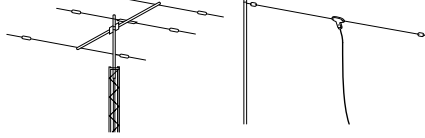

Connect a 50 Ω antenna for the HF, 50/70 MHz frequency bands or below 74.8 MHz.

[DC 13.8V] DC POWER SUPPLY (p. 2-7)

PS-126 (Optional)

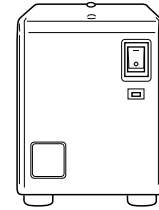

Use a power supply with 13.8 V DC output and a capacity of at least 22 Amperes.

IC-7100

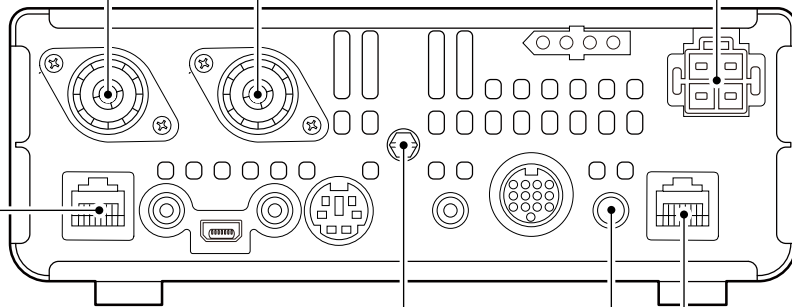

[MIC] MODULAR MICROPHONE CONNECTOR (p. 2-4)

As with a microphone connector of the controller, accepts the supplied microphone.

[GND] GROUND TERMINAL (p. 2-2)

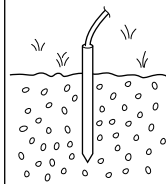

Connect this terminal to a station or vehicle ground to prevent electrical shocks, TVI, BCI and other problems.

STRAIGHT KEY JACK

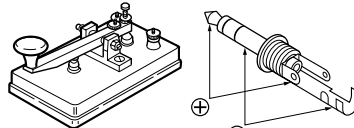

Plug diameter: 3.5 mm/1/8"
Accepts a straight key or an external electronic keyer.

Connect to the [MAIN UNIT] connector of the Controller. (p. 2-4)

The External Units Connections to a Transceiver

[DATA1] DATA1 JACK

For GPS operation (FM sec. 10)

- Connect a GPS receiver to the transceiver.
- The optional OPC-1529R (Data communication cable) and a 3rd party's GPS receiver with RS-232C Port are required.

OPC-1529R
(Optional)



For low-speed data communication in the DV mode (FM sec. 9)

- Connect the transceiver to a PC.
- The USB cable can also be used for low-speed data communication..

[TUNER] TUNER CONTROL SOCKET (FM sec.16)

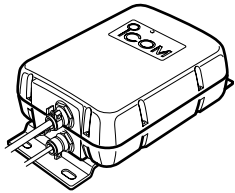

AH-4 (Optional)

Connect the control cable from an optional AH-4 or AH-740 (Automatic antenna tuner).

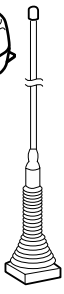

AH-2b (Optional)

- Connected to AH-4

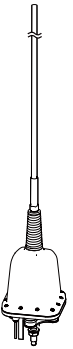

AH-740 (Optional)

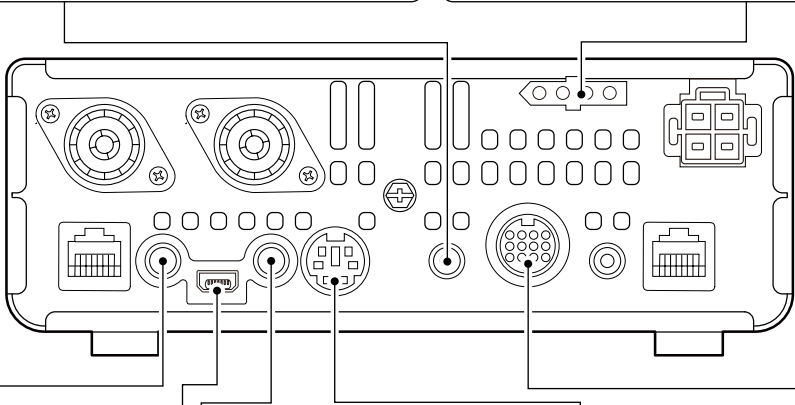

[SP] (EXTERNAL) SPEAKER JACK (p. 2-4)

Similar to the [PHONES/SP] jack on the controller. Plug in an external speaker. 3.5(d) mm/1/8" plug

[DATA2] DATA2 SOCKET (FM sec. 18)

Connect a TNC (Terminal Node Controller) for packet communication.

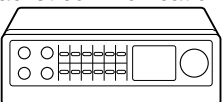

[ACC] ACCESSORY SOCKET (p. 1-16)

Connect control lines for external equipment such as TNC or a PC.

[USB] USB (Universal Serial Bus) PORT

- Remotely control the transceiver using CI-V commands (FM sec. 20)
- Send the received audio to the PC
- Input modulation (pp. 1-15, 6-8)
- Send the decoded RTTY outputs to the PC
- Low-speed data communication in the DV mode (FM sec. 9)
- Cloning using the optional CS-7100 CLONING SOFTWARE (FM sec. 19)
- Remotely control using the optional RS-BA1

[REMOTE] REMOTE CONTROL JACK

- Remotely control the transceiver using CI-V commands. (FM sec. 20)
- Cloning between transceivers (FM sec.19) 3.5(d) mm/1/8" plug

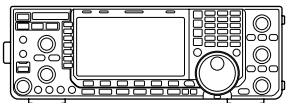
NOTE: By setting "ACC/USB output selection" of the Connectors Set mode (FM sec. 17), the receiving tone can normally be output from the [ACC] socket, and the [USB] port can output an IF signal (12 kHz). This is required for the Software-Defined Radio (SDR) operation. The Digital Radio Mondiale (DRM) broadcast can be received using SDR.

CAUTION: DO NOT connect any device to [REMOTE] when cloning using the optional CS-7100 CLONING SOFTWARE.

Power Supply Connections

Make sure the [PWR] (L) switch is OFF before connecting the DC power cable.

- We recommend using Icom's optional power supply (PS-126: DC13.8 V/25 A).

◇ Connecting the PS-126 power supply

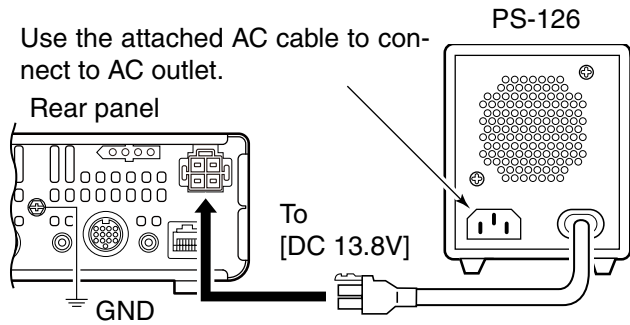

The transceiver needs followings:

- DC 13.8 V (Capacity: 22 A and over)
- A power supply with an over current protective line and with a less voltage fluctuation or ripple

◇ Connecting a non-Icom DC power supply

Connect the black DC power cable to the (-) Negative terminal, and the red DC power cable to the (+) Positive terminal.

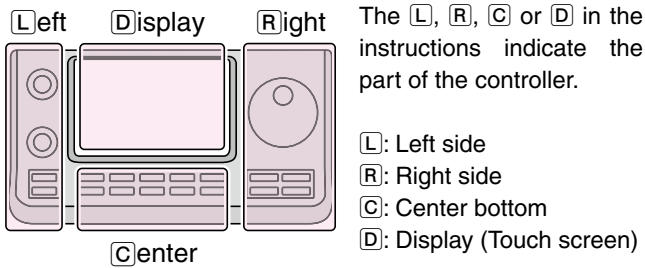
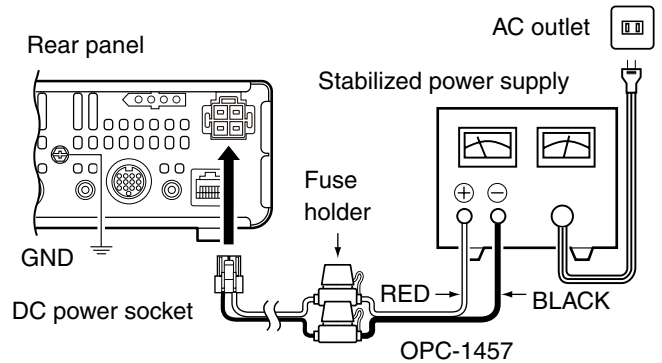

For European versions

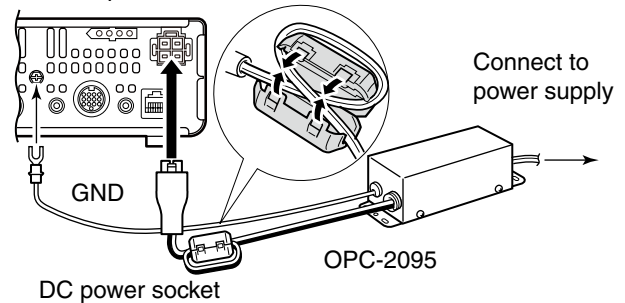

⚠ WARNING! (About DC power supply)

- Make sure DC power cable polarity is correct.
Red: Positive + terminal
Black: Negative - terminal
- **NEVER** cut the DC power cable between the DC plug and fuse holder.
- **DO NOT** use unattached or undesignated DC power cable.
- **DO NOT** forcibly pull or bend the DC power cable. Install the devices far enough from the place where people might put things or step on the DC power cable.

Linear Amplifier Connections

◇ Connecting the IC-PW1/EURO

To connect the Icom IC-PW1/EURO, see the diagram below.
For IC-PW1/EURO operation, refer to the amplifier's instruction manual.

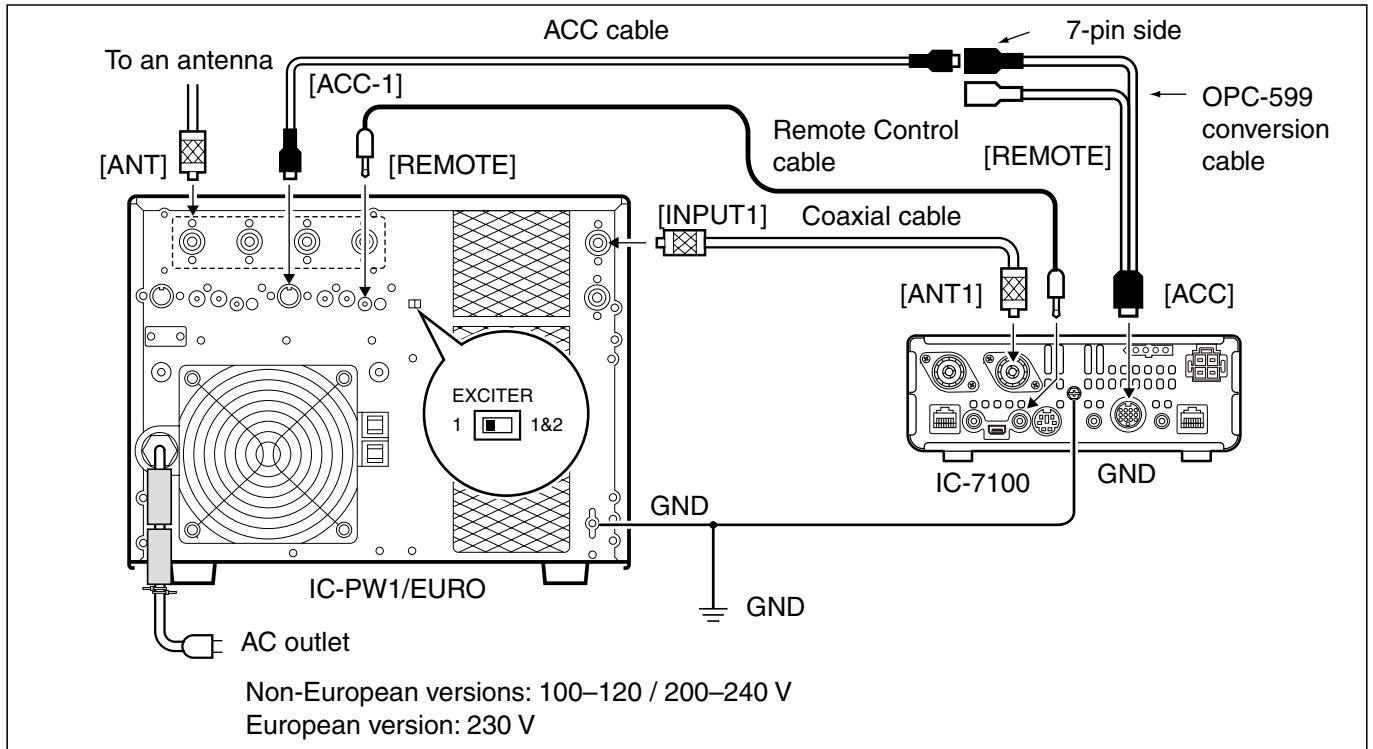

◇ Connecting a non-Icom linear amplifier

To connect a non-Icom HF, 50/70*1 MHz bands linear amplifier, see the diagram below.

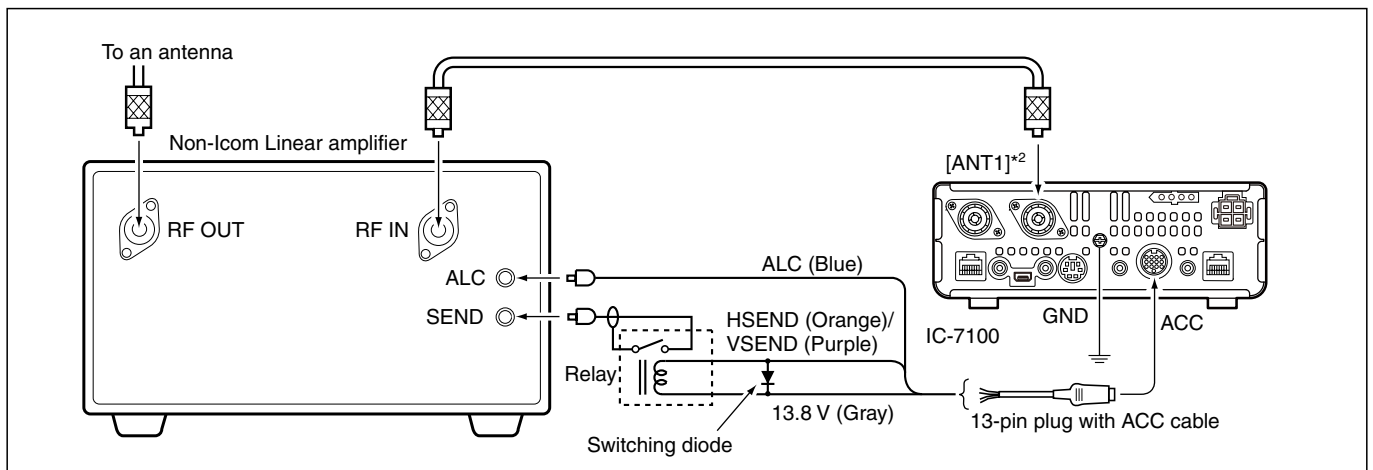

When using a linear amplifier that has a time delay between receiving and transmitting, a high SWR might cause the linear amplifier to malfunction. To prevent this, slow the TX Delay in the "TX Delay (HF), (50M), (144M), (430M)" items of the "Function" Set mode. (p. 6-5)

SET(C) > Function > **TX Delay**

*1 70 MHz band transmission is available, depending on the transceiver version.

*2 When connecting a 144 MHz or 430 MHz band's linear amplifier, connect to [ANT2].

Section 3

BASIC OPERATION

Power ON.....	3-2
◇ Before first applying power.....	3-2
◇ Turning ON the power	3-2
Selecting a Function menu.....	3-3
Selecting VFO/Memory mode	3-4
VFO operation.....	3-5
◇ Selecting VFO A or VFO B	3-5
◇ VFO equalization.....	3-5
Selecting a frequency band.....	3-6
◇ Using the band stacking registers	3-6
Setting frequency	3-7
◇ Tuning with the Dial	3-7
◇ Quick Tuning function	3-8
◇ Selecting 'kHz' step	3-9
◇ Selecting 1 Hz step	3-9
◇ 1/4 tuning step function	3-10
◇ Auto tuning step function.....	3-10
◇ Direct frequency input	3-11
◇ Band edge warning beep	3-13
◇ Programming the user band edge.....	3-14
Selecting the Operating mode.....	3-17
Selecting the Audio volume.....	3-18
Squelch and receive (RF) sensitivity	3-19
Voice synthesizer operation	3-20
◇ Turning OFF the S-meter announcement.....	3-21
◇ Turning ON the MODE announcement	3-21
Meter display selection	3-22
Basic transmit operation	3-23
◇ Transmitting.....	3-23
◇ Microphone gain adjustment	3-24

Section 1 PANEL DESCRIPTION

Section 2 INSTALLATION AND CONNECTIONS

Section 3 BASIC OPERATION

Section 4 D-STAR INTRODUCTION

Section 5 D-STAR OPERATION <BASIC>

Section 6 SET MODE

Section 7 INFORMATION

Power ON

◇ Before first applying power

Before turning ON your transceiver for the first time, make sure all connections required for your system are complete by reviewing them in Section 2 of this manual.

After all connections have been made, set the [AF] (L) and [RF/SQL] (L) controls as shown in the illustration to the right.

NOTE: When turning OFF the power, the transceiver memorizes the settings. Thus the transceiver restarts with the settings before you turned OFF the power.

[RF/SQL] control: 12 o'clock

[AF] control: Max counterclockwise

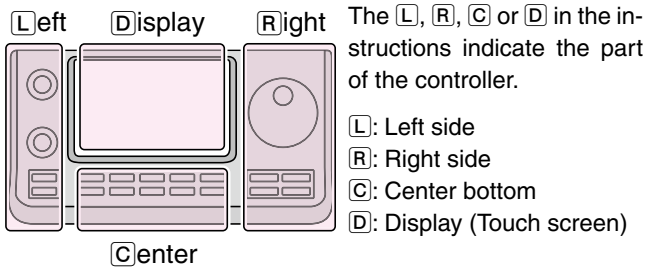

◇ Turning ON the power

Normal Power ON:

Push [PWR] (L) to turn ON the transceiver.

Power OFF:

Hold down [PWR] (L) for 1 second to turn OFF the transceiver.

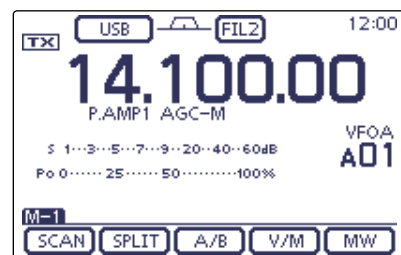
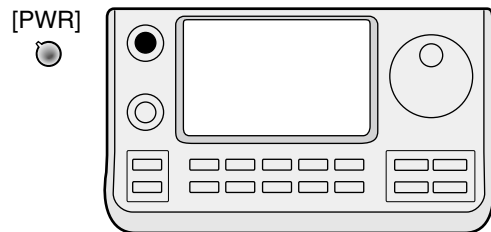

Initial VFO display

Partial Resetting

A partial resetting **CLEARs** the operating parameters and returns them to their default values (VFO frequency, VFO settings, menu group's contents) without clearing certain data.

[SET] (C) > Others > Reset > **Partial Reset**

- During start-up, the transceiver displays "PARTIAL RE-SET," then its initial VFO frequencies when resetting is complete.

See the PDF type Full Manual's Section 19 for resetting details.

Selecting a Function menu

Push **MENU**(**C**) one or more times to select the “M-1” screen (M-1 menu), “M-2” screen (M-2 menu) or “M-3” screen (M-3 menu).

- In the DR mode, push **MENU**(**C**) once or twice to select the “D-1” screen (D-1 menu) or “D-2” screen (D-2 menu).
- Functions vary, depending on the operating mode.
(p. 1-10 to p. 1-12)

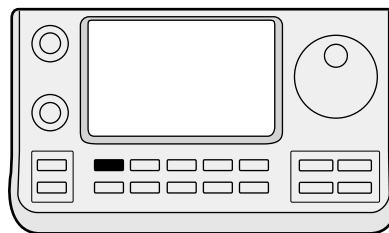

MENU

Left **D**isplay **R**ight The **L**, **R**, **C** or **D** in the instructions indicate the part of the controller.

Center

- L**: Left side
- R**: Right side
- C**: Center bottom
- D**: Display (Touch screen)

Example: Menu selection in the SSB mode

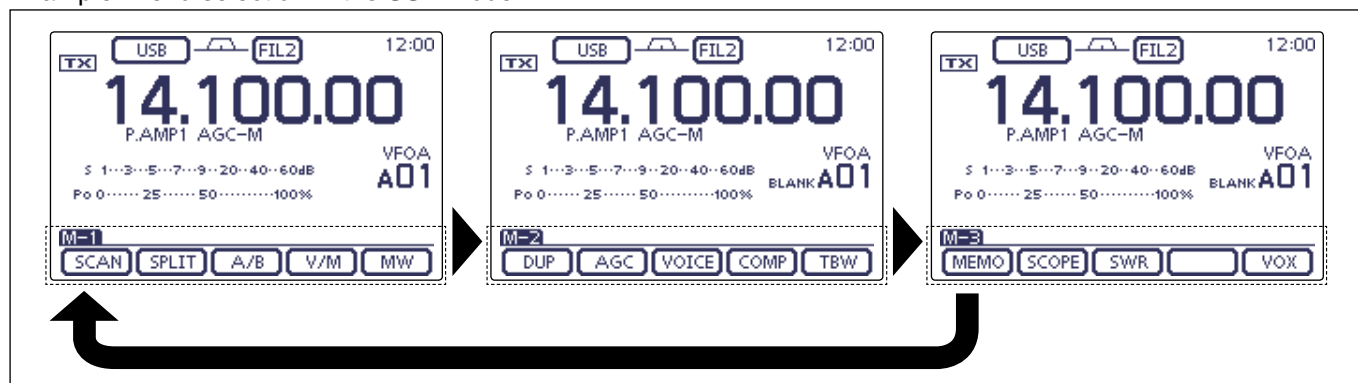

Selecting VFO/Memory mode

IC-7100 has VFO and Memory modes.
 In the VFO mode, rotate the Dial to select the desired frequency.
 In the Memory mode, rotate [M-CH] (L) to select the preprogrammed memory channel.

Push **MENU** (C) one or more times to select the “M-1” screen (M-1 menu).

- Touch **[V/M]** (D) to select the VFO or memory mode.
- Touch **[V/M]** (D) for 1 second to copy the selected memory channel contents to the VFO mode. (See the PDF type Full Manual’s Section 11 for details.)

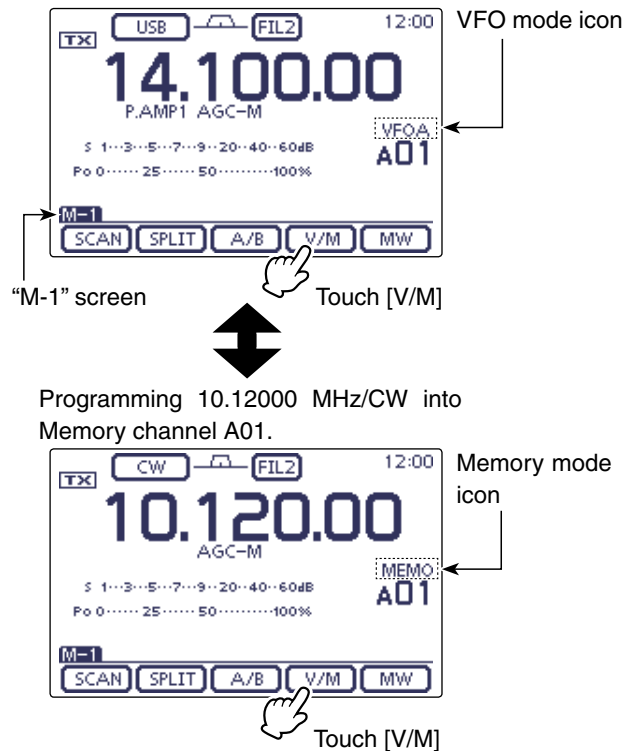

Touching the VFO/Memory mode icon or Memory channel selects the VFO or Memory mode.

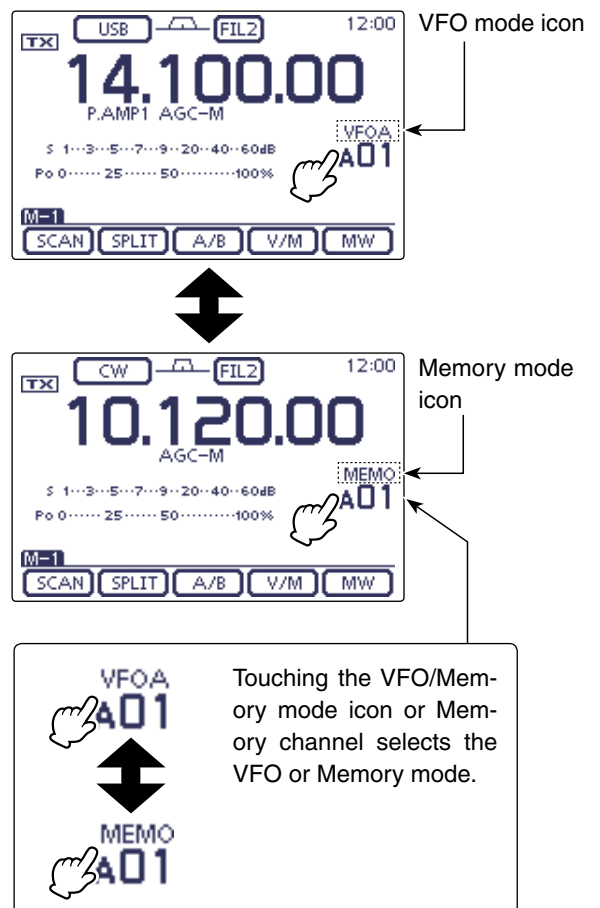
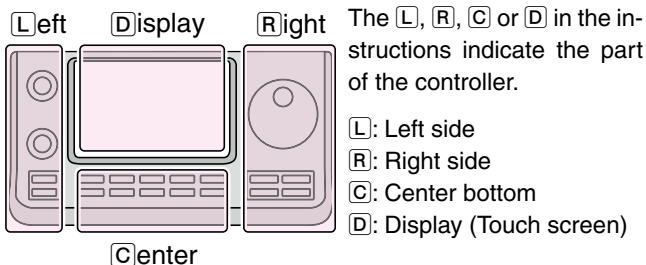

VFO operation

The IC-7100 has two VFOs; “A” and “B,” and are convenient for quickly selecting two frequencies, or split frequency operation. You can use either VFO to call up a frequency and operating mode. VFO is an abbreviation of Variable Frequency Oscillator.

◇ Selecting VFO A or VFO B

- ① While in the VFO mode, push **MENU**(C) one or more times to select the “M-1” screen (M-1 menu).
- ② Touch **[A/B]**(D) to switch between the VFO A and VFO B.
 - “VFOA” or “VFOB” appears as each VFO is selected.

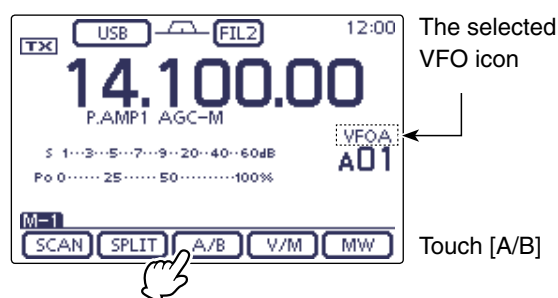
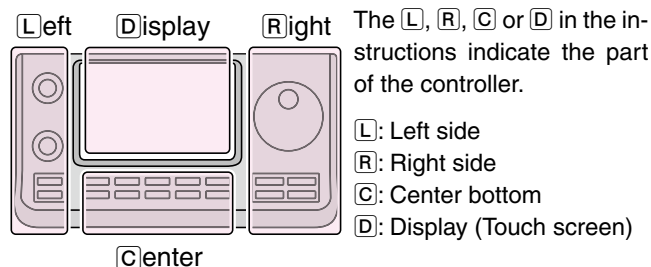

◇ VFO equalization

- ① Push **MENU**(C) one or more times to select the “M-1” screen (M-1 menu).
- ② Touch **[A/B]**(D) for 1 second to equalize the data in both VFOs.
 - Three beeps sound when the equalization is complete.
- ③ Touch **[A/B]**(D) to select the other VFO.
 - Selects VFO A or VFO B to display the VFO’s frequency.

Example: Equalize VFO B to VFO A

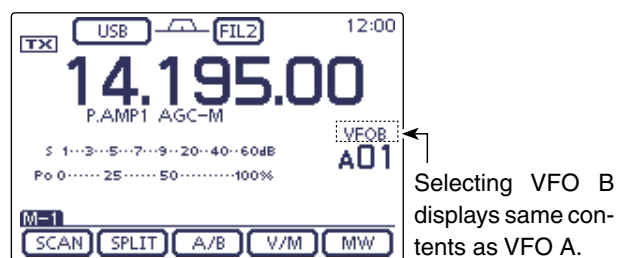
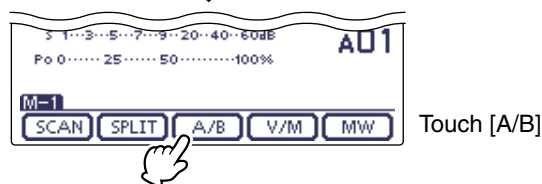
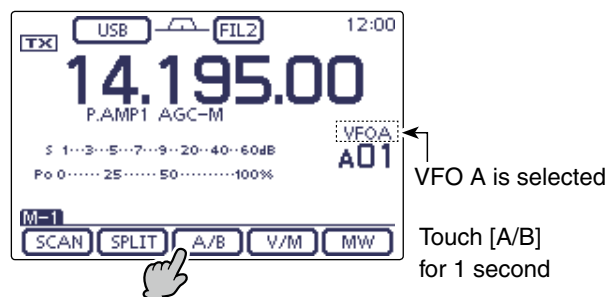

CONVENIENT!

Use two VFOs as quick memories:

When you find a new station, but wish to continue searching, the dual VFO system can be used for quick memory storage.

- ① Touch **[A/B]**(D) for 1 second to store the displayed contents into the undisplayed VFO.
- ② Continue searching for stations.
- ③ Touch **[A/B]**(D) to show the stored contents of the undisplayed VFO.
- ④ To continue searching for stations, touch **[A/B]**(D) again to show the previous VFO.

Selecting a frequency band

Select the frequency band you want to use.

- ① Touch the MHz digits of the frequency readout to enter the Band selection screen.
- ② Touch a desired operating band, “1.8” to “430” or “GENE.”
 - After touching the band, the display moves to the selected band, and returns to the frequency display.
 - Touch a band for 1 second to select the Band stacking register, Register 1, Register 2 or Register 3 on the Band selection screen.
 - Touch [F-INP] to enter the Direct input screen. (p. 3-11)
 - If desired, touch [↩](D) or push [MENU](C) to exit the screen.

◇ Using the band stacking registers

The triple band stacking register provides 3 memories for each band key to store frequencies and operating modes.

This function is convenient when you operate 3 operating modes on one frequency band.

For example, one register can be used for a CW frequency, another for an SSB frequency and the other one for an RTTY frequency.

If a band key or [GENE] is touched for 1 second once, the last used frequency and operating mode are called up. When the key is touched for 1 second again, another stored frequency and operating mode are called up.

See the table below for a list of the available frequency bands and their default frequency and mode settings.

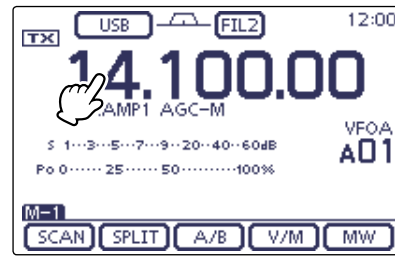

Touch the MHz digits.

• Band selection screen

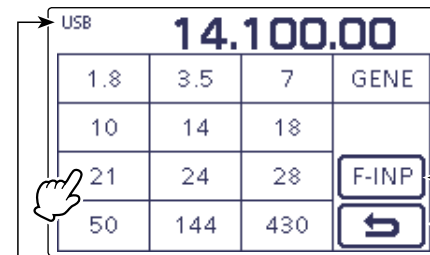

Operating mode

Example: Touch “21” in the above screen

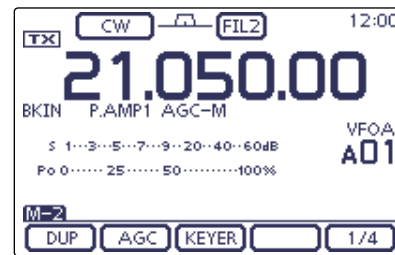

The **L**, **R**, **C** or **D** in the instructions indicate the part of the controller.

- L**: Left side, **R**: Right side, **C**: Center bottom
- D**: Display (Touch screen)

BAND	REGISTER 1	REGISTER 2	REGISTER 3
1.8 MHz*1	1.900000 MHz CW	1.910000 MHz CW	1.915000 MHz CW
3.5 MHz*1	3.550000 MHz LSB	3.560000 MHz LSB	3.580000 MHz LSB
7 MHz	7.050000 MHz LSB	7.060000 MHz LSB	7.020000 MHz CW
10 MHz*1	10.120000 MHz CW	10.130000 MHz CW	10.140000 MHz CW
14 MHz	14.100000 MHz USB	14.200000 MHz USB	14.050000 MHz CW
18 MHz	18.100000 MHz USB	18.130000 MHz USB	18.150000 MHz USB
21 MHz	21.200000 MHz USB	21.300000 MHz USB	21.050000 MHz CW
24 MHz	24.950000 MHz USB	24.980000 MHz USB	24.900000 MHz CW
28 MHz	28.500000 MHz USB	29.500000 MHz USB	28.100000 MHz CW
50 MHz*1	50.100000 MHz USB	50.200000 MHz USB	51.000000 MHz FM
144 MHz	145.000000 MHz FM	145.100000 MHz FM	145.200000 MHz FM
430 MHz*1	433.000000 MHz FM	433.100000 MHz FM	433.200000 MHz FM
General*1, 2	15.000000 MHz USB	15.100000 MHz USB	15.200000 MHz USB

*1 The default frequency and mode settings differ depending on the version. Above list shows the USA version's.

*2 [GENE] selects the general coverage band.

Setting frequency

You can select the transceiver's frequency by using the Dial, or you can enter it on the Direct input screen.

◇ Tuning with the Dial

- ① On the Band selection screen, select the desired frequency band. (p. 3-6)
- ② Rotate the Dial to set the desired frequency.
 - The default tuning step differs, depending on the operating mode, frequency band and a version.

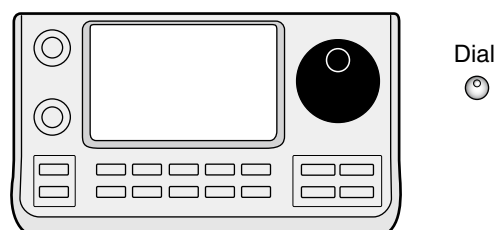

If the frequency cannot be changed:

Check the Lock function, and if it is ON, "LOCK" is displayed, and the Dial does not function. In this case, hold down **[SPEECH/LOCK]**(R) for 1 second to turn OFF the Lock function.

When "LOCK/SPEECH" is selected in the "[SPEECH/LOCK] Switch" item of the "Function" Set mode, pushing **[SPEECH/LOCK]** turns OFF the lock function. (p. 6-6)

[SET](C) > Function > **[SPEECH/LOCK] switch**

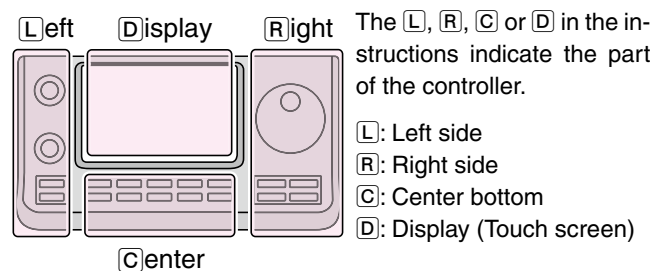

Setting frequency (Continued)

◇ Quick Tuning function

The operating frequency can be changed in 'kHz' or 'MHz' steps for quick tuning.

Select the desired tuning step in each operating frequency band and mode.

① Touch the kHz digits to select the 'kHz' Quick Tuning function step, or turn it OFF. Or touch the MHz digits for 1 second to select the 'MHz' Quick Tuning function step, or turn it OFF.

- While the quick tuning icon "▼" is displayed above the 1 kHz or 1 MHz digit, the frequency will be changed in 'kHz' or 'MHz' steps.

- When the function is OFF, the frequency will be changed in 10 Hz or 1 Hz steps.

② Rotate the Dial to change the frequency in the selected steps.

• 'kHz' Quick Tuning function

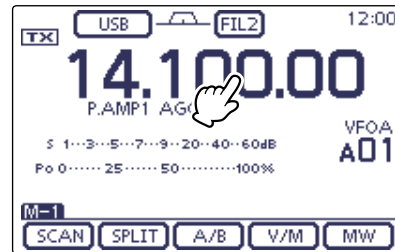

Touch the kHz digits

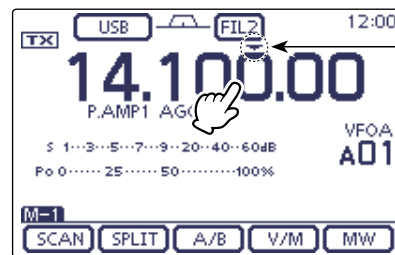

Quick tuning icon

Touch the kHz digits to turn it OFF

• 'MHz' Quick Tuning function

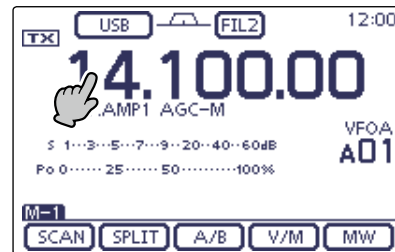

Touch the MHz digits for 1 second

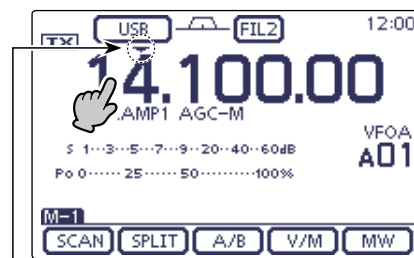

Touch the MHz digits for 1 second to turn it OFF

Quick tuning icon

Setting frequency (Continued)

◇ Selecting 'kHz' step

When the 'kHz' Quick Tuning is selected, the frequency can be changed in the selected 'kHz' steps. The steps can be memorized, depending on the operating modes.

- ① On the Mode selection screen, select the desired operating mode. (p. 3-17)
- ② Touch the kHz digits for 1 second to enter the Tuning step selection screen.
 - The 'kHz' Quick Tuning function is turned ON, and then the "▼" icon is displayed.
- ③ Touch the desired tuning step to select the desired 'kHz' step.
 - 0.1, 1, 5, 6.25, 9, 10, 12.5, 20, 25, 50 and 100 kHz are selectable.
 - If the desired step is not displayed, touch [▲] or [▼](D) to select the page.
 - On the Tuning step selection screen, rotating the Dial also selects the tuning step.
 - If desired, touch [↶](D) or push [MENU](C) to return to the normal operating screen.
- ④ Repeat steps ① to ③ to select the Quick tuning steps for other modes.

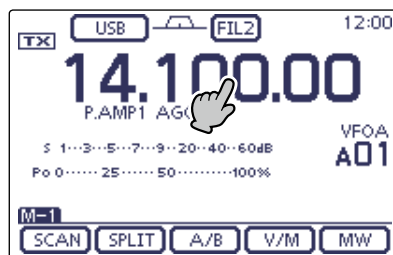

Touch the kHz digits for 1 second

• Tuning step selection screen

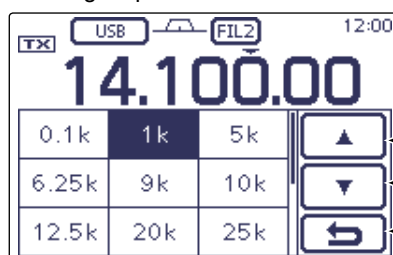

Selects pages
Cancel edit

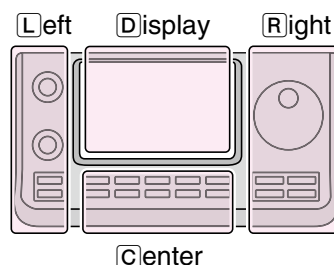

The L, R, C or D in the instructions indicate the part of the controller.

- L: Left side
- R: Right side
- C: Center bottom
- D: Display (Touch screen)

◇ Selecting 1 Hz step

You can change the frequency in 1 Hz steps for fine tuning.

- ➔ Touch the Hz digits for 1 second to turn the 1 Hz tuning step ON or OFF.

NOTE:

- When the RIT function is used, it also tunes in 1 Hz tuning steps.
- The frequency changes in 50 Hz steps when the [UP]/[DN] switches of the microphone are used for frequency tuning (if the quick tuning function is not selected.)

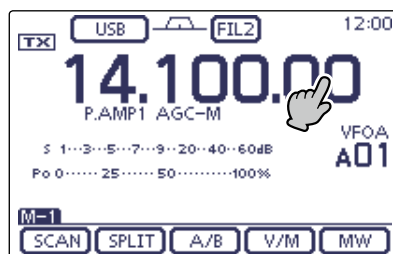

Touch the Hz digits for 1 second

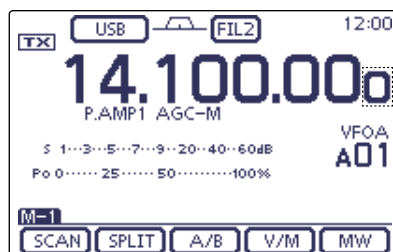

1 Hz indication

Setting frequency (Continued)

◇ 1/4 tuning step function

(Mode: SSB-D/CW/RTTY)

The dial speed is reduced to 1/4 of the normal speed when the 1/4 tuning function is ON, for finer tuning control.

You can set the 1/4 tuning function in each operating frequency band.

This function is selectable only when the quick tuning function is turned OFF.

- ① Push **MENU**(C) one or more times to select the "M-2" screen (M-2 menu).
- ② Touch [1/4](D) to turn the 1/4 tuning function ON or OFF.
 - "1/4" appears when the 1/4 tuning function is ON.

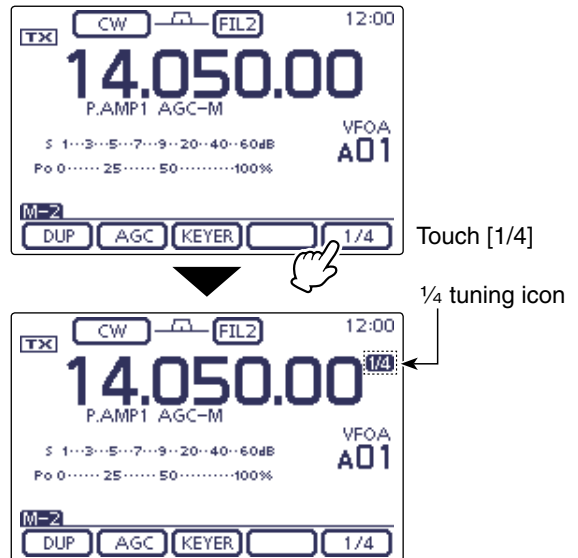

◇ Auto tuning step function

When you rapidly rotate the Dial, the tuning speed can automatically accelerate, depending on the "MAIN DIAL Auto TS" option in the "Function" Set mode.

- ① Push **SET**(C) to enter the Set mode.
- ② Touch the "MAIN DIAL Auto TS" item of the "Function" Set mode.
 - Function > **MAIN DIAL Auto TS**
 - If the specified item is not displayed, touch [▲] or [▼](D) one or more times to select the page.
- ③ Touch the desired option to select the HIGH or LOW tuning speed acceleration, or to turn OFF the function.
 - HIGH: When the tuning step is set to 1 kHz or smaller steps, the tuning speed is approximately five times faster. When the tuning step is set to 5 kHz or larger steps, the tuning speed is approximately two times faster. (default)
 - LOW: Approximately two times faster
 - OFF: Auto tuning step is turned OFF.
 - If desired, touch the item for 1 second to open the Default set window, then select the "Default" to reset to the default setting.
- ④ Push **SET**(C) to exit the Set mode.

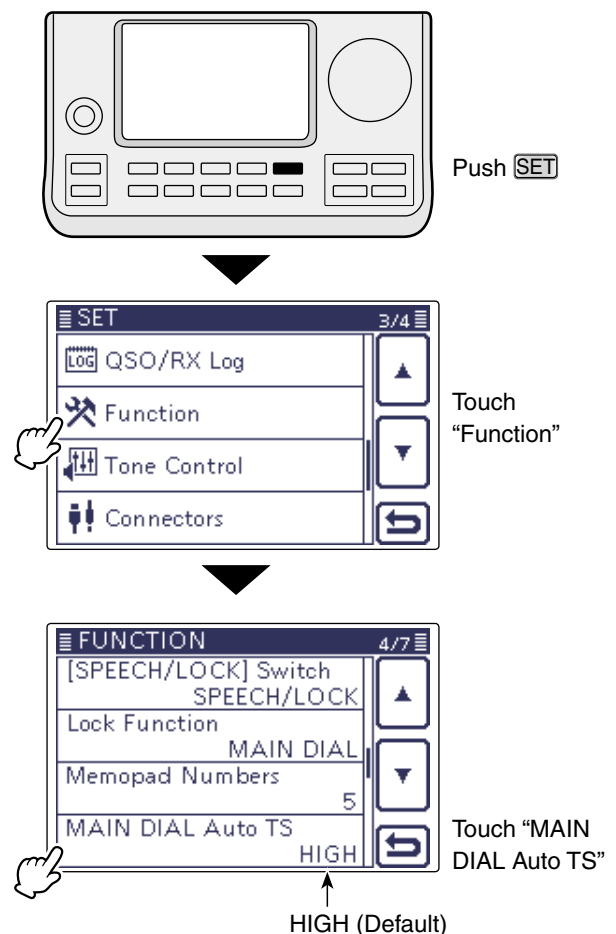

The L, R, C or D in the instructions indicate the part of the controller.
 L: Left side, R: Right side, C: Center bottom
 D: Display (Touch screen)

Setting frequency (Continued)

◆ Direct frequency input

The transceiver has a Direct input screen for direct frequency entry, as described below.

• Operating frequency input

- ① Touch the MHz digits to enter the Band selection display.
- ② Touch [F-INP](D) to enter the Direct input screen.
- ③ Touch the desired number to enter the desired frequency.
 - If a most significant digit is inputted, it will be displayed at the 10 Hz digit, and then next digit is inputted, a display will be shifted to left side one by one.
 - If the numbers for the MHz digits are inputted, and then "." is touched, the inputted numbers will be shifted to the MHz digits.
- ④ Touch [ENT](D) to input the frequency.
 - If a most significant digit is inputted, it will be displayed at the 10 Hz digit, and then next digit is inputted, a display shifts to left side one by one.
 - When not having inputted below a 100 kHz digit, touch [ENT](D) to set all uninputted digits to "0."
 - If desired, touch "CE" to delete entering.
 - If desired, touch [↵](D) or push [MENU](C) to exit the Direct input screen.

[Example]

To enter the 14.025 MHz frequency:

➔ Touch [1], [4], [• (-)], [0], [2], [5] then [ENT].

To enter the 18.0725 MHz frequency:

➔ Touch [1], [8], [• (-)], [0], [7], [2], [5] then [ENT].

To enter the 706 kHz frequency:

➔ Touch [0], [• (-)], [7], [0], [6] then [ENT].

To enter the 5.100 MHz frequency:

➔ Touch [5], [• (-)], [1] then [ENT].

To enter the 7.000 MHz frequency:

➔ Touch [7] then [ENT].

To change the 21.280 MHz to 21.245 MHz:

➔ Touch [• (-)], [2], [4], [5] then [ENT].

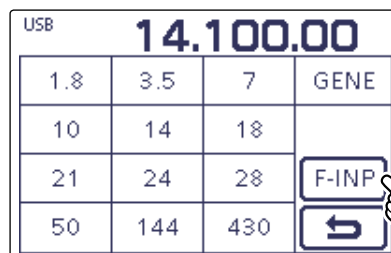
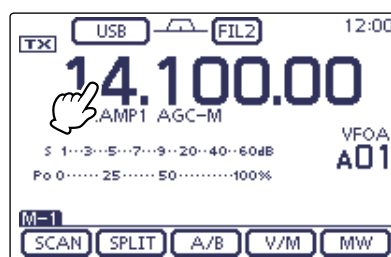
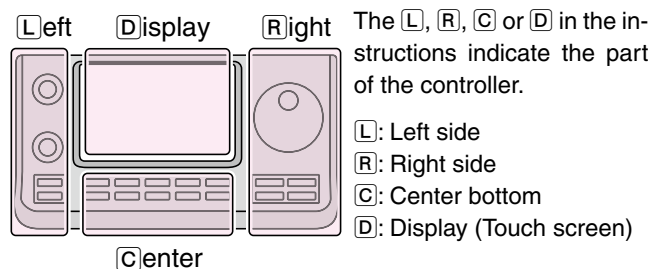

• Direct input screen

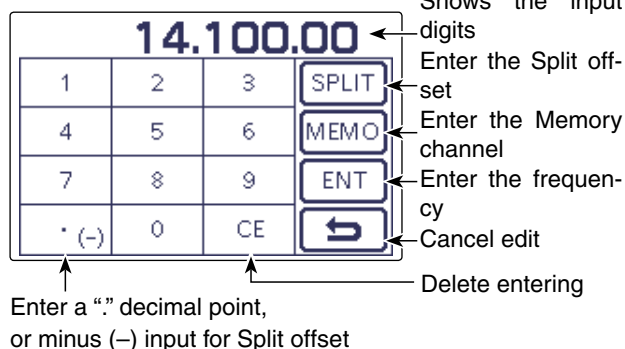

Setting frequency (Continued)

◇ Direct frequency input (Continued)

• **Split offset frequency input**

- ① Touch the MHz digits to enter the Band selection display.
- ② Touch [F-INP](**D**) to enter the Direct input screen.
- ③ If the Shift direction is minus, touch “• (-).”
 - [SPLIT] changes to [-SPLIT], and displays the Minus setting mode.
- ④ Touch the desired number to enter the desired frequency shift.
 - -9.999 to +9.999 MHz can be set in 1 kHz steps.
- ⑤ Touch [SPLIT] or [-SPLIT](**D**) to input the frequency shift to the transmit frequency, and the Split function is turned ON.

[Example]

To transmit on a 10 kHz higher frequency:

➔ Touch [1], [0] then [SPLIT].

To transmit on 1.025 MHz lower frequency:

➔ Touch [• (-)], [1], [0], [2], [5] then [-SPLIT].

• **Memory channel selection**

- ① Open the Direct input screen.
- ② Touch the desired memory channel number.
 - Selectable memory channels are 1 to 99 in the selected memory bank A to E.
 - The memory channels in the other memory banks cannot be selected.
 - Scan edge channels and Call channels can also be selected. (Shown in the table to the right below.)
- ③ Touch [MEMO](**D**) to select the channel.
 - The selected memory channel is displayed, and then exit the Direct input screen.
 - If desired, touch “CE” to delete the entered digits.
 - If desired, touch [↵](**D**) or push [MENU](**C**) to exit the Direct input screen.

[Example]

To select the Memory channel 24:

➔ Touch [2], [4] then [ENT].

To select the Scan edge channel 1B:

➔ Touch [1], [0], [1] then [ENT].

To select the CALL2 channel on the 430 MHz band:

➔ Touch [1], [0], [9] then [ENT].

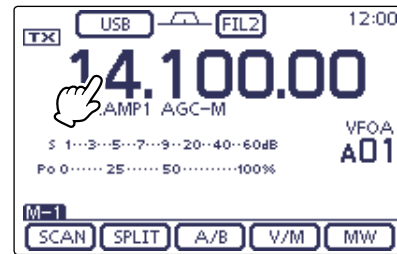

Touch the MHz digits

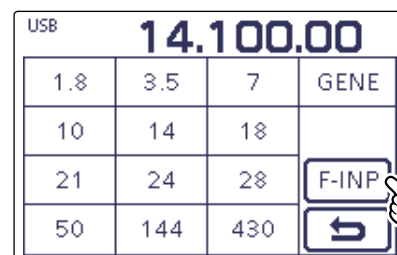

Touch [F-INP]

• **Direct input screen**

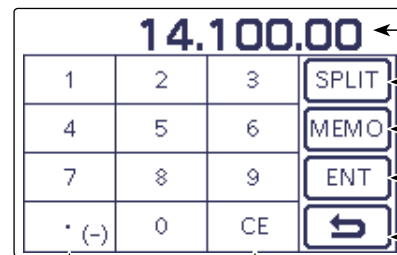

Shows the input digits
 Enter the Split offset
 Enter the Memory channel
 Enter the frequency
 Cancel edit
 Delete entering

Enter a “.” decimal point, or minus (-) input for Split offset

• **Scan edge channels and Call channels**

	Channel	Input	Channel	Input
Scan edge channels	1A	100	1B	101
	2A	102	2B	103
	3A	104	3B	105
Call channels	144 MHz CALL1	106	144 MHz CALL2	107
	430 MHz CALL1	108	430 MHz CALL2	109

The **L**, **R**, **C** or **D** in the instructions indicate the part of the controller.
L: Left side, **R**: Right side, **C**: Center bottom
D: Display (Touch screen)

Setting frequency (Continued)

◇ **Band edge warning beep**

You can hear a beep tone when you tune into or out of an amateur band's frequency range. A regular beep sounds when you tune into a range, and an lower tone error beep sounds when you tune out of a range.

- ① Push **SET**(**C**) to enter the Set mode.
- ② Touch the "Band Edge Beep" item of the "Function" Set mode.

Function > **Band Edge Beep**

- If the specified item is not displayed, touch [**▲**] or [**▼**](**D**) one or more times to select the page.

- ③ Touch the desired option to select the desired band edge warning beep setting, or to turn OFF the function.

- OFF: Band edge beep is OFF.
- ON (Default): When you tune into or out of the default amateur band's frequency range, a beep sounds.
- ON (User): When you tune into or out of a user programmed amateur band's frequency range, a beep sounds.
- ON (User) & TX Limit: When you tune into or out of a user programmed amateur band's frequency range, a beep sounds. Also transmission is inhibited outside the programmed range.

- If desired, touch the item for 1 second to open the Default set window, then select the "Default" to reset to the default setting.

- ④ Push **SET**(**C**) to exit the Set mode.

▨ If the "Beep Level" item is set to "0," the Band edge beep does not sound. The beep output level can be set in the "Beep Level" item of the "Function" Set mode. (p. 6-5)

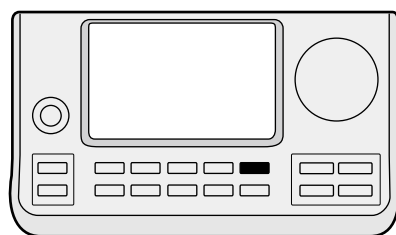

Push **SET**

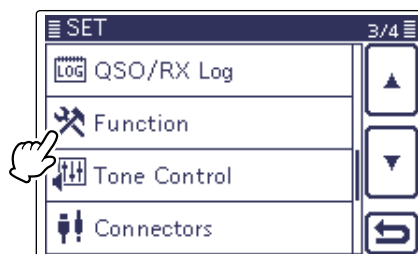

Touch "Function"

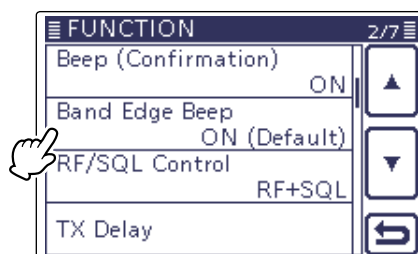

Touch "Band Edge Beep"

About the user band edge frequencies

When "ON (User)" or "ON (User) & TX Limit" is selected in the "Band Edge Beep" item, a total of 30 band edge frequencies can be programmed in the "User Band Edge" item. See the next page for details.

If "OFF" or "ON (Default)" is selected, the "User Band Edge" item does not appear in the "Function" Set mode.

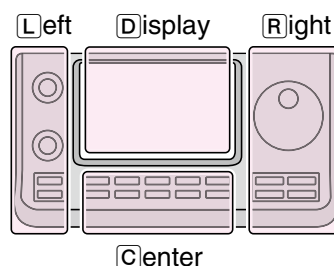

The **L**, **R**, **C** or **D** in the instructions indicate the part of the controller.

- L**: Left side
- R**: Right side
- C**: Center bottom
- D**: Display (Touch screen)

Setting frequency (Continued)

◇ Programming the user band edge

When “ON (User)” or “ON (User) & TX Limit” is selected in the “Band Edge Beep” item, the “User Band Edge” item appears in the “Function” Set mode.

A total of 30 band edge frequencies can be programmed in the “User Band Edge” item.

NOTE:

- All frequency ranges are set to default, so you should delete or change them to add the desired band edge frequency.
- Program each channel from left to right and each frequency must be higher than the preceding frequency.
- The frequency that is duplicated, or out of a transmit frequency range, cannot be programmed.

- ① Push **SET**(C) to enter the Set mode.
- ② Touch the “Band Edge Beep” item of the “Function” Set mode.
Function > **Band Edge Beep**
• If the specified item is not displayed, touch **[▲]** or **[▼]**(D) one or more times to select the page.
- ③ Touch the “ON (USER)” or “ON (User) & TX Limit” option.
- ④ Touch the “User Band Edge” item of the “Function” Set mode.
Function > **User Band Edge**
- ⑤ Follow the instructions in the next topics to delete, insert, edit, change or reset Band edges.
- ⑥ After you have finished, push **SET**(C) to exit the Set mode.

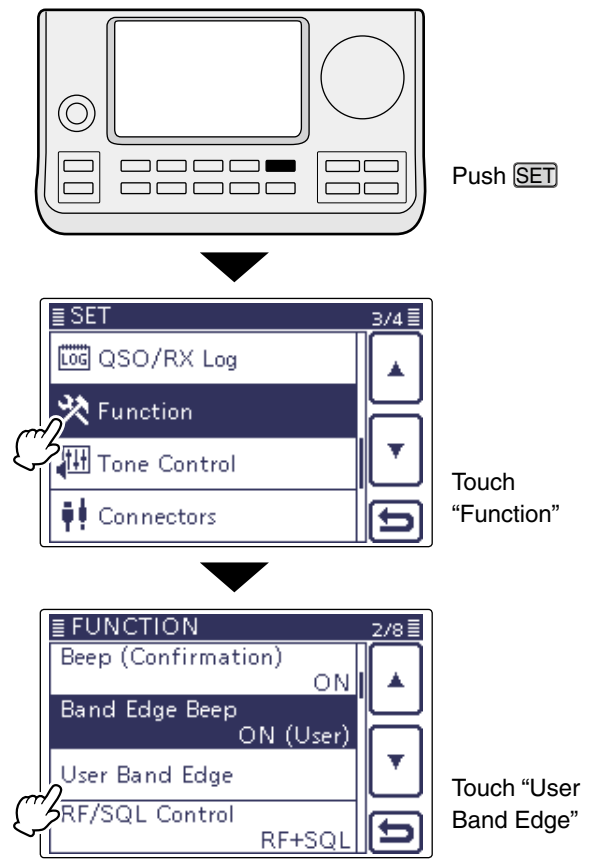

• Deleting a Band edge

- ① Enter the “User Band Edge” screen.
SET(C) > Function > **User Band Edge**
- ② Touch for 1 second the Band edge to be deleted.
• If the specified band edge is not displayed, touch **[▲]** or **[▼]**(D) one or more times to select the page.
- ③ Touch “Delete.”
• The selected Band edge has been deleted, and then returns to the User Band Edge screen.
- ④ Touch **[>]**(D) or push **MENU**(C) to return to the “Function” Set screen.

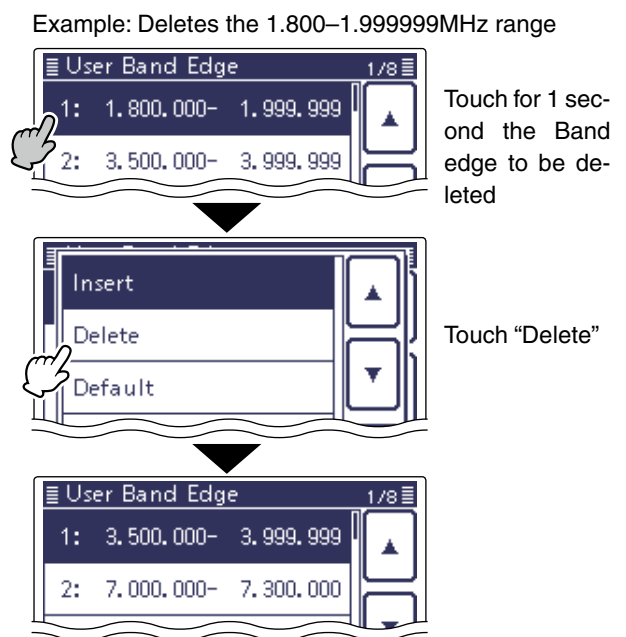

The **L**, **R**, **C** or **D** in the instructions indicate the part of the controller.
L: Left side, **R**: Right side, **C**: Center bottom
D: Display (Touch screen)

Setting frequency (Continued)

◇ Programming the user band edge (Continued)

• Inserting a Band edge

- ① Enter the "User Band Edge" screen.
 [SET](C) > Function > **User Band Edge**
- ② Touch for 1 second the Band edge that you want to insert a new Band edge above it.
 - If the desired Band edge is not displayed, touch [▲] or [▼](D) one or more times to select the page.
- ③ Touch "Insert."
 - The frequency entry screen is displayed.
- ④ Touch desired numbers to edit the lower edge frequency, and then touch [ENT](D).
 - The cursor moves to the upper frequency entry, and a same frequency as lower frequency is automatically input.
 - Touch [◀ ▶](D) to toggle the lower or upper frequency entry.
 - Touch [←] or [→](D) to move the cursor left or right.
 - Before entering the frequencies, touch [↵](D) or push [MENU](C) to insert a blank field.
- ⑤ Touch desired numbers to edit the upper edge frequency, and then touch [ENT](D).
- ⑥ Touch [↵](D) or push [MENU](C) to return to the "Function" Set screen.

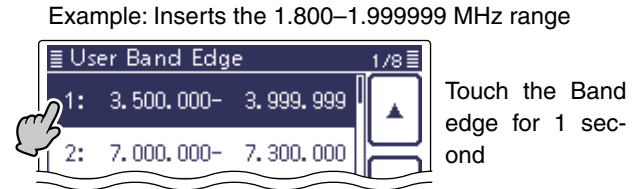

• The frequency entry screen

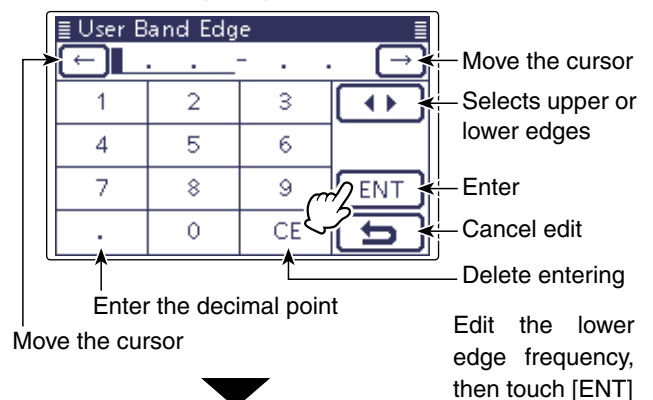

• Editing a new Band edge

- ① Enter the "User Band Edge" screen.
 [SET](C) > Function > **User Band Edge**
- ② Touch a blanked field.
 - If the desired blank field is not displayed, touch [▲] or [▼](D) one or more times to select the page.
 - The frequency entry screen is displayed.
- ③ Touch desired numbers to edit the lower edge frequency, and then touch [ENT](D).
 - The cursor moves to the upper frequency entry, and a same frequency as lower frequency is automatically input.
 - Touch [◀ ▶](D) to toggle the lower or upper frequency entry.
 - Touch [←] or [→](D) to move the cursor left or right.
- ④ Touch desired numbers to edit the upper edge frequency, and then touch [ENT](D).
- ⑤ Touch [↵](D) or push [MENU](C) to return to the "Function" Set screen.

Same frequency as lower frequency is automatically input

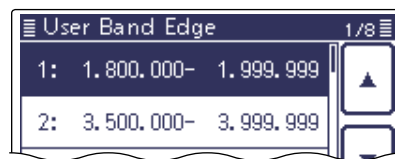
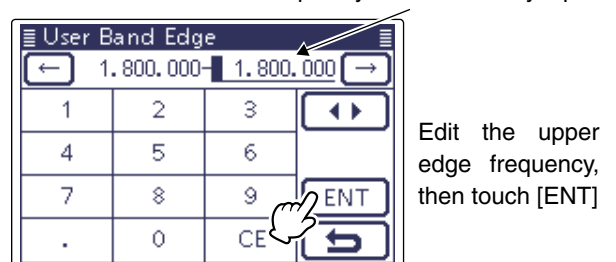

The **L**, **R**, **C** or **D** in the instructions indicate the part of the controller.
L: Left side, **R**: Right side, **C**: Center bottom
D: Display (Touch screen)

Setting frequency (Continued)

◇ Programming the user band edge (Continued)

• **Changing the Band edge frequencies**

- ① Enter the "User Band Edge" screen.
 [SET](C) > Function > **User Band Edge**
- ② Touch the Band edge to be changed.
 - If the desired Band edge is not displayed, touch [▲] or [▼](D) one or more times to select the page.
 - The frequency entry screen is displayed.
- ③ Touch desired numbers to edit the lower edge frequency, and then touch [ENT](D).
 - The cursor moves to the upper frequency entry.
 - Touch [◀▶](D) to toggle the lower or upper frequency entry.
 - Touch [←] or [→](D) to move the cursor left or right.
- ④ Touch desired numbers to edit the upper edge frequency, and then touch [ENT](D).
- ⑤ Touch [↵](D) or push [MENU](C) to return to the "Function" Set screen.

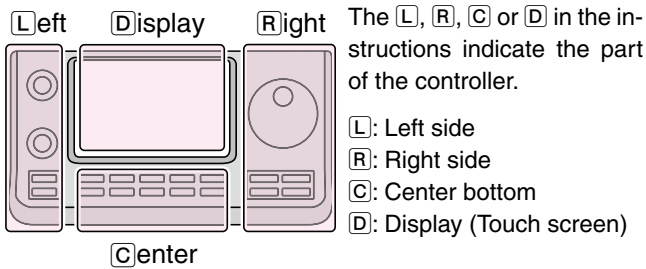

Example: Change the 7.000–7.300000 MHz range



• The frequency entry screen

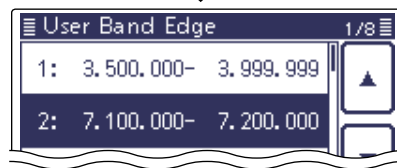
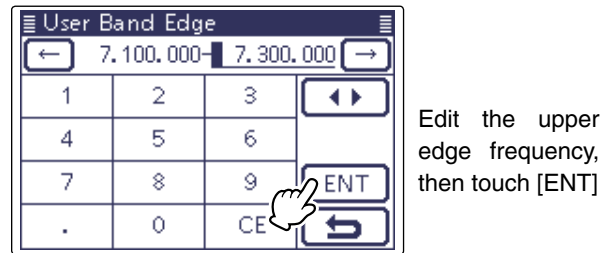
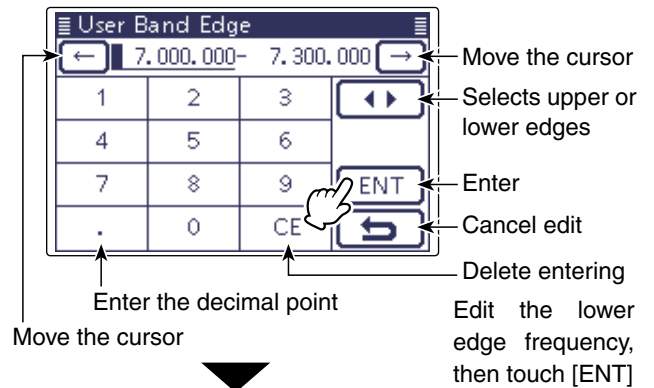

• **Resetting the Band edges**

- ① Enter the "User Band Edge" screen.
 [SET](C) > Function > **User Band Edge**
- ② Touch any band edges for 1 second.
- ③ Touch "Default."
 - "Initialize Edges?" is displayed.
- ④ Touch [YES](D).
 - Resets all band edge frequencies to default settings.
 - If desired, touch "NO" to cancel resetting.
- ⑤ Touch [↵](D) or push [MENU](C) to return to the "Function" Set screen.

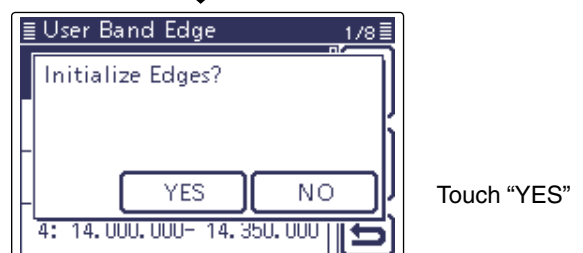

Selecting the Operating mode

The usable operating modes in the IC-7100 are listed to the right below.

You can select the desired operating mode by touching the mode key on the Mode selection screen.

NOTE:

In the AM mode, you can transmit on only the HF, 50/70* MHz frequency bands.

* 70 MHz band transmission is available, depending on the transceiver version.

- ① Touch the Mode icon to enter the Mode selection screen.
- ② Touch an operating mode, "SSB," "CW," "RTTY," "AM," "FM," "WFM" or "DV."
 - Touch the Operating mode to select the operating mode as shown in the 'Operating mode selection list.'
 - After touching, the display exits the Operating mode selection screen and returns to the previous screen.
 - While in the SSB, AM or FM mode "DATA" appears on the Mode selection screen. Touch "DATA" to select the SSB data, AM data or FM data modes.
 - If desired, touch [↩] (D) or push [MENU] (C) to exit the Mode selection screen.

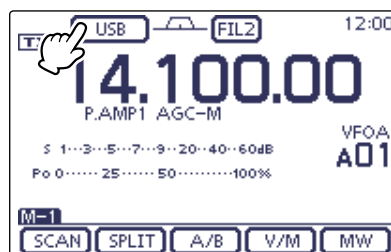

Touch the Mode icon



• Mode selection screen

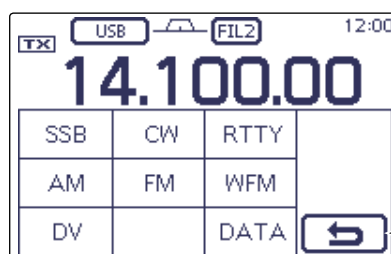

Cancel

• **Selecting the SSB mode**

- When operating above 10 MHz, USB is selected first; when operating below 10 MHz, LSB is selected first.
- In the SSB mode, touch "SSB" again to toggle between the LSB and USB modes.

• **Selecting the CW/CW-R modes**

- The CW reverse mode may reduce the interfering tone when it is near a desired signal.
- In the CW mode, touch "CW" again to toggle between the CW and CW-R modes.

• **Selecting the RTTY/RTTY-R modes**

- In the RTTY mode, touch "RTTY" again to toggle between the RTTY and RTTY-R modes.

• **Selecting the DV mode (including DR mode)***

- DV mode (digital voice + low-speed data communication) allows you to exchange text messages and call signs, and transmit position data with a third-party GPS receiver.
- The DV mode is automatically selected when the DR mode is ON.

• **Selecting the Data mode**

You can mute the microphone signals when the data mode is selected, depending on the "DATA MOD" option in the "Connectors" Set mode (p. 6-8).

[SET] (C) > Connectors > **DATA MOD**

• Operating mode selection list

Mode selection	Operating mode	
SSB	LSB	USB
CW	CW	CW-R
RTTY	RTTY	RTTY-R
AM	AM*	
FM	FM	
WFM	WFM (Only RX)	
DV	DV	
DATA	LSB	LSB data
	USB	USB data
	AM	AM data
	FM	FM data

* On the 144 MHz or 430 MHz bands, only the RX operation is available in the AM mode.

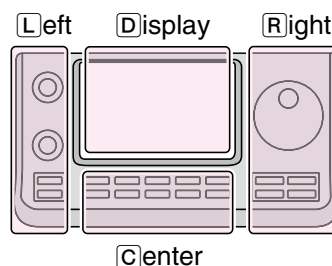

The [L], [R], [C] or [D] in the instructions indicate the part of the controller.

- [L]: Left side
- [R]: Right side
- [C]: Center bottom
- [D]: Display (Touch screen)

Selecting the Audio volume

➔ Rotate [AF] (L) control clockwise to increase the audio output level, counterclockwise to decrease it.

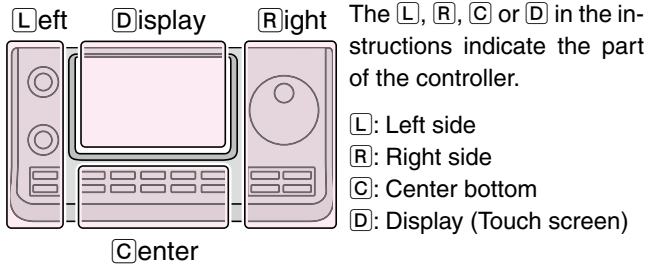
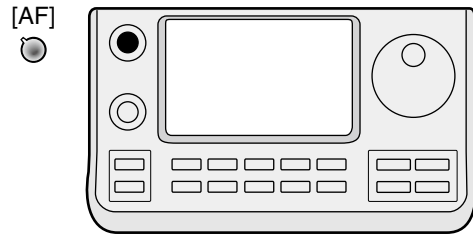
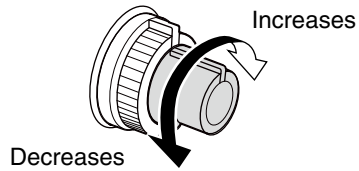

Scquelch and receive (RF) sensitivity

Adjusts the RF gain and squelch threshold level. The squelch removes noise output to the speaker when no signal is received (closed squelch).

- The squelch is particularly effective for AM and FM, but also works in other modes.
- The 12 to 1 o'clock position is recommended for the most effective use of the [RF/SQL]Ⓞ(L) control.
- The [RF/SQL]Ⓞ(L) control operates as only an RF gain control (Squelch is fixed open), or a squelch control (RF gain is fixed at maximum sensitivity) depending on the "RF/SQL Control" option in the "Function" Set mode. (p. 6-5)

[SET] > Function > RF/SQL Control

SET MODE SETTING	OPERATING MODE	[RF/SQL] OPERATION
AUTO	AM/FM/WFM/DV	Operates as only a squelch control. • RF gain is fixed at maximum sensitivity.
	SSB/CW/RTTY	Operates as only an RF gain control. • Squelch is fixed open.
SQL	ALL	Operates as only a squelch control. • RF gain is fixed at maximum sensitivity.
RF+SQL (default)	FM/DV	Operates as an RF gain control, and a noise squelch or S-meter squelch.
	SSB/CW/RTTY/AM	Operates as an RF gain control, and an S-meter squelch.

○ Adjusting RF gain (Receive sensitivity)

Normally, [RF/SQL]Ⓞ(L) is set to the 12 o'clock position.

Rotate [RF/SQL]Ⓞ(L) to the 11 o'clock position for maximum sensitivity.

- Rotating counterclockwise from the maximum position reduces sensitivity.
- The S-meter indicates receive sensitivity.

While rotating the RF gain control, a faint noise may be heard. This comes from the DSP unit and does not indicate an equipment malfunction.

○ Adjusting squelch (Removing non-signal noise)

Rotate [RF/SQL]Ⓞ(L) clockwise when no signal is received, until the noise just disappears.

- The TX/RX LED light goes out.
- Rotating [RF/SQL]Ⓞ(L) past the threshold point activates the S-meter squelch— this allows you to set a minimum signal level needed to open the squelch.

The **L**, **R**, **C** or **D** in the instructions indicate the part of the controller.

L: Left side, **R**: Right side, **C**: Center bottom
D: Display (Touch screen)

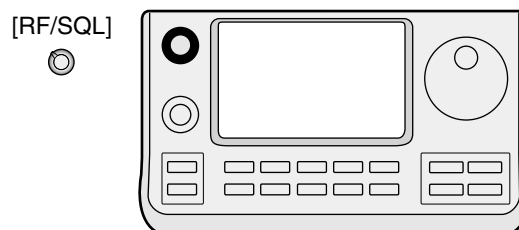

• When used as an RF gain/squelch control

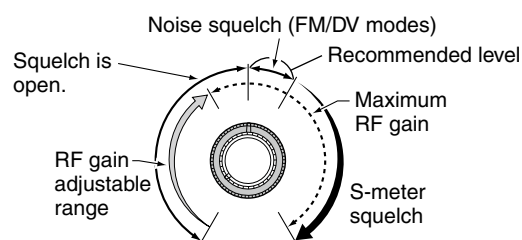

• When used as an RF gain control (Squelch is fixed open; SSB, CW, RTTY only)

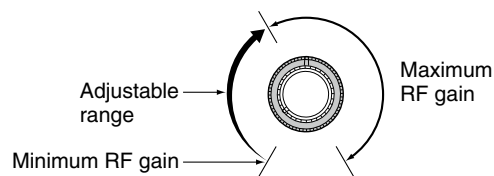

• When used as a squelch control (RF gain is fixed at maximum.)

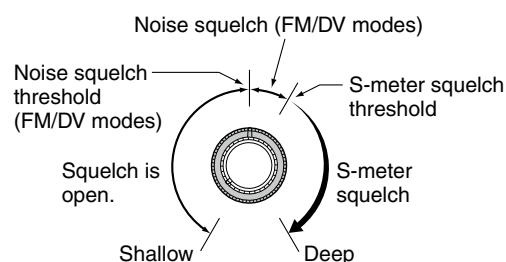

Voice synthesizer operation

The IC-7100 has a built-in voice synthesizer to announce the operating frequency, mode and S-meter level in a clear, electronically-generated voice, in English or Japanese.

First, select the desired parameters to be announced in the "Speech" Set mode. (p. 6-4)

Initial values for the voice synthesizer parameters

- RX Call Sign SPEECH: ON (Kerchunk)
- RX>CS SPEECH: ON
- S-Level SPEECH: ON
- MODE SPEECH: OFF
- SPEECH Language: English
- Alphabet: Normal
- SPEECH Speed: Fast
- SPEECH Level: 50%
- [SPEECH/LOCK] Switch: SPEECH/LOCK*

*See **NOTE** as described below.

➔ Push [SPEECH/LOCK] to announce the currently selected frequency, mode and S-meter level*.

* The S-meter level announcement can be turned OFF. (p. 6-4)

NOTE: If "SPEECH/LOCK" is not selected in the "[SPEECH/LOCK] Switch" item of the "Function" Set mode, you should hold down **SPEECH** (R) for 1 second to activate the voice synthesizer.

➔ Push a mode switch to announce the appropriate mode, when the "MODE SPEECH" item is set to "ON" in the "SPEECH" Set mode. (p. 6-4)

SET(C) > SPEECH > **MODE SPEECH**

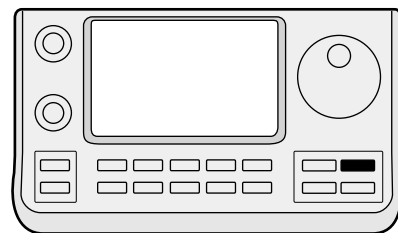
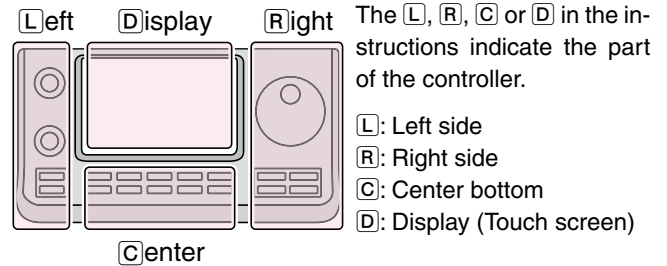

SPEECH

Voice synthesizer operation (Continued)

◇ Turning OFF the S-meter announcement

The S-meter announcement can be turned OFF.

- ① Push **SET**(C) to enter the Set mode.
- ② Touch the "S-Level SPEECH" item of the "SPEECH" Set mode.
 SPEECH > **S-Level SPEECH**
 - If the specified item is not displayed, touch **[▲]** or **[▼]**(D) one or more times to select the page.
- ③ Touch the option to turn OFF the function.
- ④ Push **SET**(C) to exit the Set mode.

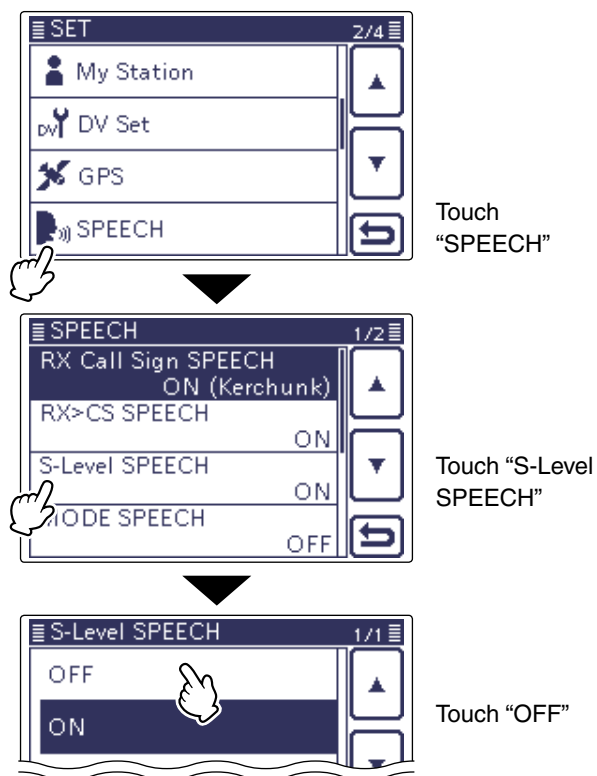

◇ Turning ON the MODE announcement

When this function is ON, the selected operating mode is verbally announced when a mode is selected.

- ① Push **SET**(C) to enter the Set mode.
- ② Touch the "MODE SPEECH" item of the "SPEECH" Set mode.
 SPEECH > **MODE SPEECH**
 - If the specified item is not displayed, touch **[▲]** or **[▼]**(D) one or more times to select the page.
- ③ Touch the option to turn ON the function.
- ④ Push **SET**(C) to exit the Set mode.

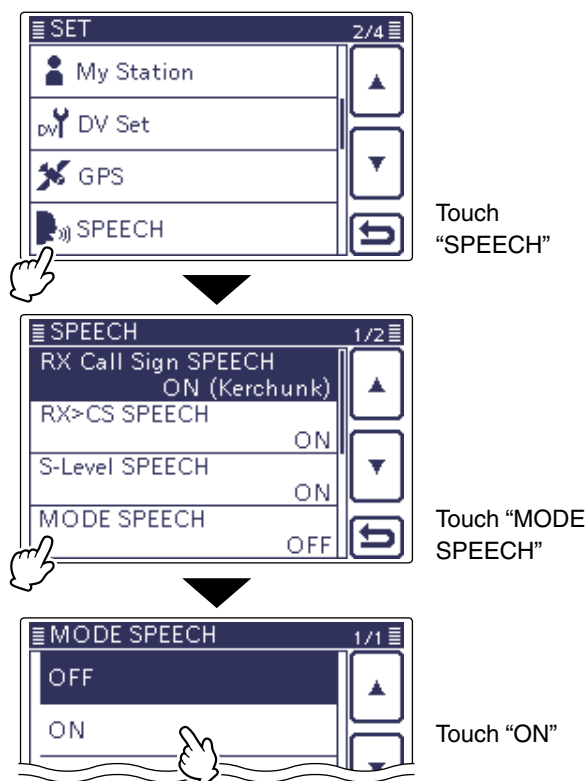

Meter display selection

The transmit meter can be toggled between four functions for your convenience.

- Touch the Meter one or more times to select the TX meter function, RF power meter, SWR meter, ALC meter or COMP meter.
 - Po : Displays the relative RF output power.
 - SWR : Displays the SWR of the antenna at the frequency.
 - ALC : Displays the ALC level. When the meter movement shows the input signal level exceeds the allowable level, the ALC limits the RF power. In such cases, decrease the microphone gain level.
 - COMP : Displays the compression level when the speech compressor is in use.
- Touch the Meter for 1 second to select the Multi-function meter.
 - Touch the Multi-function meter to cancel the meter.

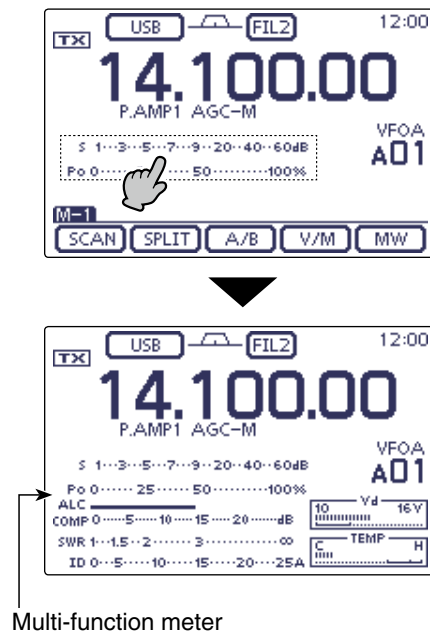
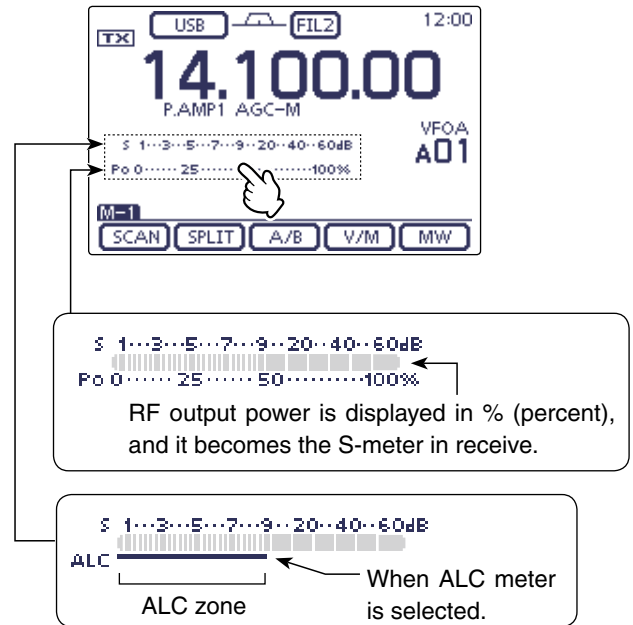

Basic transmit operation

Before transmitting, monitor the operating frequency to make sure transmitting won't cause interference to other stations on the same frequency. It's good amateur practice to listen first, and then, even if nothing is heard, ask "Is the frequency in use?" once or twice, before you begin operating on that frequency.

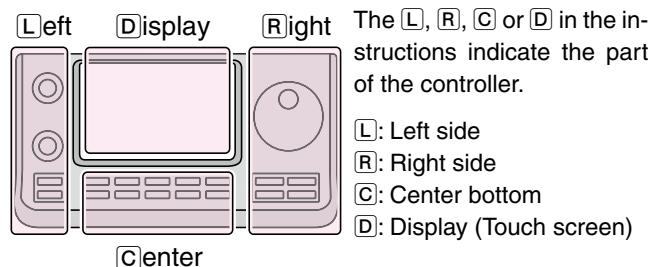

◇ Transmitting

CAUTION: Transmitting without an antenna may damage the transceiver.

In the AM mode, you can transmit on only the HF, 50/70* MHz frequency bands.

* 70 MHz band transmission is available, depending on the transceiver version.

- ① Push [PTT] on the microphone to transmit (or external transmit switch).
 - The TX/RX LED lights red.
- ② Release [PTT] again to receive (or external transmit switch).

✓ Adjusting the transmit output power

- ① Push [MIC/RF PWR](C) to open the MIC gain/RF power adjustment display.
- ② Rotate [BANK]Ⓞ(L) to adjust the RF power.
- ③ Push [MENU](C) to close the display.

Frequency band	RF output power range
HF/50 MHz	2 to 100 W (AM: 1 to 30 W)
70 MHz*	2 to 50 W (AM: 1 to 15 W)
144 MHz	2 to 50 W
430 MHz	2 to 35 W

* 70 MHz can be used, depending on transceiver versions.

NOTE: The RF output power settings are independently memorized in the HF, 50, 70, 144 and 430 MHz bands.

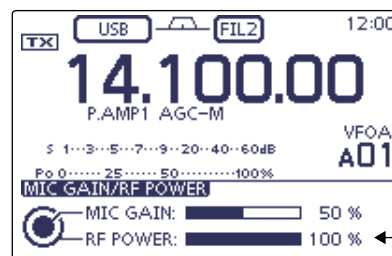
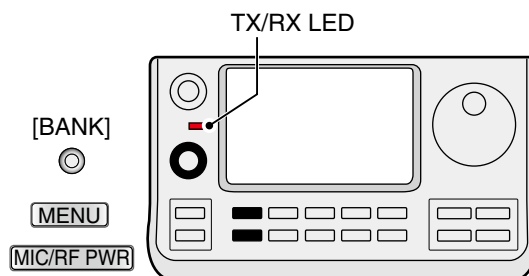

Output power adjustment

Basic transmit operation (Continued)

◇ **Microphone gain adjustment**
(Mode: SSB/AM/FM/DV)

- ① Push [MIC/RF PWR] (C) to open the MIC gain/RF power adjustment display.
- ② Push [PTT] to transmit.
 - Speak into the microphone at your normal voice level.
- ③ Rotate [M-CH] (L) to adjust the MIC gain.
 - /// When the MIC gain is adjusted too high, your transmitted voice may be distorted.
- ④ Release [PTT] to receive.
- ⑤ Push [MENU] (C) to close the display.

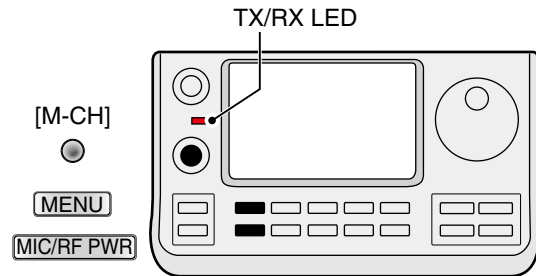

○ **In the SSB mode:**

Touch the TX meter to select the ALC meter. Then, while speaking into the microphone, rotate [M-CH] (L) so that the ALC meter reading stays within the ALC zone.

○ **In the AM, FM and DV modes:**

While speaking into the microphone, rotate [M-CH] (L) with another station listening to your voice for clarity.

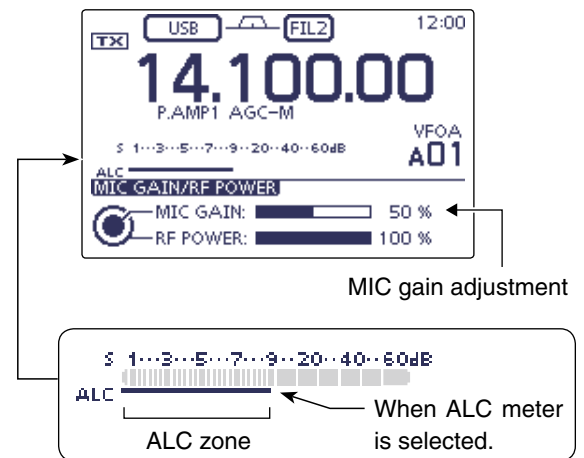

“MY” (Your own call sign) programming	4-2
D-STAR Introduction	4-5
About the DR (D-STAR Repeater) mode	4-5
Communication Form in the DR mode	4-6

Section 1 PANEL DESCRIPTION

Section 2 INSTALLATION AND CONNECTIONS

Section 3 BASIC OPERATION

Section 4 D-STAR INTRODUCTION

Section 5 D-STAR OPERATION <BASIC>

Section 6 SET MODE

Section 7 INFORMATION

IMPORTANT!

- The repeater list described in this manual may differ from your transceiver's preloaded contents.
- Although Japanese repeaters are used in the setting examples, the Japanese repeater node (port) letters are different from those in other countries.

Be sure to add a repeater node letter as the 8th digit in the call sign field after a repeater call sign according to the repeater frequency band shown below.

1200 MHz: A (B in Japan)

430 MHz: B (A in Japan)

144 MHz: C (no D-STAR repeaters in Japan)

'FM' means 'Full Manual.'

'sec. * *' means section number.

So when '(FM sec. * *)' is described on this manual, see the PDF type Full Manual's section number for your reference.

“MY” (Your own call sign) programming

Before starting D-STAR, the following steps are needed.

IMPORTANT! **STEP 1** Entering your call sign (MY) into the transceiver. → **STEP 2** Registering your call sign (MY) to a gateway repeater. → You have completed the steps!!

You can store up to 6 “MY” call signs.

Example: Enter “JA3YUA” as your own call sign into the MY call sign memory [MY1].

1. Display the My Call Sign Edit screen

- ① Push **SET**(C) to enter the Set mode.
- ② Touch the “MY Call Sign” item of the “My Station” Set mode.
 My Station > **MY Call Sign**
 - If the specified item is not displayed, touch [▲] or [▼](D) one or more times to select the page.
- ③ Touch the desired call sign memory for 1 second.
 (Example: 1:)
- ④ Touch the “Edit” item.
 • The “MY CALL SIGN (MY*)” screen appears.
 The memory number, selected in the step ③, is displayed.
 (Example: MY1)

The **L**, **R**, **C** or **D** in the instructions indicate the part of the controller.

L: Left side, **R**: Right side, **C**: Center bottom
D: Display (Touch screen)

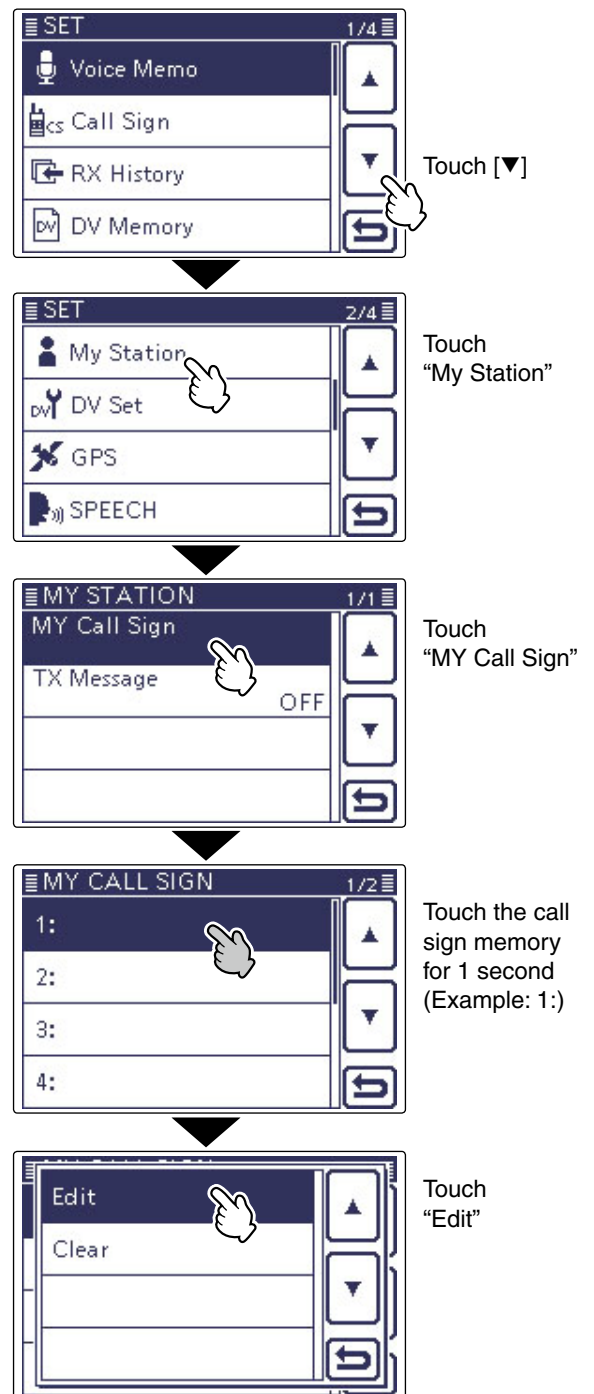

Continued on the next page

“MY” (Your own call sign) programming (Continued)

2. Enter the Call Sign

- ⑤ Touch the desired block one or more times to select the desired character.
 - (Example: J)
 - A to Z, 0 to 9 and / are selectable.
 - Touch “AB↔12” to toggle between the Alphabet input and the Number input mode.
 - Touch [CLR](D) to delete the selected character, symbol or number.
 - Touch “_” to input a space.
- ⑥ Touch [←](D) to move the cursor backwards, or touch [→](D) to move the cursor forwards.
- ⑦ Repeat steps ⑤ and ⑥ to enter your own call sign of up to 8 characters, including spaces.
 - (Example: First J, then A, then 3, then Y, then U, then A)
- ⑧ Touch [ENT](D) to return to the “MY CALL SIGN” screen.

Call sign edit screen

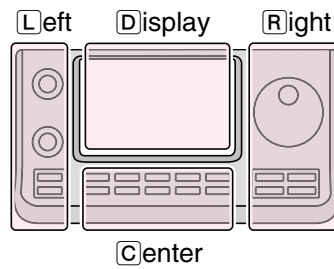
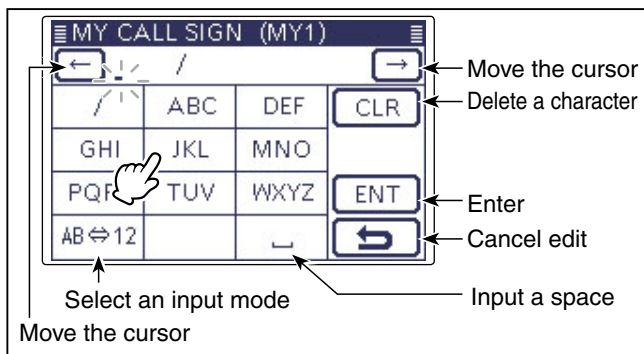

The L, R, C or D in the instructions indicate the part of the controller.

Enter “JA3YUA” into ‘MY1.’

- ① Touch “JKL” to enter ‘J.’
- ② Touch “ABC” to enter ‘A.’
- ③ Touch “AB↔12.”
- Number input mode is selected.
- ④ Touch “3” to enter ‘3.’
- ⑤ Touch “AB↔12.”
- Alphabet input mode is selected.
- ⑥ Touch “WXYZ” three times to enter ‘Y.’
- ⑦ Touch “TUV” two times to enter ‘U.’
- ⑧ Touch “ABC” to enter ‘A.’
- ⑨ Touch [ENT]

Continued on the next page

“MY” (Your own call sign) programming

2. Enter the Call Sign (Continued)

- ⑨ Touch the entered call sign to set the call sign to be used.
- ⑩ Push **SET**(C) to exit the Set mode.

✓ Convenient!

If necessary, enter a note of up to 4 characters, such as the model of the transceiver, name, area name, and so on, after your call sign.

- ① Touch **[→]**(D) one or more times until the cursor moves to the right of the “/”.



- ② Repeat steps ⑤ and ⑥ on the page 4-3 to enter a desired 4 character note.
(Example: 7100)

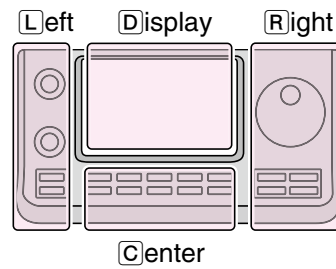
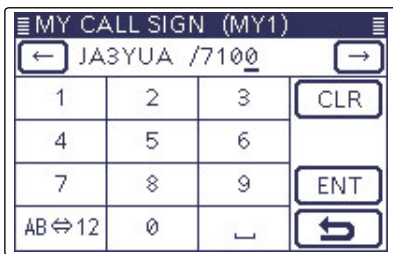

The **L**, **R**, **C** or **D** in the instructions indicate the part of the controller.

- L**: Left side
- R**: Right side
- C**: Center bottom
- D**: Display (Touch screen)

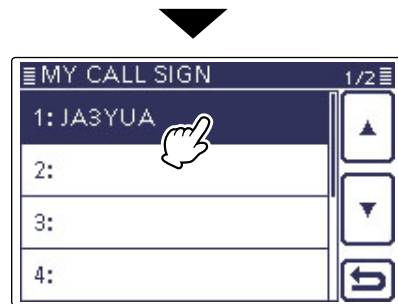

Touch the call sign
(Example: 1:JA3YUA)

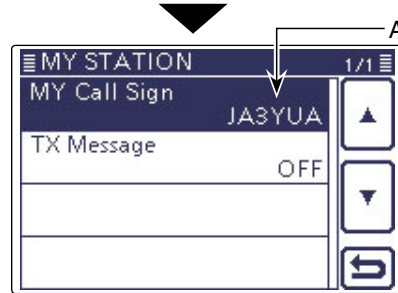

Appears

Push **SET**

✓ Important!

To use a repeater gateway, you must register your call sign with a gateway repeater, usually one near your home location.

If needed, ask the gateway repeater administrator for call sign registration instructions.

D-STAR Introduction

- In the original D-STAR (Digital Smart Technologies for Amateur Radio) plan, JARL envisioned a system of repeaters grouped together into Zones.
- The D-STAR repeater enables you to call a HAM station on another repeater through the internet.
- The transceiver can be operated in the digital voice mode, including low-speed data operation, for both transmit and receive.

About the DR (D-STAR Repeater) mode

The DR (D-STAR Repeater) mode is one mode you can use for D-STAR repeater operation. In this mode, you can select a preprogrammed repeater or frequency in "FROM" (the access repeater or simplex), and UR call sign in "TO" (destination), as shown to the right.

NOTE: If the repeater, set to "FROM" (Access Repeater) has no Gateway call sign, you cannot make a gateway call.

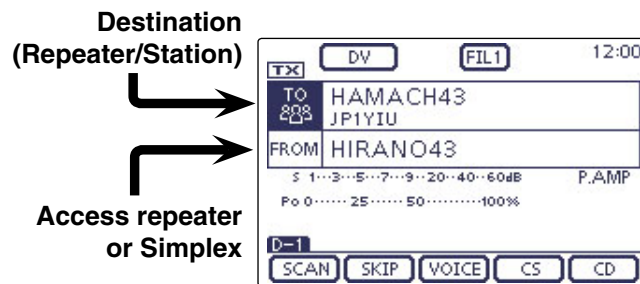

In the DR mode

Communication Form in the DR mode

In the DR mode, the transceiver has three communication forms, as shown below.

- Local area call: To call through your local area (access) repeater.
- Gateway call: To call through your local area (access) repeater, repeater gateway and the internet to your destination repeater or individual station's last used repeater, using call sign routing.
- Simplex call: To call another station not using a repeater.

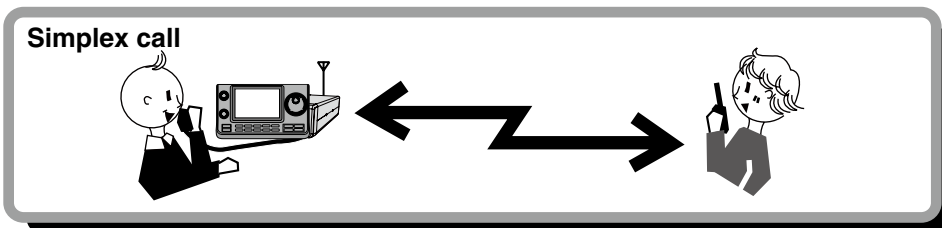
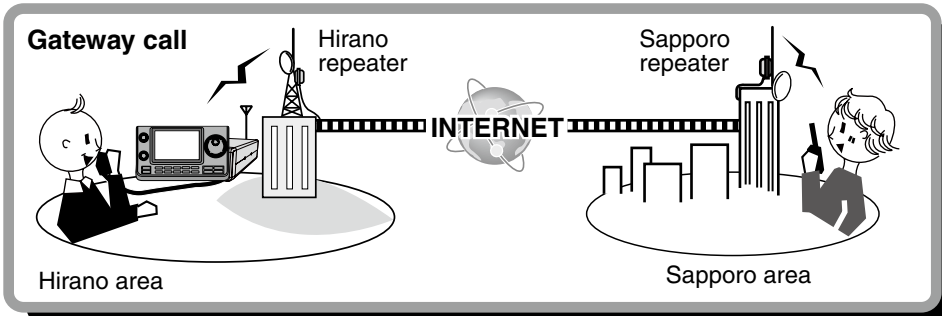
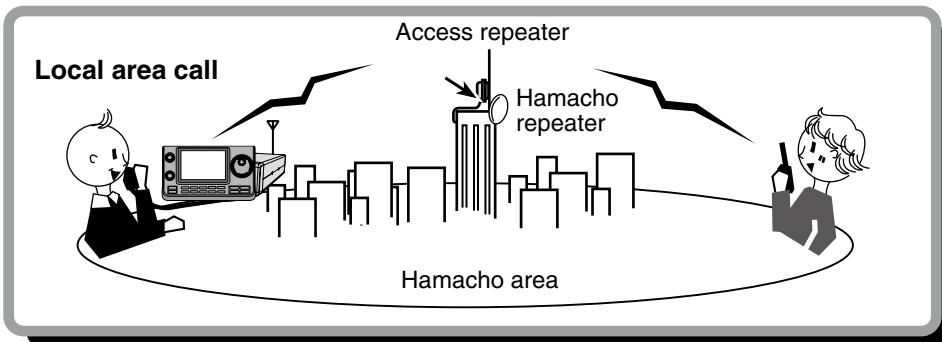

NOTE:

- Programming the repeater list is required for DR mode operation. (FM sec. 9)
- Before operating in the DV mode, be sure to check whether the access repeater is busy, or not. If the repeater is busy, wait until it is clear, or ask for a “break” using a method acceptable to your local procedures.
- The transceiver has a Time-Out Timer function for digital repeater operation. The timer limits a continuous transmission to approximately 10 minutes. Warning beeps will sound approximately 30 seconds before time-out and then again immediately before time-out.

D-STAR Operating procedures	5-2
◇ Making a Local area call.....	5-2
◇ Making a Gateway call	5-3
About “UR?” and “RPT?” error messages	5-5
◇ Shows “UR?”	5-5
◇ Shows “RPT?” or “RX”.....	5-5
◇ Shows “L”.....	5-5
Capturing a call sign	5-6
“FROM” (Access repeater) setting	5-7
◇ Using the preloaded repeater list	5-8
◇ Using the DR mode scan	5-9
◇ Using the Repeater Search function	5-10
◇ Using the TX History	5-12
“TO” (Destination) setting	5-13
◇ Using the “Local CQ” (Local Area call)	5-14
◇ Using the “Gateway CQ” (Gateway call).....	5-15
◇ Using the “Your Call Sign”	5-16
◇ Using the RX History	5-17
◇ Using the TX History	5-18
◇ Directly inputting (UR)	5-19
◇ Directly inputting (RPT)	5-20

Section 1 PANEL DESCRIPTION

Section 2 INSTALLATION AND CONNECTIONS

Section 3 BASIC OPERATION

Section 4 D-STAR INTRODUCTION

Section 5 D-STAR OPERATION <BASIC>

Section 6 SET MODE

Section 7 INFORMATION

IMPORTANT!

- The repeater list described in this manual may differ from your transceiver's preloaded contents.
- Although Japanese repeaters are used in the setting examples, the Japanese repeater node (port) letters are different from those in other countries.

Be sure to add a repeater node letter as the 8th digit in the call sign field after a repeater call sign according to the repeater frequency band shown below.

1200 MHz: A (B in Japan)

430 MHz: B (A in Japan)

144 MHz: C (no D-STAR repeaters in Japan)

'FM' means 'Full Manual.'

'sec. * *' means section number.

So when '(FM sec. * *)' is described on this manual, see the PDF type Full Manual's section number for your reference.

D-STAR Operating procedures

This section describes the basic D-Star procedures.

- When it is the first time to operate D-STAR, check whether or not you can access your local area repeater (Access repeater), and if your signal is successfully sent to a destination repeater.
- If your call sign (MY) has not been set, or your call sign has not been registered on a D-STAR repeater, see pages 4-2 and 4-4.

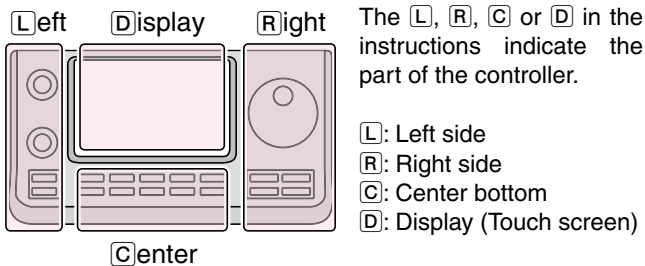

◇ Making a Local area call

1. Set "FROM" (Access repeater)

- ① Push **DR**(C) to select the DR mode.
- ② Check whether or not "FROM" is selected.
 - If "FROM" is not selected, touch the "FROM" field.
- ③ Touch the "FROM" field.
 - The "FROM SELECT" screen appears.
- ④ Touch "Repeater List."
- ⑤ Touch the repeater group where your access repeater is listed.
 - Example: "11: Japan"
- ⑥ Touch your access repeater.
 - Example: "Hirano"
 - The transceiver returns to the DR mode screen, and the selected repeater is set in "FROM."

2. Set "TO" (Destination)

- ⑦ Check whether or not "TO" is selected.
 - If "TO" is not selected, touch the "TO" field.
- ⑧ Touch the "TO" field.
 - The "TO SELECT" screen appears.
- ⑨ Touch "Local CQ."
- The transceiver returns to the DR mode screen, and "CQCQCQ" is set in "TO."

3. Hold down [PTT] to transmit

- While holding down [PTT], the TX/RX indicator lights red.

See page 5-5 to check whether you can access the repeater.

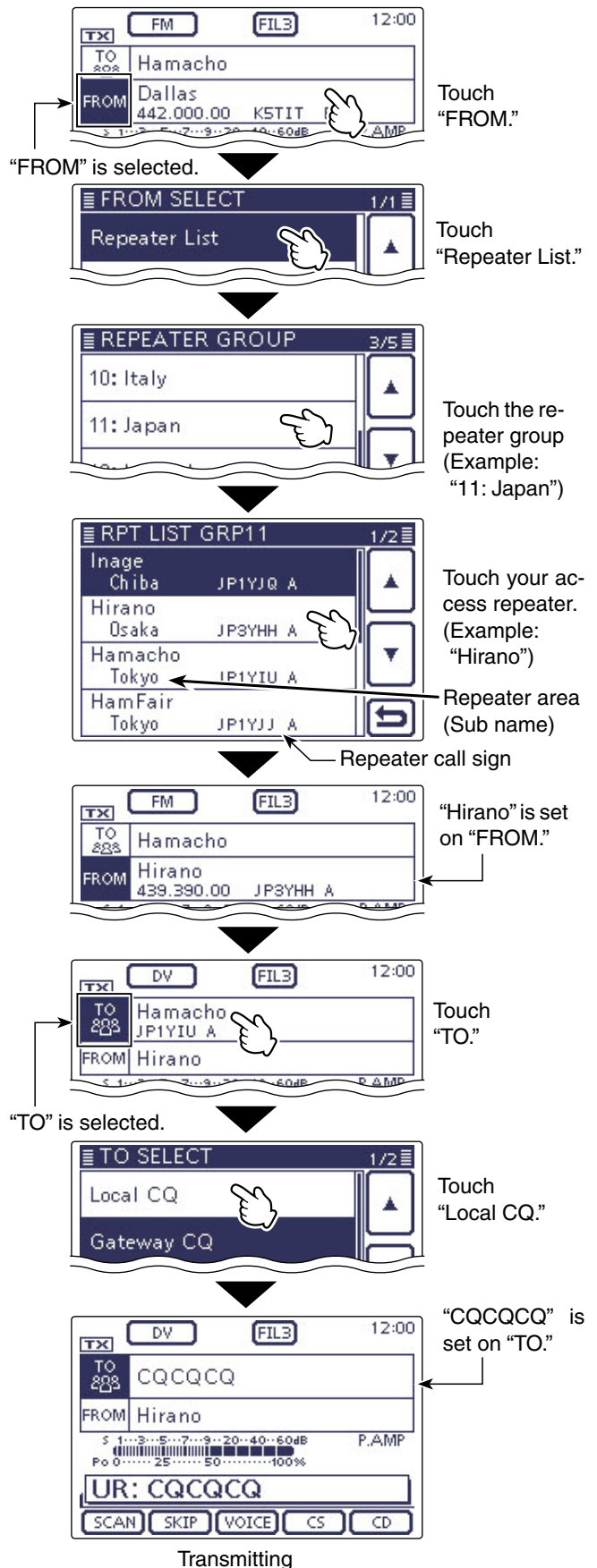

/// The repeater list, described in this manual, may differ from your transceiver's preloaded list.

D-STAR Operating procedures (Continued)

◇ Making a Gateway call

1. Set "FROM" (Access repeater)

- ① Push **[DR]**(**C**) to select the DR mode.
- ② Check whether or not "FROM" is selected.
 - If "FROM" is not selected, touch the "FROM" field.
- ③ Touch the "FROM" field.
 - The "FROM SELECT" screen appears.
- ④ Touch "Repeater List."
 - The "REPEATER GROUP" screen appears.
- ⑤ Touch the repeater group where your access repeater is listed.
 - Example: "11: Japan"
- ⑥ Touch your access repeater.
 - Example: "Hirano"
 - The transceiver returns to the DR mode screen, and the selected repeater is set in "FROM."

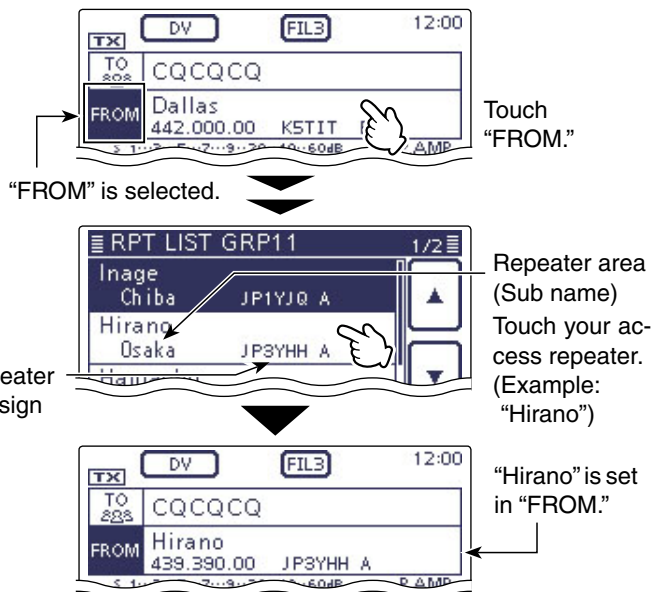

2. Set "TO" (Destination)

- ⑦ Check whether or not "TO" is selected.
 - If "TO" is not selected, touch the "TO" field.
- ⑧ Touch the "TO" field.
 - The "TO SELECT" screen appears.
- ⑨ Touch "Gateway CQ."
 - The "REPEATER GROUP" screen appears.
- ⑩ Touch the repeater group where your destination repeater is listed.
 - Example: "11: Japan"
- ⑪ Touch the destination repeater.
 - Example: "Hamacho"
 - The transceiver returns to the DR mode screen, and the selected repeater is set in "TO."

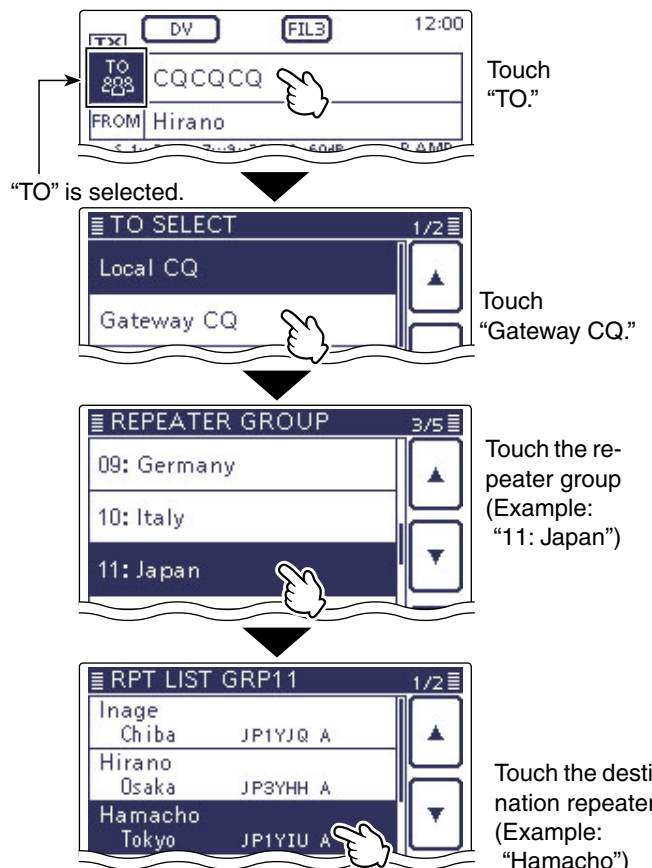

3. Hold down [PTT] to transmit

• While holding down [PTT], the TX/RX indicator lights red.

See page 5-5 to check whether you can access the repeater.

✓ Convenient!

The Gateway CQ call is used to call any repeater, but you can call a specific station by simply saying their call sign.

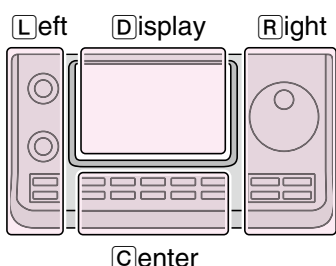

The **L**, **R**, **C** or **D** in the instructions indicate the part of the controller.

- L**: Left side
- R**: Right side
- C**: Center bottom
- D**: Display (Touch screen)

D-STAR Operating procedures (Continued)

< Communication example for a Gateway call >

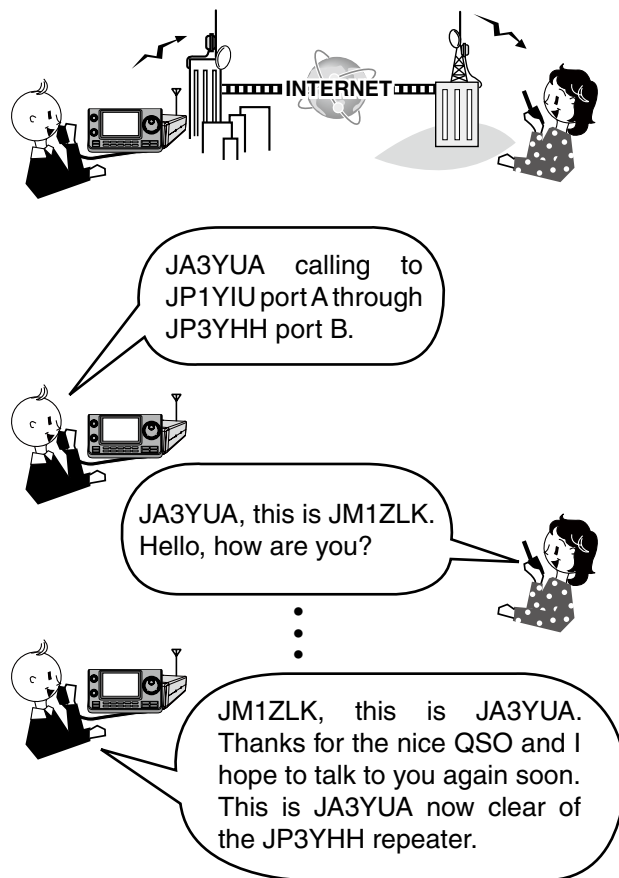

About “UR?” and “RPT?” error messages

The transceiver includes a status message in the signal received back from the access repeater, after transmitting.

◇ Shows “UR?”

The call was successfully sent, but no station’s signal was received within 3 seconds.

The called station may have missed your call, so after waiting for a while, try calling again.



This means that your local area call was correctly sent from the “Hirano” repeater.



This means that your gateway call was correctly sent from the “Hirano” repeater to the “Hamacho” repeater.

◇ Shows “RPT?” or “RX”

The destination repeater was not found, there is a programming error, or the destination repeater was busy.

When “RPT?” is displayed, after waiting for a while, try calling again, because in a gateway call, your signal is sent even if the destination repeater is busy.

NOTE: “RPT?” or “RX” is displayed when:

- The repeater call sign programming is in error.
- Your own call sign is not registered on a gateway repeater, or the registration contents is not matched.
- The destination call sign is not registered on a gateway repeater, or the registration contents is not matched.
- The destination repeater call sign is not registered on a gateway repeater, or the registration contents is not matched.
- The destination repeater cannot be accessed.
- A blank MY call sign memory is selected. (“RX” is displayed)



This means that your gateway call was sent from the “Hirano” repeater to the “Hamacho” repeater, but the “Hamacho” repeater was busy at the time.

◇ Shows “L”

While operating in the voice communication or low-speed data communication mode through the internet, some packets may be lost due to network error, or the caller’s signal is weak getting into the repeater. In such a case, “L” is displayed to indicate that Packet Loss has occurred.

When the transceiver receives corrupted data, and misidentifies it as Packet Loss, “L” is displayed, even if it is a Local area call.

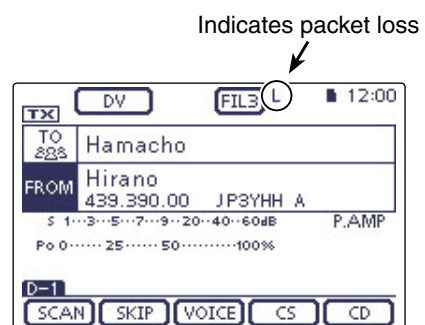

“L” blinks while packet loss is occurring.

Capturing a call sign

After you receive the repeater's signal, the calling station's call sign can be captured by holding down the Call Sign Capture key **AUTO TUNE (RX+CS)** (R). Then you can quickly and easily reply to the received call.

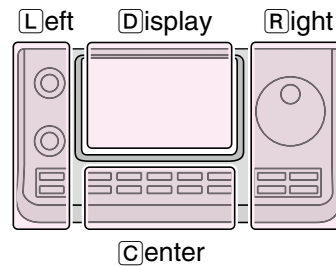

The L, R, C or D in the instructions indicate the part of the controller.

- L: Left side
- R: Right side
- C: Center bottom
- D: Display (Touch screen)

1. Set the received call sign to the destination

Hold down **AUTO TUNE (RX+CS)** (R) for 1 second.

- After releasing, beeps sound, and the station call sign is announced if the RX>CS Speech function is set to ON in the "SPEECH" Set mode.

SET (C) > SPEECH > **RX>CS SPEECH**

- If you want to select another call sign in the RX history, rotate [DIAL] while holding down **AUTO TUNE (RX+CS)** (R).

NOTE: When a received signal is weak, or during DR mode scanning, the call sign may not be received correctly. In that case, "-----" appears, an error beep sounds, and a quick reply call cannot be made.

2. Hold down [PTT] to transmit

- While holding down [PTT], the TX/RX indicator lights red.

NOTE: Push **AUTO TUNE (RX+CS)** (R) or **DR** (C), or touch "FROM" on the DR mode screen to cancel the Call Sign Capture mode, and return to the previous call sign setting.

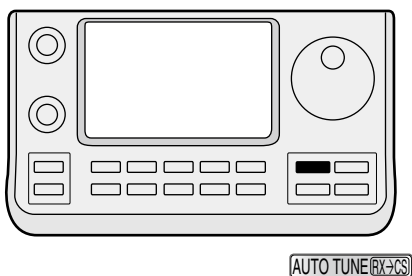

When receiving a call from "JG3LUK."

While receiving

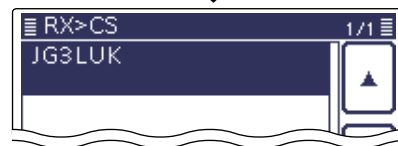

Beeps

While holding down **AUTO TUNE (RX+CS)** (R)

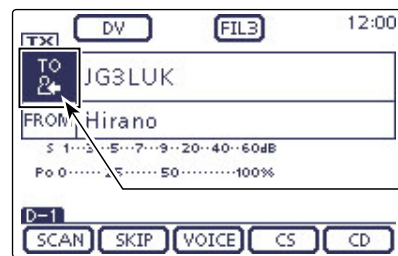

JG3LUK

Appears after selecting a call sign.

After releasing **AUTO TUNE (RX+CS)** (R)



Transmitting

“FROM” (Access repeater) setting

Your access repeater must be set to “FROM” when you transmit a call in the DR mode.

You have four ways to set the access repeater.

Click the title shown below to jump to the specified page.

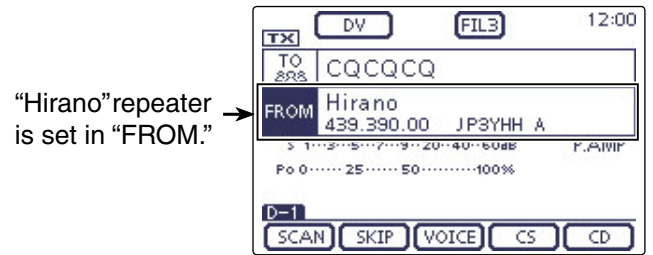

DR mode screen

Setting by the Dial

Select the preset repeater by rotating the Dial or [M-CH] (L) on the DR mode screen. Or, rotating [BANK] (L) selects the repeater group.

• When you know your access repeater

From the repeater list (p. 5-8)

When your access repeater is preloaded in your transceiver’s repeater list, you can select it by selecting the repeater area or name.

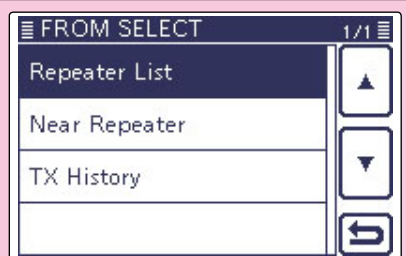

• When you don't know which repeater you can access.

Search for a repeater using the DR mode scan (p. 5-9)

Searches for DV signals from a repeater or a simplex frequency.



While DR mode scanning

Search for the nearest repeater (p. 5-10)

Searches for the nearest repeater by using your own and the repeater’s location.

The nearest repeaters in your transceiver’s repeater list are displayed as the available choices.

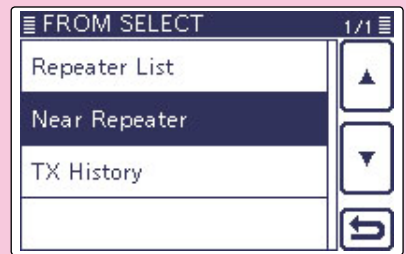

• When the “FROM” data is stored in the TX History.

Setting from the TX History (p. 5-12)

Select a repeater that you have accessed before, from the TX History record.

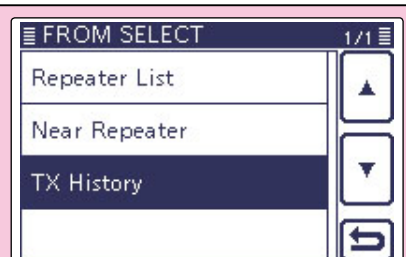

“FROM” (Access repeater) setting (Continued)

◇ Using the preloaded repeater list

When your access repeater is preloaded in your transceiver’s repeater list, you can select it from the repeater list.

By only selecting the repeater from the list, the call sign, frequency, duplex and offset frequency settings are automatically set for easy operation.

Example: Select the “Hirano” repeater in Japan from the repeater list.

- ① Push **DR**(**C**) to select the DR mode.
- ② Check whether or not “FROM” is selected.
 - If “FROM” is not selected, touch the “FROM” field.
- ③ Touch the “FROM” field.
 - The “FROM SELECT” screen appears.
- ④ Touch “Repeater List.”
 - The “REPEATER GROUP” screen appears.
- ⑤ Touch the repeater group where your access repeater is listed. (Example: “11: Japan”)
- ⑥ Touch your access repeater to select the repeater area or name. (Example: “Hirano”)
 - The transceiver returns to the DR mode screen, and the selected repeater is set in “FROM.”

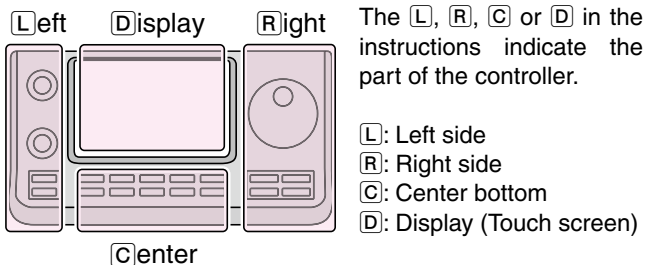

How to switch the repeater group:

➤ To switch the repeater group, while in the DR mode, push **QUICK**(**C**), and then touch “Group Select”

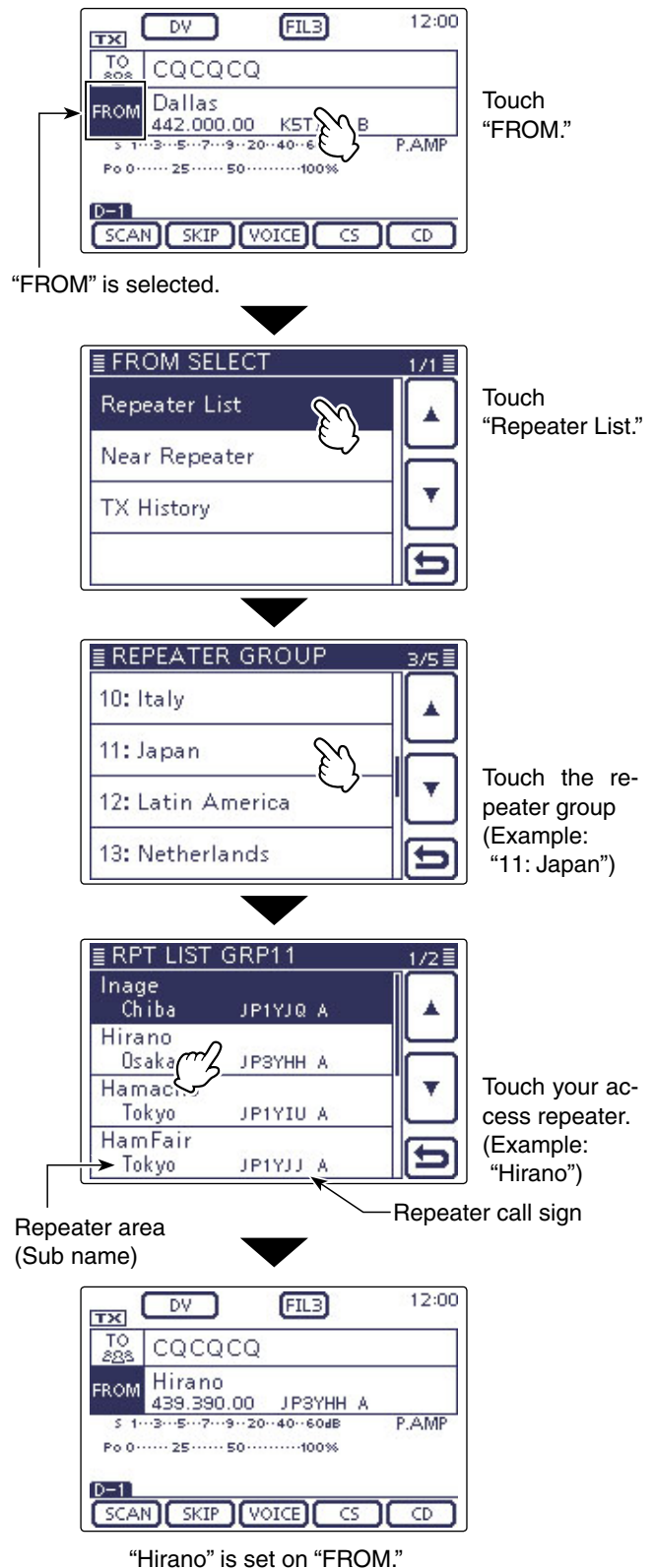

/// The repeater list, described in this manual, may differ from your transceiver’s preloaded list.

“FROM” (Access repeater) setting (Continued)

◇ Using the DR mode scan

The DR mode scan is useful to find a repeater. To quickly find a repeater, the DR mode scan skips repeaters that are not specified as an access repeater. (The “USE (FROM)” setting is set to “NO” (SKIP is set) on the repeater list.)

Example: Select the “Hirano” repeater using the DR mode scan.

- ① Push **[DR]**(C) to select the DR mode.
- ② Push **[MENU]**(C) to display the “D-1” screen (D-1 menu).
- ③ Touch **[SCAN]**(D) to start the DR mode scan.
 - The frequency decimal point and “FROM” blink while scanning.
 - The repeaters in the repeater list are sequentially displayed.
 - The scan pauses when a signal is received. The scan resumes the same as other scans. (FM sec. 12)
- ④ When the transceiver receives a signal from a repeater, the scan stops, then touch **[SCAN]**(D).
 - The DR mode scan is cancelled.

/// You can skip certain repeaters as a scan target. You can also skip all repeaters in certain groups from a scan. See FM sec. 9 for details.

/// **NOTE:**
Even if the transceiver receives a signal from a repeater, the repeater may not receive the transceiver’s signal, because the repeater’s output power is higher than the transceiver’s.

The DR mode scan also scans simplex frequencies if they are entered in the repeater list.

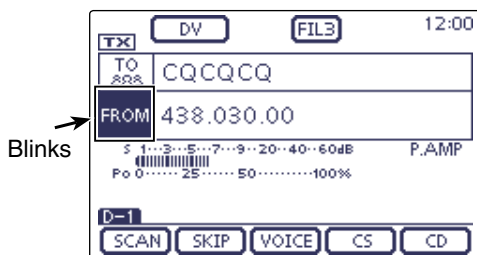

While receiving a signal on 438.030.

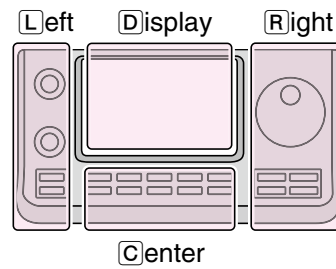

The **[L]**, **[R]**, **[C]** or **[D]** in the instructions indicate the part of the controller.

- [L]**: Left side
- [R]**: Right side
- [C]**: Center bottom
- [D]**: Display (Touch screen)

Touch **[SCAN]**

Blinks

The repeaters are sequentially displayed.

While DR mode scanning

Means “JM1ZLK” is using the “Hirano” repeater.

Touch **[SCAN]**

While receiving a signal from a repeater

“Hirano” repeater is selected in “FROM.”

“FROM” (Access repeater) setting (Continued)

◇ Using the Repeater Search function

The transceiver searches for the nearest repeater by using your own and the repeater’s position. The nearest repeater in your transceiver’s repeater list is displayed as the available choices.

To receive your own position, connect an external NMEA format compatible receiver to the transceiver according to the instructions. (See FM sec. 10 for connecting the third party GPS receiver)

If you set your position into the “Manual” item of the “GPS Set” Set mode, and if you use the transceiver as a base station, you can use the Repeater Search function without needing to receive any other position data. (See FM sec. 10 for Manual position entry)

1. Receiving your own position from the GPS receiver

- ① Push **SET**(C) to select the Set mode.
- ② Touch the “GPS Select” item of the “GPS Set” Set mode.
 - GPS > GPS Set > **GPS Select**
 - If the specified item is not displayed, touch [▲] or [▼](D) one or more times to select the page.
- ③ Touch “External GPS.”
 - When you know your position and operate as a base station, the Repeater Search function can be used if “Manual” is selected.
- ④ Push **SET**(C) to save, and exit the Set mode.
 - The GPS icon blinks when receiving data.
 - If “Manual” was selected, the icon does not appear.
 - ⇄ ■ ⇄ ■ ⇄ (Disappears)
 - The GPS icon stops blinking when valid data is received.
 -
 - It may take only a few seconds to receive. But depending on the environment, it may take a few minutes. If you have difficulties receiving, we recommend that you try a different location.

▨ If the “DATA 1” item in the “Connectors” Set mode is set to other than “GPS” (default), set to “GPS.” (p.6-8)

▨ Connectors > USB2/DATA1 Function > **DATA1 Function**

▨ Set the “GPS Receiver Baud rate” item in the “GPS” Set mode, according to your GPS receiver. (Default: 4800)

▨ GPS > GPS Set > **GPS Receiver Baud rate**

The **L**, **R**, **C** or **D** in the instructions indicate the part of the controller.

L: Left side, **R**: Right side, **C**: Center bottom
D: Display (Touch screen)

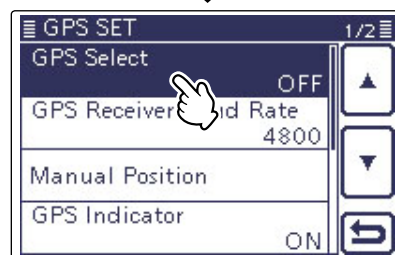
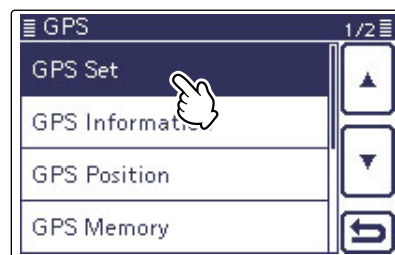
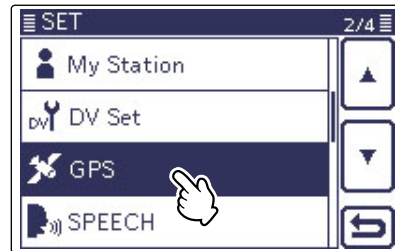

“GPS Select” screen

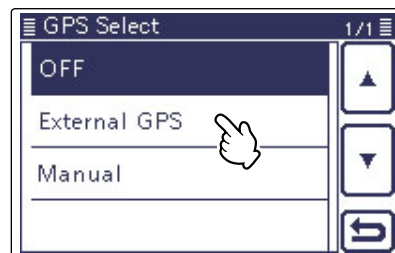

Appears when valid data is received.

In the DR mode

Continued on the next page.

“FROM” (Access repeater) setting

◇ Using the Repeater Search function (Continued)

2. Selecting the access repeater from the Near Repeater list

- ① Push **DR**(**C**) to select the DR mode.
- ② Check whether or not “FROM” is selected.
 - If “FROM” is not selected, touch the “FROM” field.
- ③ Touch the “FROM” field.
 - The “FROM SELECT” screen appears.
- ④ Touch “Near Repeater.”
 - The “NEAR REPEATER” screen appears.
 - Up to 20 of the nearest repeaters are displayed.
- ⑤ Touch the repeater as your access repeater, according to the distance from your position to the repeater.
 - Example: “Hirano”
 - The transceiver returns to the DR mode screen, and the selected repeater is set in “FROM.”

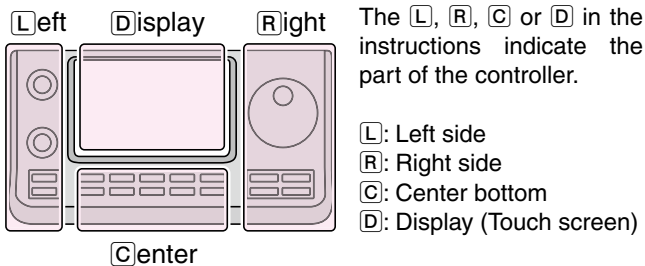
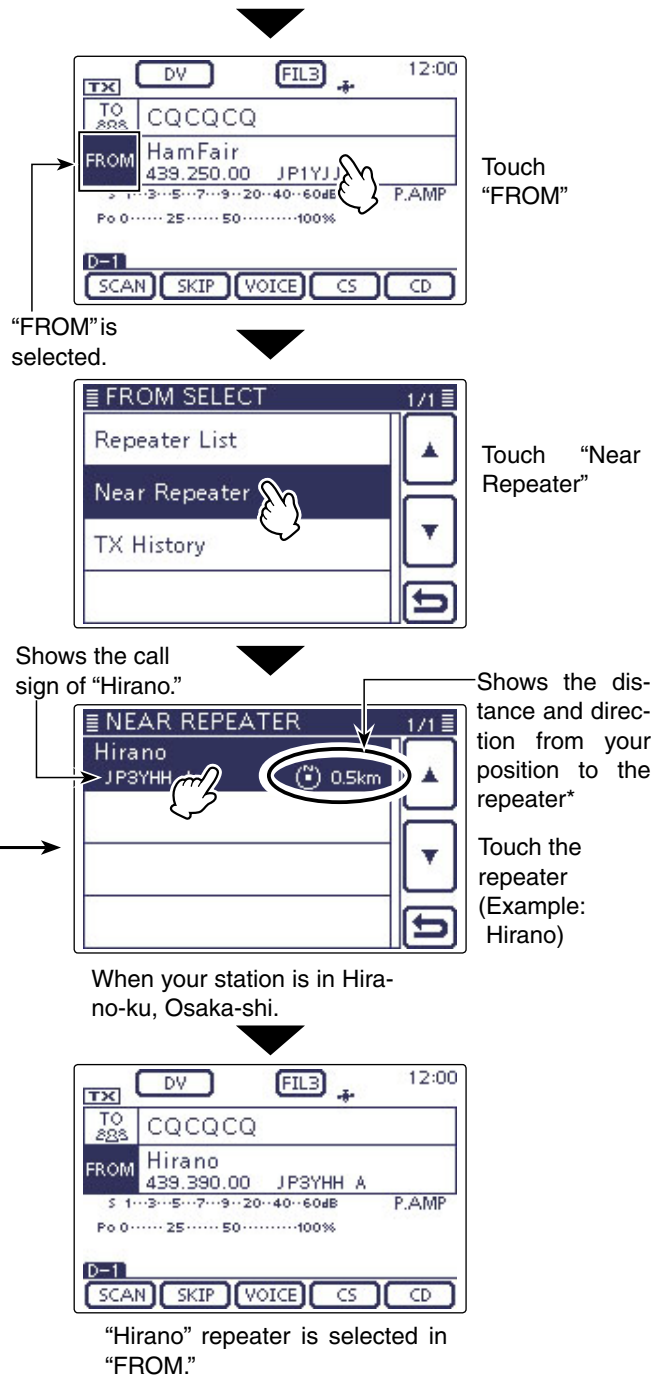

NOTE:
 When using the Repeater Search function, be sure to first receive your own position data.

- If no repeater is found in a 160 kilometers range, screen 1, as shown to the right, will be displayed.
- If the last received position can be used, screen 2, as shown to the right, will be displayed.

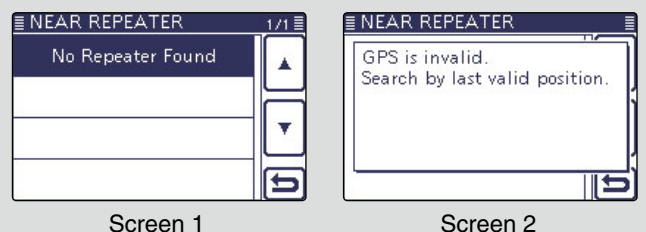

“FROM” (Access repeater) setting (Continued)

◇ Using the TX History

Repeaters you transmitted to in the DR mode are stored in the TX History, and you can select a repeater from the TX History as your access repeater. The TX History stores up to 10 of the latest “FROM” (Access repeater) repeaters.

- ① Push **DR**(**C**) to select the DR mode.
- ② Check whether or not “FROM” is selected.
 - If “FROM” is not selected, touch the “FROM” field.
- ③ Touch the “FROM” field.
 - The “FROM SELECT” screen appears.
- ④ Touch “TX History.”
 - The “TX HISTORY” screen appears.
- ⑤ Touch the repeater to use as your access repeater.
 - Example: “Hirano”
 - The transceiver returns to the DR mode screen, and the selected repeater is set in “FROM.”

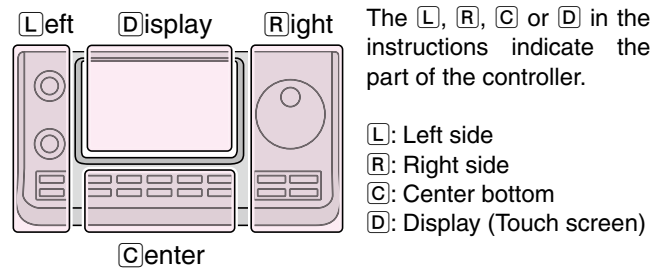

Touch “FROM”

“FROM” is selected.

Touch “TX History”

Touch the repeater (Example: Hirano)

“Hirano” repeater is selected in “FROM.”

When you push **QUICK**(**C**) in the step ④, you can display detailed repeater information on the TX HISTORY screen, or delete it from there.



“TO” (Destination) setting

The destination repeater or station must be set to “TO” when you transmit a call in the DV mode. You have eight ways to set the destination. Click the title shown below to jump to the specified page.

“Hamacho” repeater is set in “TO.”



Setting by the Dial

Rotate the Dial or [M-CH] (L) to select the preset repeater or Your Call Sign that is displayed on the DR mode screen. (This operation is disabled when “CQCQCQ” is set.) Or, rotate [BANK] (L) to select the repeater group.

To make a Local Area CQ call

“Local CQ” setting (p. 5-14)
Set “CQCQCQ” in “TO” (Destination).

To make a Gateway CQ call

“Gateway CQ” setting (p. 5-15)
Select a repeater from the repeater list, if you want to make a Gateway CQ call.

To make a call to a specific station

“Your Call Sign” setting (p. 5-16)
Select the station call sign in the Your Call Sign memory.

To select from RX History

Setting from RX History (p. 5-17)
When you receive a call, the repeater or caller station data is stored in RX History. You can select the destination from the record.

To select from TX History

Setting from TX History (p. 5-18)
When you transmit a call, the destination repeater or called station data is stored in TX History. You can select the destination from the record.

To directly input the destination station call sign

Direct Input (UR) (p. 5-19)
Directly input the destination station call sign.

To directly input the destination repeater call sign

Direct Input (RPT) (p. 5-20)
Directly input the destination repeater call sign.

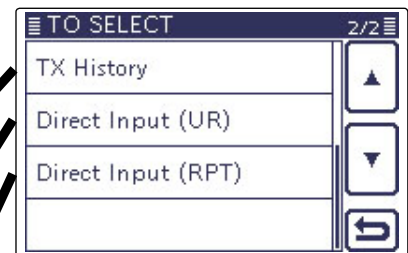

[TO SELECT] screen

How to switch the repeater group:
When “Local CQ” or “Gateway CQ” is selected, you can switch the repeater group. While in the DR mode, push [QUICK] (C), and then touch “Group Select.”



“TO” (Destination) setting (Continued)

◇ Using the “Local CQ” (Local Area call)

When “Local CQ” is selected in the “TO SELECT” screen, “CQCQCQ” is set in “TO.”

Example: Making a Local area call by accessing the “Hirano” repeater.

- ① Push **[DR]**(**[C]**) to select the DR mode.
- ② Check whether or not “TO” is selected.
 - If “TO” is not selected, touch the “TO” field.
- ③ Touch the “TO” field.
 - The “TO SELECT” screen appears.
- ④ Touch “Local CQ.”
 - The transceiver returns to the DR mode screen, and “CQCQCQ” is displayed in “TO.”

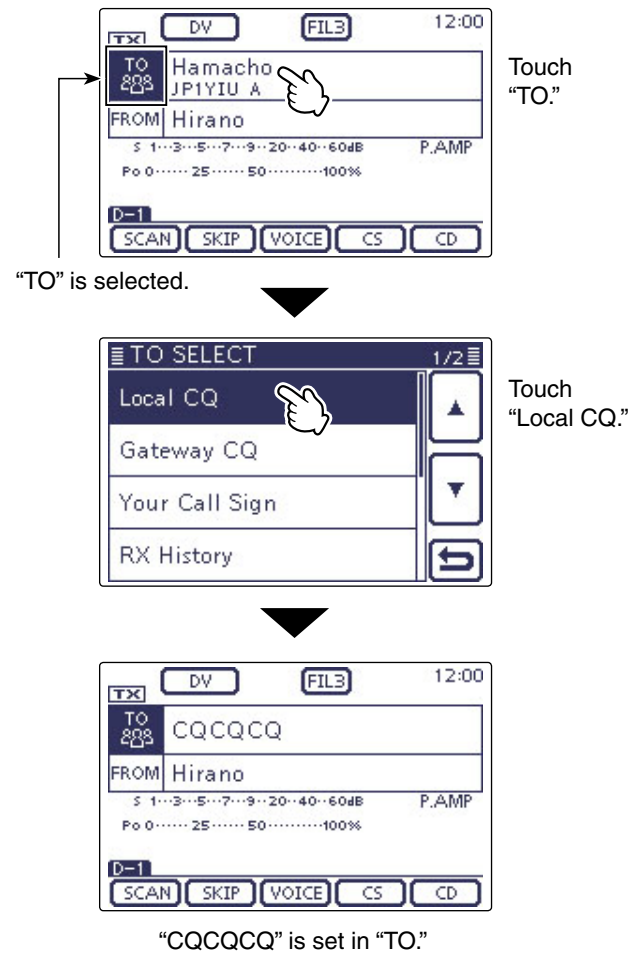
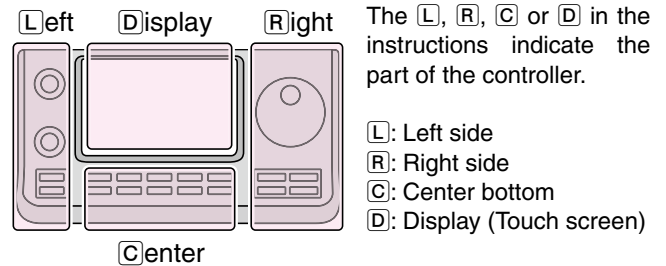

“TO” (Destination) setting (Continued)

◇ Using the “Gateway CQ” (Gateway call)

When “Gateway CQ” is selected in the “TO SELECT” screen, the repeater to make a gateway CQ call can be selected from the repeater list.

Example: Making a gateway CQ call to (Japan; Hamacho) from the “Hirano” repeater.

- ① Push **DR**(**C**) to select the DR mode.
- ② Check whether or not “TO” is selected.
 - If “TO” is not selected, touch the “TO” field.
- ③ Touch the “TO” field.
 - The “TO SELECT” screen appears.
- ④ Touch “Gateway CQ.”
 - The “REPEATER GROUP” screen is displayed.
- ⑤ Touch the repeater group where your destination repeater is listed.
 - Example: “11: Japan”
- ⑥ Touch the destination repeater.
 - Example: “Hamacho”
 - The transceiver returns to the DR mode screen, and “Hamacho” is displayed in “TO.”

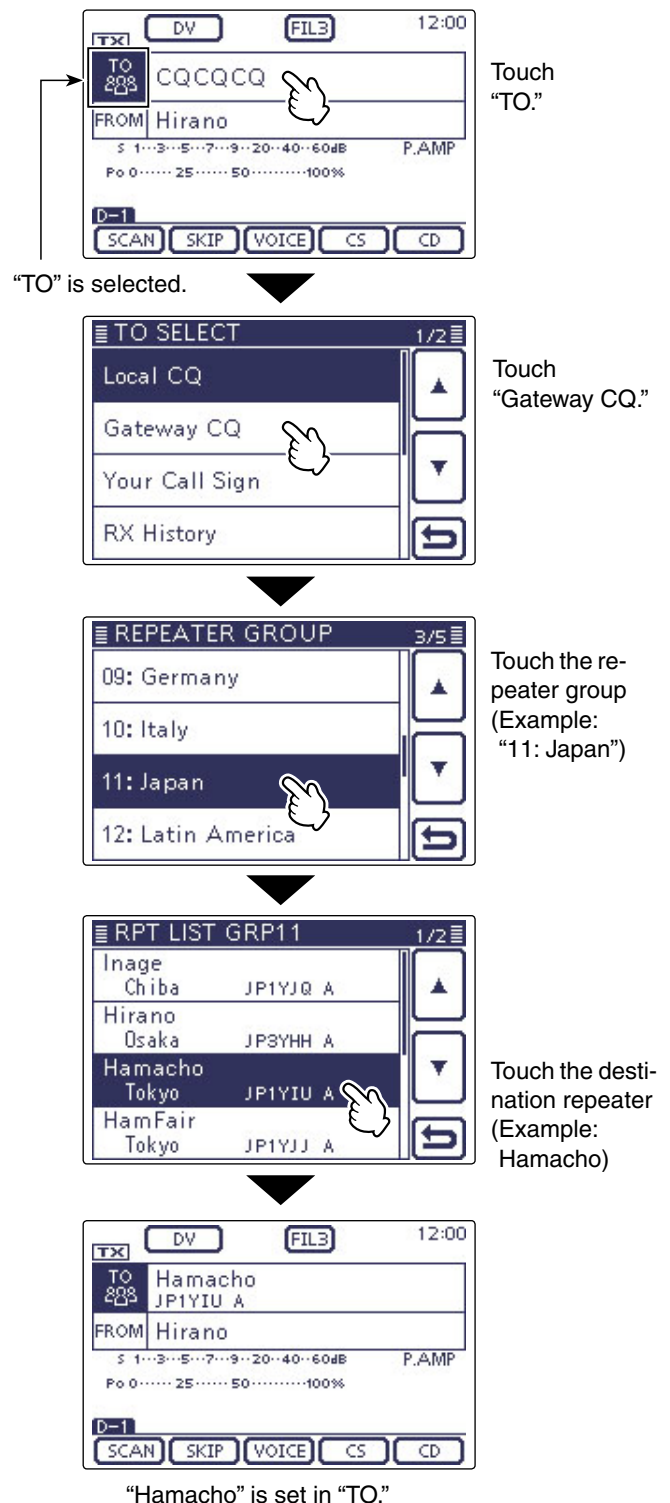
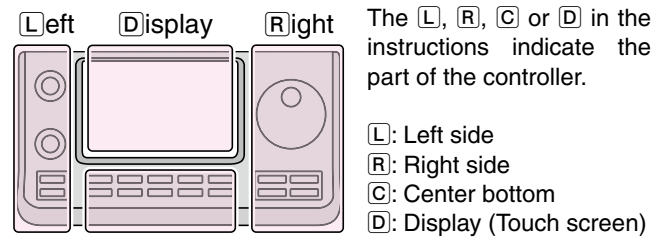

After selecting a repeater, you can select another repeater preset in your transceiver by rotating **[DIAL]** or **[M-CH]**(**L**).



Or, you can select another repeater group by rotating **[BANK]**(**L**).



“TO” (Destination) setting (Continued)

◇ Using the “Your Call Sign”

The “Your Call Sign” memory stores the programmed “UR” (destination) call sign.

When you select an individual station call sign for the “TO” (Destination) setting using “Your Call Sign,” a gateway call can be made.

When you call the destination through a gateway, the signal is automatically sent to the last repeater that the station accessed.

So, even if you don't know where the station is, you can make a call.

NOTE: If the repeater, set to “FROM” (Access Repeater) has no Gateway call sign, you cannot make a gateway call.

Example: Select “TOM” from the “Your Call Sign.”

- ① Push **DR**(**C**) to select the DR mode.
- ② Check whether or not “TO” is selected.
 - If “TO” is not selected, touch the “TO” field.
- ③ Touch the “TO” field.
 - The “TO SELECT” screen appears.
- ④ Touch “Your Call Sign.”
 - The “YOUR CALL SIGN” screen is displayed.
- ⑤ Touch the destination name or call sign.
 - Example: “TOM”
 - The transceiver returns to the DR mode screen, and “TOM” is displayed in “TO.”

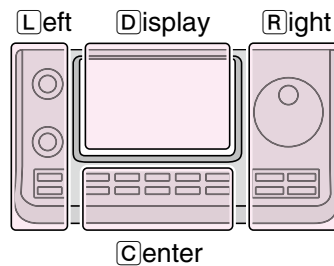

The **L**, **R**, **C** or **D** in the instructions indicate the part of the controller.

- L**: Left side
- R**: Right side
- C**: Center bottom
- D**: Display (Touch screen)



Touch “TO.”

“TO” is selected.



Touch “Your Call Sign.”



Touch the destination. (Example: “TOM”)

The name and call sign of the selected station is displayed.



“TOM” is set in “TO.”

After selecting a destination, you can select another station preset in your transceiver by rotating the Dial or **[M-CH]**(**L**).



“TO” (Destination) setting (Continued)

◇ Using the RX History

When a call is received in the DV mode, the call data is stored in the RX History.
Up to 50 Callers, and only the last Called call signs can be stored.

Example: Select “TOM” from RX History.

- ① Push **DR**(**C**) to select the DR mode.
- ② Check whether or not “TO” is selected.
 - If “TO” is not selected, touch the “TO” field.
- ③ Touch the “TO” field.
 - The “TO SELECT” screen appears.
- ④ Touch “RX History.”
 - The “RX HISTORY” screen appears.
- ⑤ Touch the destination name or call sign.
 - Example: “TOM”
 - The transceiver returns to the DR mode screen, and “TOM” is displayed in “TO.”

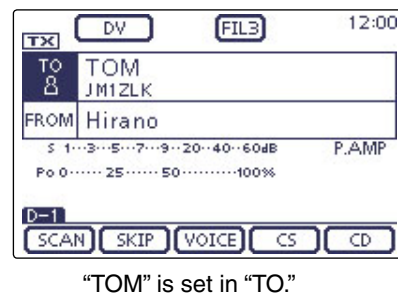
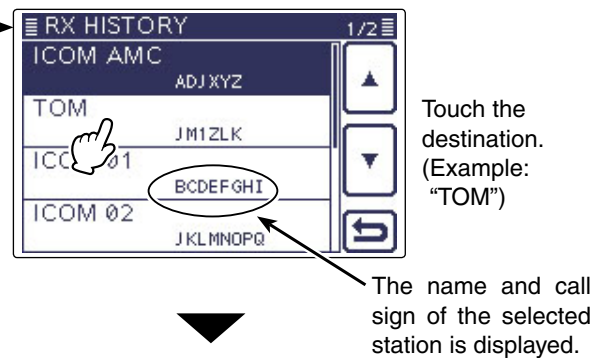
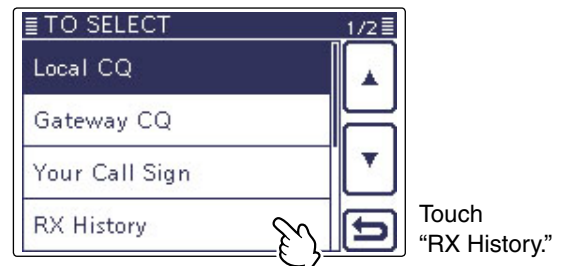
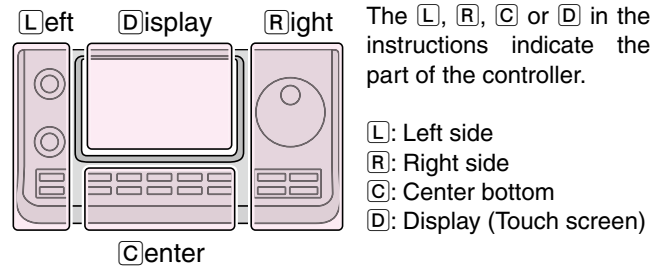

To add the selected RX HISTORY data to memory, push **QUICK**(**C**) on the RX HISTORY screen, then touch “Add To your Memory.”



“TO” (Destination) setting (Continued)

◇ Using the TX History

The TX History stores the name and/or call sign of up to 20 “TO” (Destination) settings that were used when you made the calls.

NOTE: If you never transmit a call in the DV mode, you cannot select “TO” (destination) from the TX History.

Example: Select the “Dallas” repeater in the TX History.

- ① Push **[DR]**(**[C]**) to select the DR mode.
- ② Check whether or not “TO” is selected.
 - If “TO” is not selected, touch the “TO” field.
- ③ Touch the “TO” field.
 - The “TO SELECT” screen appears.
- ④ Touch **[▼]** to display the next page.
- ⑤ Touch “TX History.”
 - The “TX HISTORY” screen appears.
- ⑥ Touch the destination name or call sign.
 - Example: “Dallas”
 - The transceiver returns to the DR mode screen, and “Dallas” is displayed in “TO.”

The **[L]**, **[R]**, **[C]** or **[D]** in the instructions indicate the part of the controller.
[L]: Left side, **[R]**: Right side, **[C]**: Center bottom
[D]: Display (Touch screen)

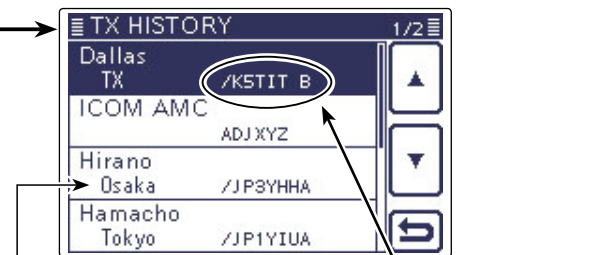
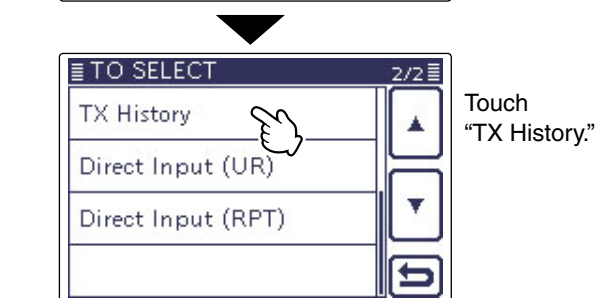
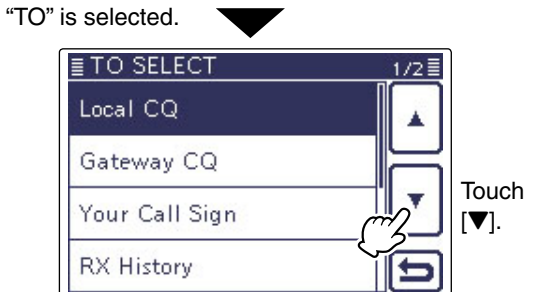

The Sub name is displayed when a repeater is selected.



“Dallas” is set in “TO.”

If you push **[QUICK]**(**[C]**) on the TX HISTORY screen, you can add the selected TX HISTORY data to memory, or delete it from there.



“TO” (Destination) setting (Continued)

◇ Directly inputting (UR)

The destination station call sign can be directly input.

Example: Directly input the call sign “JM1ZLK.”

- ① Push **[DR]**(**C**) to select the DR mode.
- ② Check whether or not “TO” is selected.
 - If “TO” is not selected, touch the “TO” field.
- ③ Touch the “TO” field.
 - The “TO SELECT” screen appears.
- ④ Touch **[▼]** to display the next page.
- ⑤ Touch “Direct Input (UR).”
 - The “DIRECT INPUT (UR)” screen appears.
- ⑥ Touch the desired block one or more times to select the desired character or symbol.
 - (Example: J)
 - A to Z, 0 to 9 and / can be selected.
 - Touch “AB↔12” to toggle between the Alphabet input and Number input mode.
 - Touch **[CLR]**(**D**) to delete the selected character, symbol or number.
 - Touch “_” to input a space.
- ⑦ Touch **[←]**(**D**) to move the cursor backwards, or touch **[→]**(**D**) to move the cursor forwards.
- ⑧ Repeat steps ⑥ and ⑦ to program a call sign of up to 8 characters, including spaces, and then touch **[ENT]**(**D**).
 - (Example: First, J, then M, then 1, then Z, then L, then K.)
 - The transceiver returns to the DR mode screen, and “JM1ZLK” is displayed in “TO.”
 - After programming, you can correct the call sign in the DIRECT INPUT (UR) screen.
 - The programmed call sign remains on the DIRECT INPUT (UR) screen, until inputting a new call sign.

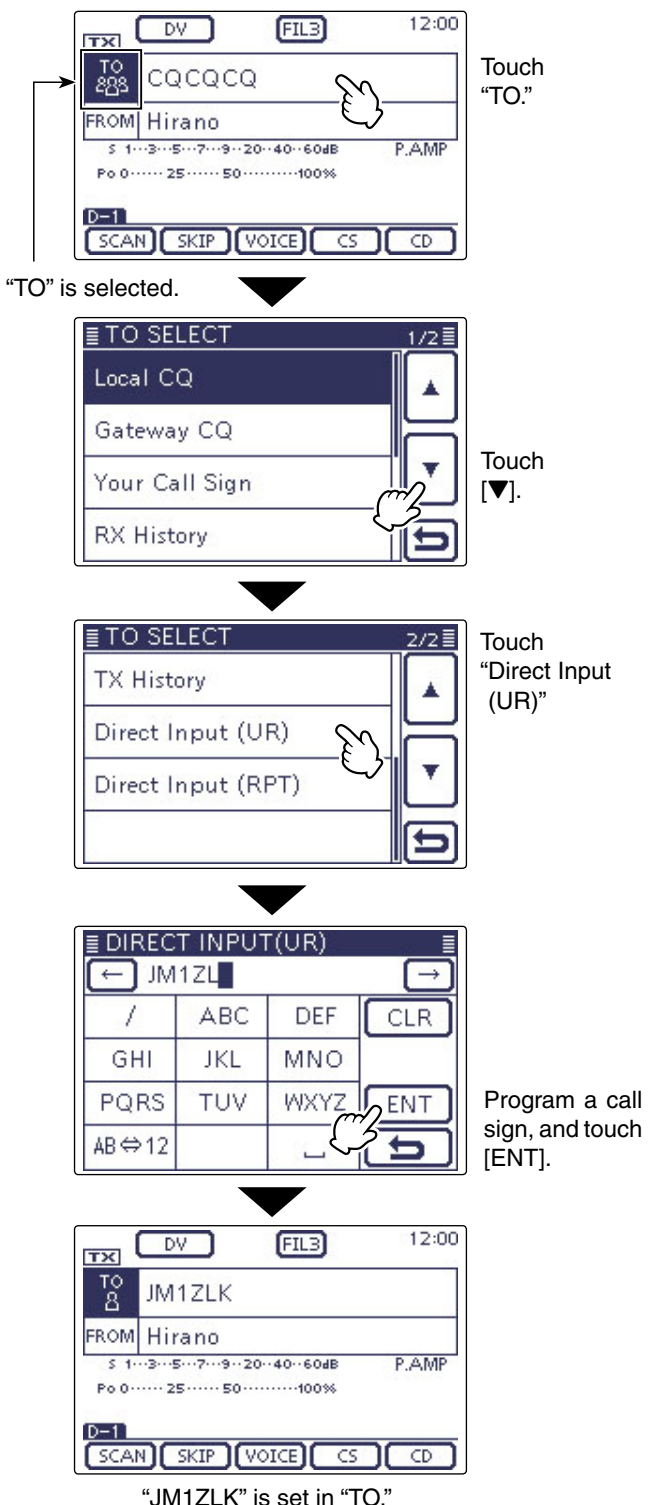
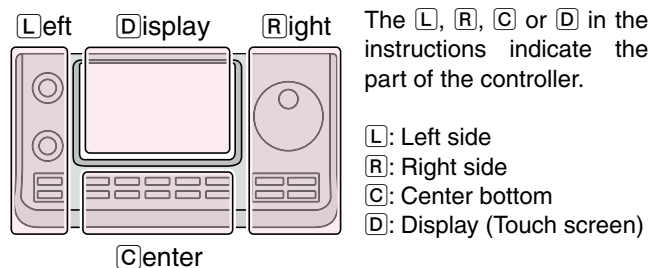

If the programmed call sign is duplicated in “Your Call Sign” memory, the name is displayed. (Only when the name has been programmed.)



“TO” (Destination) setting (Continued)

◇ Directly inputting (RPT)

The destination repeater call sign can be directly input.

Example: Directly input the call sign “JP3YDH”

- ① Push **[DR]**(C) to select the DR mode.
- ② Check whether or not “TO” is selected.
 - If “TO” is not selected, touch the “TO” field.
- ③ Touch the “TO” field.
 - The “TO SELECT” screen appears.
- ④ Touch **[▼]** to display the next page.
- ⑤ Touch “Direct Input (RPT).”
 - The “DIRECT INPUT (RPT)” screen appears.
- ⑥ Touch the desired block one or more times to select the desired character or symbol. (Example: J)
 - A to Z, 0 to 9 and / can be selected.
 - Touch “AB↔12” to toggle between the Alphabet input and Number input mode.
 - Touch **[CLR]**(D) to delete the selected character, symbol or number.
 - Touch “_” to input a space.
- ⑦ Touch **[←]**(D) to move the cursor backwards, or touch **[→]**(D) to move the cursor forwards.
- ⑧ Repeat steps ⑥ and ⑦ to program a call sign of up to 8 characters, including spaces, and then touch **[ENT]**(D). (Example: First, J, then P, then 3, then Y, then D, then H.)
 - The transceiver returns to the DR mode screen, and “JP3YDH” is displayed in “TO.”
 - After programming, you can correct the call sign in the DIRECT INPUT (RPT) screen.
 - The programmed call sign remains on the DIRECT INPUT (RPT) screen, until inputting a new call sign.

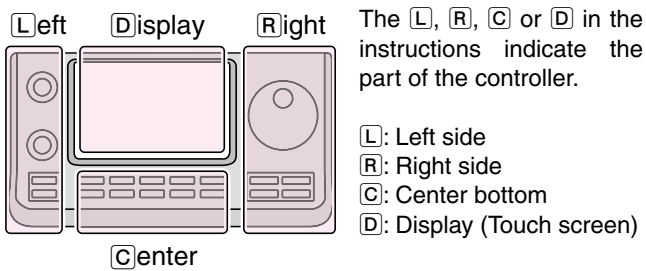
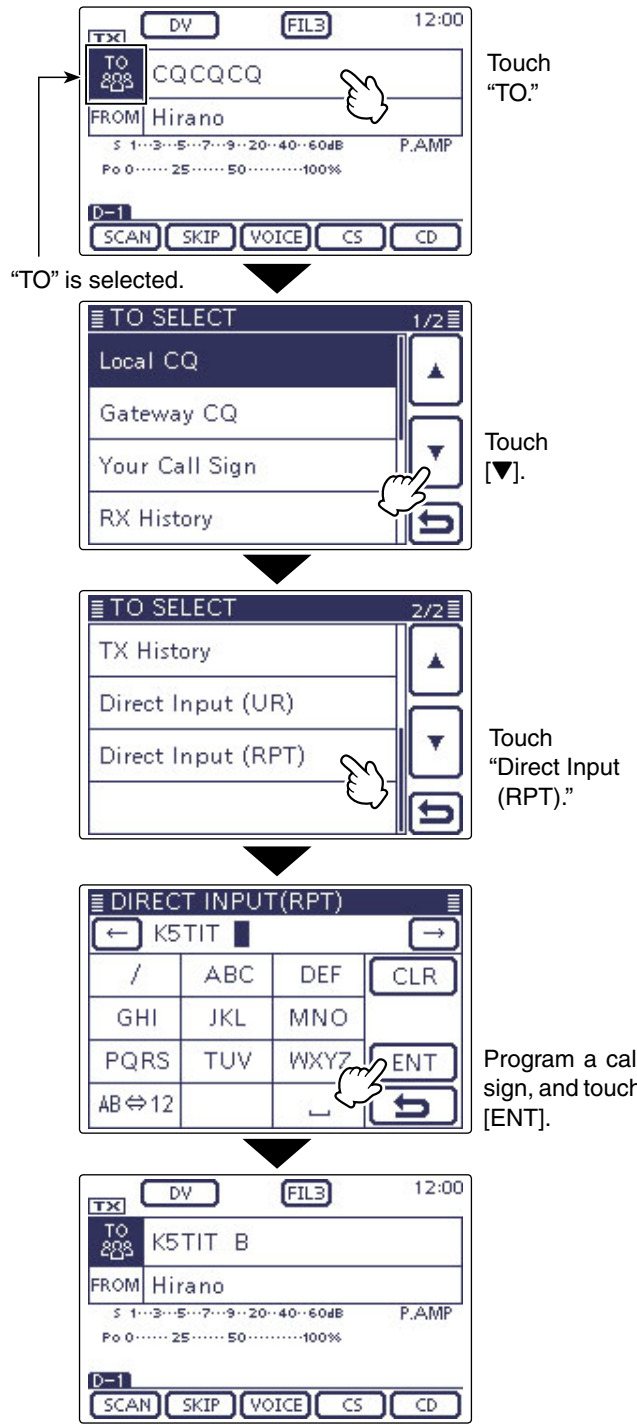

If the programmed call sign is duplicated to the repeater list, the name is displayed. (Only when the name has been programmed.)

The following settings are also correct.

The repeater node* is input.

“/” is input. In this case, the call sign is of a repeater for a Gateway call.

*Although the repeater node letter is ‘B’ for 430 MHz band, ‘A’ is used in Japan. See page 5-1 for details.

Section 6 SET MODE

Set mode description.....	6-2
◇ The Set mode settings	6-2
Set mode items and Default settings.....	6-3

- Section 1 PANEL DESCRIPTION**
- Section 2 INSTALLATION AND CONNECTIONS**
- Section 3 BASIC OPERATION**
- Section 4 D-STAR INTRODUCTION**
- Section 5 D-STAR OPERATION <BASIC>**
- Section 6 SET MODE**
- Section 7 INFORMATION**

'FM' means 'Full Manual.'
'sec. * *' means section number.

So when '(FM sec. * *)' is described on this manual, see the PDF type Full Manual's section number for your reference.

Set mode description

The Set mode is used to program infrequently changed values or function settings.

NOTE: The Set mode is constructed in a tree structure. You may go to the next tree level, or go back a level, depending on the selected item.

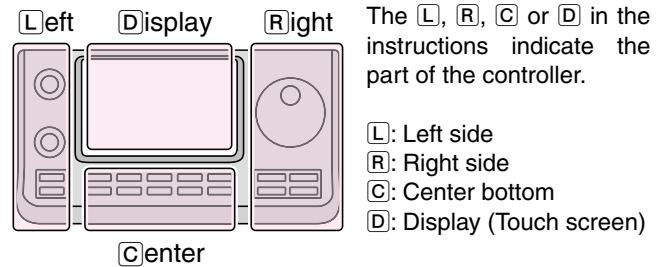

Example: Change the “Memopad Numbers” option to “10.”

◆ The Set mode settings

- ① Push **SET**(**C**) to enter the Set mode.
- ② If the specified item is not displayed, touch **[▲]** or **[▼]** (**D**) one or more times to select the page.
 - If **[▲]**(**D**) or **[▼]**(**D**) is continuously held down, the pages are quickly scrolled.
 - Rotating the Dial also selects the pages.
- ③ Touch a desired item to go to the next level.
- ④ Repeat steps ② and ③ to show the desired item’s setting screen.
 - To go back the previous tree level, touch **[↶]**(**D**), or **MENU**(**C**).
- ⑤ Touch a desired option shown on the display, or **[+]**/**[−]**(**D**) to adjust a level.
 - When you touch an option, it is automatically saved and the screen returns to the previous display.
 - Rotating the Dial also adjusts the level.
 - Push **QUICK**(**C**), and then touch “Default” to reset to the default setting, if desired.
 - To set other item, touch **[↶]**(**D**), or **MENU**(**C**) to go back a tree level.
- ⑥ Push **SET**(**C**) to exit the Set mode.

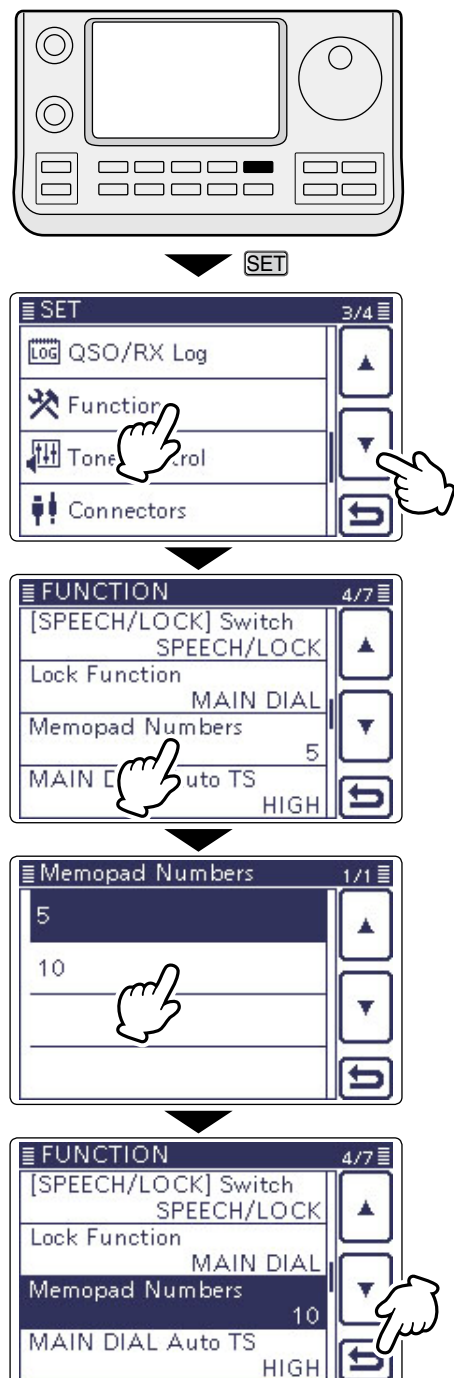

Set mode items and Default settings

- Call sign (FM sec. 9)
- RX History (FM sec. 9)
- MY Station (Section 4)
- GPS (FM sec. 10)
- SD Card (FM sec. 13)

/// **NOTE:** The default settings shown below in bold are for the USA version.

/// The default settings may differ, depending on your transceiver version.

Voice Memo In this item, set the TX/RX voice recording options.

QSO Recorder		
<<REC Start>>*		Starts recording the TX/RX audio.
Play Files*		Selects to playback or delete the recorded audio.
Recorder Set		
REC Mode	TX&RX or RX Only	Selects to record the TX audio or not.
RX REC Condition	Always or Squelch Auto	Selects whether or not the squelch status affects the RX voice audio recording.
File Split	OFF or ON	Selects whether or not to automatically create a new file after each transmission, reception, or each time the squelch opens or closes. Even if the squelch is closed, a new file is created when the "RX REC Condition" item is set to "Squelch Auto."
PTT Auto REC	OFF or ON	Turns the PTT Automatic Recording function ON or OFF.
Player Set		
Skip Time	3sec, 5sec, 10sec or 30sec	Sets the Skip time to rewind or forward the recorded audio when you push the fast-rewind or fast-forward key during playback.
DV Auto Reply*		Records a voice audio to use for the Auto Reply function in the DV mode.

* Be sure to insert the SD card into the transceiver before selecting these items.

DV Set In this item, set infrequently changed values or functions in the DV mode.

Standby Beep	OFF, ON or ON (to me: High Tone)	Selects whether or not to sound a beep after a received signal disappears.
Auto Reply	OFF , ON or Voice	Selects whether or not to automatically reply to a call addressed to your own call sign.
DV Data TX	PTT or Auto	Selects to manually or automatically transmit low speed data.
Digital Monitor	Auto , Digital or Analog	Selects the DV mode RX monitoring when [XFC] is held down.
Digital Repeater Set	OFF or ON	Turns the digital repeater setting function ON or OFF. This function is usable in any DV mode except the DR mode.
RX Call Sign Write	OFF or Auto	Turns the RX call sign automatic write function ON or OFF. This function is usable in any DV mode except the DR mode.
RX Repeater Write	OFF or Auto	Turns the repeater call sign automatic write function ON or OFF. This function is usable in any DV mode except the DR mode.
DV Auto Detect	OFF or ON	Turns the DV mode automatic detect function ON or OFF.
RX Record (RPT)	ALL or Latest Only	Selects whether to record all calls or only the latest call, when the received signal includes a status message ("UR?" or "RPT?") that is sent back from the access repeater.
BK	OFF or ON	Turns the BK (Break-in) function ON or OFF. The BK function allows you to break into a conversation between two stations with call sign squelch enabled.
EMR	OFF or ON	Turns the EMR (Enhanced Monitor Request) communication mode ON or OFF.
EMR AF Level	0%~ 50% ~100%	Sets the audio output level when an EMR mode signal is received.

Set mode items and Default settings (Continued)

/// **NOTE:** The default settings shown below in bold are for the USA version.
 /// The default settings may differ, depending on your transceiver version.

SPEECH		
In this item, set the Speech options.		
RX Call Sign SPEECH	OFF, ON (Kerchunk) or ON (All)	Selects the RX call sign speech function option while ON, or turn it OFF.
RX>CS SPEECH	OFF or ON	Turns the RX>CS Speech function ON or OFF.
S-Level SPEECH	OFF or ON	Turns the Signal Strength Level Speech function ON or OFF.
MODE SPEECH	OFF or ON	Turns the Operating Mode Speech function ON or OFF.
SPEECH Language	English or Japanese	Selects either English or Japanese as the desired speech language.
Alphabet	Normal or Phonetic Code	Selects the alphabet character announcement type.
SPEECH Speed	Slow or Fast	Selects Slow or Fast speech speed.
SPEECH Level	0%~ 50% ~100%	Sets the volume level for the voice synthesizer.
QSO/RX Log		
In this item, set the QSO/RX History Log options.		
QSO Log* ¹	OFF or ON	Selects whether or not to make a communication log on the SD card.
RX History Log* ¹	OFF or ON	Selects whether or not to make a DV mode's receive history log on the SD card.
CSV Format		
Separator/Decimal	Sep [.] Dec [.] * ² , Sep [;] Dec [.] or Sep [;] Dec [.]	Selects the separator and the decimal character for the CSV format.
Date	yyyy/mm/dd, mm/dd/yyyy * ² or dd/mm/yyyy	Selects the date format.
* ¹ Be sure to insert the SD card into the transceiver before selecting these items.		
* ² The default value may differ, depending on the transceiver version.		

Set mode items and Default settings (Continued)

/// **NOTE:** The default settings shown below in bold are for the USA version.

/// The default settings may differ, depending on your transceiver version.

Function	In this item, set the function options.	
Monitor	OFF or ON	Selects whether or not to monitor your transmit signal in any mode other than CW.
Monitor Level	0%~ 50% ~100%	Sets the monitor level.
Beep Level	0%~ 50% ~100%	Sets the beep output level.
Beep Level Limit	OFF or ON	Selects whether or not to limit the volume to the specified level, and further rotation of the [AF] control will not increase the level.
Beep (Confirmation)	OFF or ON	Turns the confirmation beep tones ON or OFF.
Band Edge Beep	OFF, ON (Default) , ON (User) or ON (User) & TX Limit	Selects whether or not to sound a beep when you tune outside of, or back into the amateur band's frequency range.
User Band Edge	1: 1.800.000–1.999.999 2: 3.500.000–3.999.999 3: 5.255.000–5.405.000 4: 7.000.000–7.300.000 5: 10.100.000–10.150.000 6: 14.000.000–14.350.000 7: 18.068.000–18.168.000 8: 21.000.000–21.450.000 9: 24.890.000–24.990.000 10: 28.000.000–29.700.000 11: 50.000.000–54.000.000 12: 144.000.000–148.000.000 13: 430.000.000–450.000.000 14~30: (blank)	Selects the user band frequency range to sound a beep when the Band Edge Beep function is set to "ON (User)" or "ON (User) & TX Limit," and you tune outside of, or back into a programmed range.
RF/SQL Control	Auto, SQL or RF+SQL	Select the function of the [RF/SQL] control.
TX Delay		
HF	OFF , 10ms, 15ms, 20ms, 25ms or 30ms	Sets the transmission's timing of the IC-7100 to prevent any external equipment that is connected from damage by the transmitted RF.
50M	OFF , 10ms, 15ms, 20ms, 25ms or 30ms	See HF above.
144M	OFF , 10ms, 15ms, 20ms, 25ms or 30ms	See HF above.
430M	OFF , 10ms, 15ms, 20ms, 25ms or 30ms	See HF above.
Time-Out Timer	OFF , 3min, 5min, 10min, 20min or 30min	Selects the Time-Out Timer time options to prevent an accidental prolonged transmission.
PTT Lock	OFF or ON	Selects whether or not to inhibit transmission.
SPLIT/DUP		
Quick SPLIT	OFF or ON	Turns the Quick SPLIT function ON or OFF.
SPLIT Offset	-9.999 MHz~ 0.000 MHz ~+9.999 MHz	Sets the frequency offset for the Split function.
SPLIT LOCK	OFF or ON	Turns the SPLIT LOCK function ON or OFF.
DUP Offset	0.0000 MHz~9.9999 MHz (The default value may differ, depending on the frequency band and the transceiver version.)	Sets the frequency offset for repeater operation.
One Touch Repeater	DUP- or DUP+	Selects the duplex direction for the One Touch Repeater function.
Auto Repeater	OFF, ON (DUP) or ON (DUP,TONE)	Turns the Auto Repeater function ON or OFF.
Tuner		
Auto Start	OFF or ON	Turns the automatic antenna tuner function ON or OFF.

Set mode items and Default settings (Continued)

/// **NOTE:** The default settings shown below in bold are for the USA version.
 /// The default settings may differ, depending on your transceiver version.

PTT Start [TUNER] Switch	OFF or ON Manual or Auto	Turns the PTT Tuner Start function ON or OFF. Selects whether or not to store the AT-180's status by each band.
[SPEECH/LOCK] Switch	SPEECH/LOCK , LOCK/SPEECH	Selects the function for [SPEECH] when pushed or held down.
Lock Function	MAIN DIAL or PANEL	Select the target to be locked when the Lock function is activated.
Memopad Numbers	5 or 10	Sets the number of usable memopad channels.
MAIN DIAL Auto TS	OFF, LOW or HIGH	Selects an option for the automatic tuning step function. When rapidly rotating the main dial, the tuning step automatically changes according to the setting.
MIC Up/Down Speed [NOTCH] Switch (SSB)	Slow or Fast Auto, Manual or Auto/Manual	Selects the microphone's [▲]/[▼] key speed. Selects the notch function for the SSB mode.
[NOTCH] Switch (AM)	Auto, Manual or Auto/Manual	Selects the notch function for the AM mode.
SSB/CW Sync Tuning	OFF or ON	Turns the Synchronous Tuning function ON or OFF to shift the operating frequency by the offset amount to keep receiving a signal when the operating mode is changed between SSB and CW.
CW Normal Side	LSB or USB	Sets the carrier point for CW normal mode operation to the LSB side or the USB side.
VOICE 1st Menu	VOICE-Root or VOICE-TX	Select whether or not to directly select the "VOICE TX" screen, skipping the "VOICE" screen.
KEYER 1st Menu	KEYER-Root or KEYER-SEND	Select whether or not to directly select the "KEYER SEND" screen, skipping the "KEYER" screen.
Speaker Out	OFF or ON	Selects to mute the speaker output.
MIC AF Out	OFF or ON	Selects to output the received audio from the [MIC] connector.
RC MIC		
[F-1]	---, P.AMP/ATT, AGC, NB, NR, NOTCH, RIT, AUTOTUNE/RX>CS, TS, MPAD, M-CLR, BANK, SPLIT , A/B, DUP, TONE/DSQL, COMP, TBW, METER, DR, FROM/TO (DR), SCAN, Voice TX (T1)	The functions listed to the left can be set to [F-1] of the optional HM-151 REMOTE CONTROL MIC.
[F-2]	---, P.AMP/ATT, AGC, NB, NR, NOTCH, RIT, AUTOTUNE/RX>CS, TS, MPAD, M-CLR, BANK, SPLIT , A/B , DUP, TONE/DSQL, COMP, TBW, METER, DR, FROM/TO (DR), SCAN, Voice TX (T1)	The functions listed to the left can be set to [F-2] of the optional HM-151 REMOTE CONTROL MIC.
Mode Select	<input type="checkbox"/> SSB, <input type="checkbox"/> CW, <input type="checkbox"/> RTTY, <input type="checkbox"/> AM, <input type="checkbox"/> FM, <input type="checkbox"/> WFM, <input type="checkbox"/> DV (All boxes are checked.)	Disables the mode selection of the optional HM-151 REMOTE CONTROL MIC, to simplify operation.
Power OFF (With No Controller)	OFF or ON	Selects whether or not to automatically turn OFF the transceiver when the controller is disconnected from the transceiver.
REF Adjust	0 %~100 %	Sets a number to adjust for a zero beat with a standard signal such as WWV or WWVH, for frequency calibration.

Set mode items and Default settings (Continued)

/// **NOTE:** The default settings shown below in bold are for the USA version.
 /// The default settings may differ, depending on your transceiver version.

Tone Control		In this item, set the RX/TX tone control options.	
RX			
SSB			
RX HPF/LPF	---- - ----, 100~2000 – 500~2400	Sets the high-pass filter or low-pass filter of the receive audio.	
RX Bass	-5~ 0 ~+5	Sets the bass level of the receive audio.	
RX Treble	-5~ 0 ~+5	Sets the treble level of the receive audio.	
AM			
RX HPF/LPF	---- - ----, 100~2000 – 500~2400	Sets the high-pass filter or low-pass filter of the receive audio.	
RX Bass	-5~ 0 ~+5	Sets the bass level of the receive audio.	
RX Treble	-5~ 0 ~+5	Sets the treble level of the receive audio.	
FM			
RX HPF/LPF	---- - ----, 100~2000 – 500~2400	Sets the high-pass filter or low-pass filter of the receive audio.	
RX Bass	-5~ 0 ~+5	Sets the bass level of the receive audio.	
RX Treble	-5~ 0 ~+5	Sets the treble level of the receive audio.	
DV			
RX HPF/LPF	---- - ----, 100~2000 – 500~2400	Sets the high-pass filter or low-pass filter of the receive audio.	
RX Bass	-5~ 0 ~+5	Sets the bass level of the receive audio.	
RX Treble	-5~ 0 ~+5	Sets the treble level of the receive audio.	
WFM			
RX Bass	-5~ 0 ~+5	Sets the bass level of the receive audio.	
RX Treble	-5~ 0 ~+5	Sets the treble level of the receive audio.	
CW			
RX HPF/LPF	---- - ----, 100~2000 – 500~2400	Sets the high-pass filter or low-pass filter of the receive audio.	
RTTY			
RX HPF/LPF	---- - ----, 100~2000 – 500~2400	Sets the high-pass filter or low-pass filter of the receive audio.	
TX			
SSB			
TX Bass	-5~ 0 ~+5	Sets the bass level of the transmit audio.	
TX Treble	-5~ 0 ~+5	Sets the treble level of the transmit audio.	
TBW (WIDE)	100 , 200, 300, 500 – 2500, 2700, 2800, 2900	Sets the lower and higher cut-off frequencies to change the transmission passband width for the wide setting.	
TBW (MID)	100, 200, 300 , 500 – 2500, 2700 , 2800, 2900	Sets the lower and higher cut-off frequencies to change the transmission passband width for the mid setting.	
TBW (NAR)	100, 200, 300, 500 – 2500 , 2700, 2800, 2900	Sets the lower and higher cut-off frequencies to change the transmission passband width for the narrow setting.	
AM			
TX Bass	-5~ 0 ~+5	Sets the bass level of the transmit audio.	
TX Treble	-5~ 0 ~+5	Sets the treble level of the transmit audio.	
FM			
TX Bass	-5~ 0 ~+5	Sets the bass level of the transmit audio.	
TX Treble	-5~ 0 ~+5	Sets the treble level of the transmit audio.	
DV			
TX Bass	-5~ 0 ~+5	Sets the bass level of the transmit audio.	
TX Treble	-5~ 0 ~+5	Sets the treble level of the transmit audio.	

Set mode items and Default settings (Continued)

/// **NOTE:** The default settings shown below in bold are for the USA version.
 /// The default settings may differ, depending on your transceiver version.

Connectors		
In this item, set the external connector's options.		
USB Audio SQL	OFF (OPEN) or ON	Selects whether or not to output the audio from the [USB] connector, according to the squelch state (open or closed).
ACC/USB Output Select	AF or IF	Sets the [USB] connector and the [ACC] socket usage to received audio output or the IF output for DRM (Digital Radio Mondiale).
ACC/USB AF Level	0 %~ 50 %~100 %	Sets the audio output level at the [ACC] socket and the [USB] connector.
ACC/USB IF Level	0 %~ 50 %~100 %	Sets the IF output level at the [ACC] socket and the [USB] connector.
ACC MOD Level	0 %~ 50 %~100 %	Sets the input modulation level at the [ACC] socket.
DATA MOD Level	0 %~ 50 %~100 %	Sets the input modulation level at the [DATA] jack.
USB MOD Level	0 %~ 50 %~100 %	Sets the input modulation level at the [USB] connector.
DATA OFF MOD	MIC, ACC, MIC,ACC or USB	Selects the connector(s) for the desired modulation to input when the data mode is not used.
DATA MOD	MIC, ACC , MIC,ACC or USB	Selects the connector(s) for the desired modulation to input when the data mode is used.
External Keypad		
VOICE	OFF or ON	Selects whether or not to transmit voice memory contents using the external keypad.
KEYER	OFF or ON	Selects whether or not to transmit keyer memory contents using the external keypad.
RTTY	OFF or ON	Selects whether or not to transmit RTTY memory contents using the external keypad.
CI-V		
CI-V Baud Rate	300, 1200, 4800, 9600, 19200 or Auto	Sets the CI-V code transfer speed.
CI-V Address	01h~ 88h ~DFh	Sets the transceiver's unique CI-V hexadecimal address code.
CI-V Transceive	OFF or ON	Turns the CI-V Transceive function ON or OFF.
CI-V Output (for ANT)	OFF or ON	Antenna controller Status data output setting.
USB2/DATA1 Function		
USB2 Function	OFF , RTTY Decode or DV Data	Selects the use of the COM port (USB2).
DATA1 Function	OFF, RTTY Decode, DV Data or GPS	Select the use of the [DATA1] jack.
GPS Out	OFF or DATA1 → USB2	Selects whether or not to output the data to the COM port (USB2) when data is input from a GPS receiver through the [DATA1] jack.
DV Data/GPS Out Baud	4800 or 9600	Sets the DV or GPS data transfer speed
RTTY Decode Baud	300, 1200, 4800, 9600 or 19200	Sets the RTTY decode monitor speed.
VSEND Select	OFF, UHF or VHF/UHF	Selects the band to use for the [ACC] socket's pin 7 (VSEND usage).
9600bps Mode	OFF or ON	Selects whether or not to allow data transmission at 9600 bps.

Set mode items and Default settings (Continued)

/// **NOTE:** The default settings shown below in bold are for the USA version.
 /// The default settings may differ, depending on your transceiver version.

Display		
In this item, set the transceiver's display options.		
LCD Contrast	0%~ 50% ~100%	Sets the contrast level of the LCD.
LCD Backlight	0%~ 50% ~100%	Sets the backlight level of the LCD.
Key Backlight	0%~ 50% ~100%	Sets the backlight level of the key.
Meter Peak Hold	OFF or ON	Turns the Meter Peak Hold function ON or OFF.
BW Popup (PBT)	OFF or ON	Selects whether or not to display the PBT shifting value and the passband width while rotating the TWIN-PBT control.
BW Popup (FIL)	OFF or ON	Selects whether or not to display the IF filter width and shifting value when the IF filter is switched.
RX Call Sign Display	OFF, Auto or Auto (RX Hold)	Selects whether or not to display the call sign of the caller station when a call is received.
RX Message Display	OFF or Auto	Selects whether or not to display and scroll a received message.
Reply Position Display	OFF or ON	Selects whether or not to display the caller's position data when the data is included in the Auto Reply signal.
TX Call Sign Display	OFF, Your Call Sign or My Call Sign	Selects whether or not to display My or Your call sign while transmitting.
Scroll Speed	Slow or Fast	Sets the scrolling speed of the message, call sign, or other text, that are displayed on the transceiver's LCD.
VOICE TX Name Display	OFF or ON	Selects whether or not to display the voice TX memory name on the "VOICE TX" screen.
KEYER Memory Display	OFF or ON	Selects whether or not to display the keyer memory contents on the "KEYER SEND" screen.
Opening Message	OFF or ON	Selects whether or not to display the opening message at power ON.
Power ON Check	OFF or ON	Selects whether or not to display the RF Power, RIT, Auto Power OFF condition at power ON.
Display Language	English or Japanese	Sets the screen display language type in the DR mode or Menu mode. When the System Language is "English," this item disappears.
System Language	English or Japanese	Sets the system language of the transceiver.
Time Set		
In this item, set the time options.		
Date/Time		
DATE	2000/01/01 ~2099/12/31	Sets the date.
TIME	0:00 ~23:59	Sets the time.
GPS Time Correct	OFF or Auto	Selects whether or not to automatically correct the time data by a received GPS sentence.
UTC Offset	-14:00~ ±0:00 ~+14:00	Sets the time difference between UTC (Universal Time Coordinated) and the local time.
Clock Display	Local or UTC	Sets the clock display mode.
Auto Power OFF	OFF , 30min, 60min, 90min or 120min	Sets to automatically turn OFF the transceiver power after no operation is made during this set period.

Set mode items and Default settings (Continued)

/// **NOTE:** The default settings shown below in bold are for the USA version.
 /// The default settings may differ, depending on your transceiver version.

Others	In this item, set other options.
Information	
Version	Shows the transceiver's firmware version number.
Clone	
Clone Mode	Reads or writes the CS-7100 data to or from the PC, and/or receives data from a Master transceiver.
Clone Master Mode	Writes your IC-7100 (Master) data to another IC-7100 (Sub).
Touch Screen Calibration	Adjusts the touch screen.
Reset	
Partial Reset	Returns all settings to their default values, without clearing the memory contents, call sign memories or repeater lists.
All Reset	Clears all programming and memories, and return all settings to their default values.

Section 7 **INFORMATION**

Installation notes	7-2
About CE and DOC.....	7-3
Disposal.....	7-3

Section 1 PANEL DESCRIPTION

Section 2 INSTALLATION AND CONNECTIONS

Section 3 BASIC OPERATION

Section 4 D-STAR INTRODUCTION

Section 5 D-STAR OPERATION <BASIC>

Section 6 SET MODE

Section 7 INFORMATION

Installation notes

For amateur base station installations it is recommended that the forward clearance in front of the antenna array is calculated relative to the EIRP (Effective Isotropic Radiated Power). The clearance height below the antenna array can be determined in most cases from the RF power at the antenna input terminals.

As different exposure limits have been recommended for different frequencies, a relative table shows a guideline for installation considerations.

Below 30 MHz, the recommended limits are specified in terms of V/m or A/m fields as they are likely to fall within the near-field region. Similarly, the antennas may be physically short in terms of electrical length and that the installation will require some antenna matching device which can create local, high intensity magnetic fields. Analysis of such MF installations is best considered in association with published guidance notes such as the FCC OET Bulletin 65 Edition 97-01 and its annexes relative to amateur transmitter installations.

The EC recommended limits are almost identical to the FCC specified 'uncontrolled' limits and tables exist that show pre-calculated safe distances for different antenna types for different frequency bands. Further information can be found at <http://www.arrl.org/>.

• Typical amateur radio installation

Exposure distance assumes that the predominant radiation pattern is forward and that radiation vertically downwards is at unity gain (sidelobe suppression is equal to main lobe gain). This is true of almost every gain antenna today. Exposed persons are assumed to be beneath the antenna array and have a typical height of 1.8 m.

The figures assume the worst case emission of a constant carrier.

For the bands 10 MHz and higher the following power density limits have been recommended:

10–400 MHz	2 W/sq m
435 MHz	2.2 W/sq m

EIRP clearance heights by frequency band

Watts	10–2 m	70 cm	23 cm	13 cm and above
1	2.1 m	2 m	2 m	2 m
10	2.8 m	2.7 m	2.5 m	2.3 m
25	3.4 m	3.3 m	2.7 m	2.5 m
100	5 m	4.7 m	3.6 m	3.2 m
1000	12 m	11.5 m	7.3 m	6.3 m

Forward clearance, EIRP by frequency band

Watts	10–2 m	70 cm	23 cm	13 cm and above
100	2 m	2 m	1.1 m	0.7 m
1,000	6.5 m	6 m	3.5 m	3 m
10,000	20 m	18 m	11 m	7 m
100,000	65 m	60 m	35 m	29 m

In all cases any possible risk depends on the transmitter being activated for long periods. (actual recommendation limits are specified as an average during 6 minutes) Normally the transmitter is not active for long periods of time. Some radio licenses will require that a timer circuit automatically cuts off the transmitter after 1–2 minutes etc.

Similarly some modes of transmission, SSB, CW, AM etc. have a lower 'average' output power and the assessed risk is even lower.

About CE and DOC

CE Hereby, Icom Inc. declares that the versions of IC-7100 which have the “CE” symbol on the product, comply with the essential requirements of the Radio Equipment Directive, 2014/53/EU, and the restriction of the use of certain hazardous substances in electrical and electronic equipment Directive, 2011/65/EU. The full text of the EU declaration of conformity is available at the following internet address:
<https://www.icomjapan.com/support/>

Disposal



The crossed-out wheeled-bin symbol on your product, literature, or packaging reminds you that in the European Union, all electrical and electronic products, batteries, and accumulators (rechargeable batteries) must be taken to designated collection locations at the end of their working life. Do not dispose of these products as unsorted municipal waste. Dispose of them according to the laws in your area.

Count on us!

