



INSTRUCTION MANUAL

COMMUNICATIONS RECEIVER

IC-R8600



PREFACE

Thank you for choosing this Icom product. The IC-R8600 COMMUNICATIONS RECEIVER is a wide band receiver which designed to cover the 10 kHz to 3 GHz range with Icom's state of the SDR technology. With proper care, this product should provide you with years of trouble-free operation. Many hours of research and development went into the design of your IC-R8600.

IMPORTANT

READ ALL INSTRUCTIONS carefully completely before using the receiver.

SAVE THIS INSTRUCTION MANUAL— This instruction manual contains operating instructions for the IC-R8600.



Hereby, Icom Inc. declares that the versions of IC-R8600 which have the "CE" symbol on the product, comply with the essential requirements of the Radio Equipment Directive, 2014/53/EU, and the restriction of the use of certain hazardous substances in electrical and electronic equipment Directive, 2011/65/EU. The full text of the EU declaration of conformity is available at the following internet address: <http://www.icom.co.jp/world/support/>

EXPLICIT DEFINITIONS

WORD	DEFINITION
⚠ DANGER!	Personal death, serious injury or an explosion may occur.
⚠ WARNING!	Personal injury, fire hazard or electric shock may occur.
CAUTION	Equipment damage may occur.
NOTE	Recommended for optimum use. No risk of personal injury, fire or electric shock.

TRADEMARKS

Icom, Icom Inc. and the Icom logo are registered trademarks of Icom Incorporated (Japan) in Japan, the United States, the United Kingdom, Germany, France, Spain, Russia, Australia, New Zealand and/or other countries.

NXDN is a trademark of Icom Incorporated and JVC KENWOOD Corporation.

dPMR and the dPMR logo are trademarks of the dPMR MoU Association.

Microsoft, Windows and Windows Vista are registered trademarks of Microsoft Corporation in the United States and/or other countries.

All other products or brands are registered trademarks or trademarks of their respective holders.

This product includes RTOS "RTX" software, and is licensed according to the software license.
This product includes "zlib" open source software, and is licensed according to the open source software license.
This product includes "libpng" open source software, and is licensed according to the open source software license.
Refer to page I for information on the open source software being used by this product.

FEATURES

- **Covers 10 kHz to 3 GHz for wide band reception**
- **Receives various digital modes such as D-STAR, P25 (Phase 1), NXDN, dPMR and DCR (Digital Convenience Radio)**
- **12 kHz IF output port for DRM broadcast**
- **Hi-speed Real-Time Spectrum Scope**
- **A 4.3 inch touch panel color display**
- **Multi-function dials for easy settings**
- **An SD card slot**
You can record the received audio, save the receiver settings, decoded FSK logs and so on, onto an SD card (user supplied).
- **“IP+” Function**
The IP Plus function improves 3rd order intercept point (IP3) performance.
- **I/Q baseband signal output port**
- **Optional external speaker (with integrated power supply)**

SUPPLIED ACCESSORIES

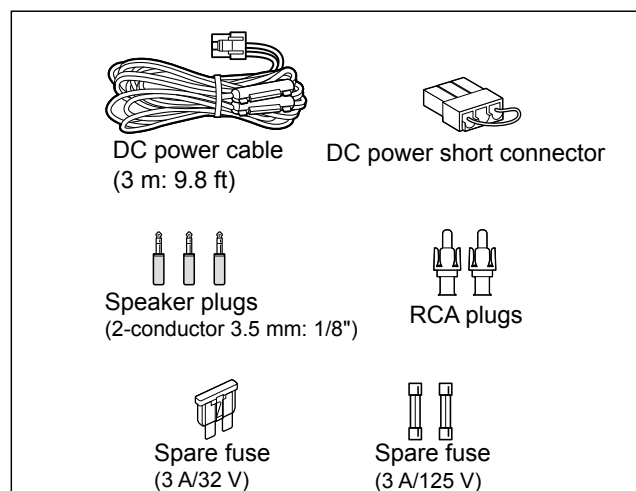

① Different types of accessories may be supplied, or may not be supplied depending on the receiver version.

ABOUT THE SDR WIDEBAND RECEIVER CIRCUITS

While ordinary wide band receivers need to have dedicated demodulator circuits for each receive mode, the IC-R8600 utilizes advanced digital processes that demodulate the incoming signals.

The IF signal is sent to the A/D converter, resulting in digital signal, then is processed by a high-speed FPGA and DSP to be restored to an analog audio signal.

The received signal is processed to be demodulated according to the receive mode, including not only conventional analog communications in CW, AM, SSB, FM, WFM and FSK, but also advanced digital communications in D-STAR, P25, NXDN, dPMR and DCR. This was achieved by using Software Defined Radio (SDR) technology.

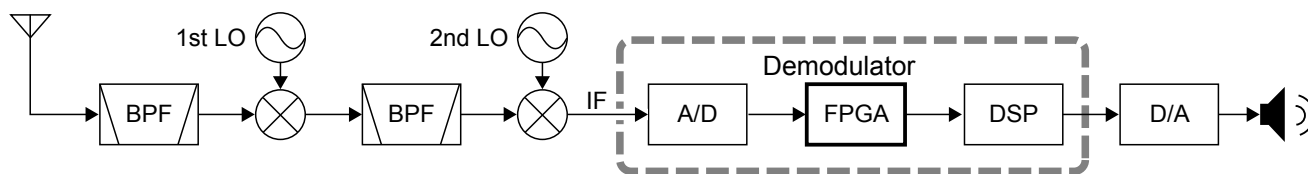

Double conversion super heterodyne receiver (Example for 30.000000 MHz ~ 1099.999999 MHz)

VOICE CODING TECHNOLOGY

The AMBE+2™ voice coding Technology embodied in this product is protected by intellectual property rights including patent rights, copyrights and trade secrets of Digital Voice Systems, Inc. This voice coding Technology is licensed solely for use within this Communications Equipment. The user of this Technology is explicitly prohibited from attempting to extract, remove, decompile, reverse engineer, or disassemble the Object Code, or in any other way convert the Object Code into a human-readable form. U.S. Patent Nos.

#5,870,405, #5,826,222, #5,754,974, #5,701,390, #5,715,365, #5,649,050, #5,630,011, #5,581,656, #5,517,511, #5,491,772, #5,247,579, #5,226,084 and #5,195,166.

FCC INFORMATION

• FOR CLASS B UNINTENTIONAL RADIATORS:

This equipment has been tested and found to comply with the limits for a Class B digital device, pursuant to part 15 of the FCC Rules. These limits are designed to provide reasonable protection against harmful interference in a residential installation. This equipment generates, uses and can radiate radio frequency energy and, if not installed and used in accordance with the instructions, may cause harmful interference to radio communications. However, there is no guarantee that interference will not occur in a particular installation. If this equipment does cause harmful interference to radio or television reception, which can be determined by turning the equipment off and on, the user is encouraged to try to correct the interference by one or more of the following measures:

- Reorient or relocate the receiving antenna.
- Increase the separation between the equipment and receiver.
- Connect the equipment into an outlet on a circuit different from that to which the receiver is connected.
- Consult the dealer or an experienced radio/TV technician for help.

WARNING: MODIFICATION OF THIS DEVICE TO RECEIVE CELLULAR RADIOTELEPHONE SERVICE SIGNALS IS PROHIBITED UNDER FCC RULES AND FEDERAL LAW.

CAUTION: Changes or modifications to this device, not expressly approved by Icom Inc., could void your authority to operate this device under FCC regulations.

DISPOSAL



The crossed-out wheeled-bin symbol on your product, literature, or packaging reminds you that in the European Union, all electrical and electronic products, batteries, and accumulators (rechargeable batteries) must be taken to designated collection locations at the end of their working life. Do not dispose of these products as unsorted municipal waste. Dispose of them according to the laws in your area.

Icom is not responsible for the destruction, damage to, or performance of any Icom or non-Icom equipment, if the malfunction is because of:

- Force majeure, including, but not limited to, fires, earthquakes, storms, floods, lightning, or other natural disasters, disturbances, riots, war, or radioactive contamination.
- The use of Icom receivers with any equipment that is not manufactured or approved by Icom.

ABOUT THE INSTRUCTIONS

This manual is described in the following manner.

“ ” (Quotation marks):

Used to indicate icons, setting items, and screen titles displayed on the screen.

The screen titles are also indicated in uppercase letters. (Example: FUNCTION screen)

[] (brackets):

Used to indicate keys.

Routes to the set modes and setting screens

Routes to the Set mode, setting screen and the setting items are described in the following manner.

MENU » **SET > Time Set > Date**

Instruction example

◇ Setting date

1. Open the Date screen.

MENU » **SET > Time Set > Date/Time > Date**

2. Touch [+] or [-] to set the date.
3. Touch [SET] to store the entry.

◇ About the touch operation

In the manual, the touch operation is described as shown below.



Touch

If the display is touched briefly, one short beep sounds.



Touch for 1 second

If the display is touched for 1 second, one short and one long beep sound.

◇ Touch screen precautions

- The touch screen may not properly work when the LCD protection film or sheet is attached.
- Touching the screen with your finger nails, sharp topped object and so on, or touching the screen hard may damage it.
- Tablet PC's operations such as flick, pinch in and pinch out cannot be performed on this touch screen.

◇ Touch screen maintenance

- If the touch screen becomes dusty or dirty, wipe it clean with a soft, dry cloth.
- When you wipe the touch screen, be careful not to push it too hard or scratch it with your finger nails. Otherwise you may damage the screen.

Detailed instruction

1. Push **MENU**.

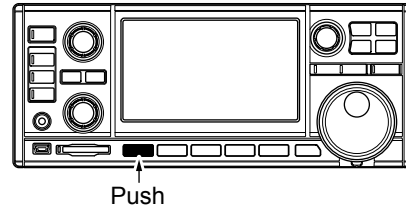

- The MENU screen opens.

2. Touch [SET].



- The SET screen opens.

3. Rotate **DIAL C** to select "Time Set," and then push **DIAL C**.

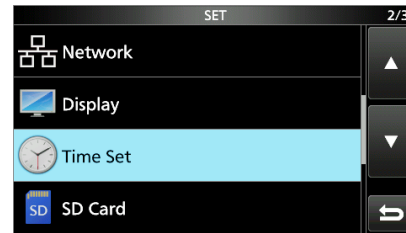

4. Rotate **DIAL C** to select "Date," then push **DIAL C**.

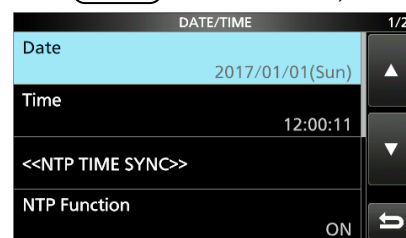

5. Touch [+] or [-] to set the date.
6. Touch [SET] to save the entry.

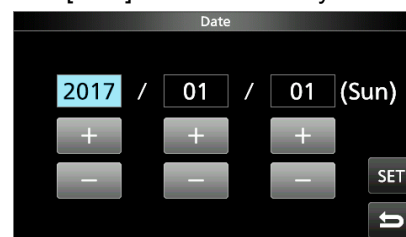

TABLE OF CONTENTS

PREFACE.....	i	◇About the Tuning Step (TS) function.....	3-2
IMPORTANT.....	i	◇About the Programmable Tuning Step function.....	3-3
TRADEMARKS.....	i	◇About the Auto Tuning Step function.....	3-3
EXPLICIT DEFINITIONS.....	i	Selecting the antenna.....	3-3
FEATURES.....	ii	Dial/Panel Lock function.....	3-3
ABOUT THE SDR WIDEBAND RECEIVER CIRCUITS.....	ii	◇Dial Lock function.....	3-3
VOICE CODING TECHNOLOGY.....	ii	◇Panel Lock function.....	3-3
SUPPLIED ACCESSORIES.....	ii	Adjusting Backlight dimmer.....	3-4
FCC INFORMATION.....	iii	Fine tuning.....	3-4
ABOUT THE INSTRUCTIONS.....	iv	◇When receiving FM, WFM or DIGITAL signal.....	3-4
◇About the touch operation.....	iv	◇When receiving FSK signal.....	3-4
◇Touch screen precautions.....	iv	Selecting meter display.....	3-4
◇Touch screen maintenance.....	iv	◇Meter display types.....	3-4
TABLE OF CONTENTS.....	v		
PRECAUTIONS.....	viii		
1 PANEL DESCRIPTION.....	1-1	4 SCOPE OPERATION.....	4-1
Front panel.....	1-1	Spectrum scope screen.....	4-1
Rear panel.....	1-3	◇RX Marker.....	4-1
Touch panel display.....	1-4	◇Using the Spectrum Scope.....	4-1
◇MULTI DIAL MENU (DIAL A).....	1-6	◇Setting the span.....	4-2
◇MULTI DIAL MENU (DIAL B).....	1-6	◇Setting the range.....	4-2
◇MULTI DIAL MENU (DIAL C).....	1-6	◇Searching for the peak signal.....	4-3
◇MENU screen.....	1-6	◇Touch screen operation.....	4-3
◇QUICK MENU.....	1-6	◇Mini scope screen.....	4-3
◇FUNCTION screen.....	1-7	◇Adjusting the Reference level.....	4-4
◇FUNCTION items.....	1-7	◇Sweep speed.....	4-4
Keyboard entering and editing.....	1-7	◇Scope set screen.....	4-5
◇Entering and editing characters.....	1-7		
◇Keyboard types.....	1-8	5 OTHER FUNCTIONS.....	5-1
◇Entry example.....	1-8	About the Function screen.....	5-1
2 INSTALLATION AND CONNECTIONS.....	2-1	Preamplifier.....	5-1
Selecting a location.....	2-1	Attenuator.....	5-1
Heat dissipation.....	2-1	Selecting the antenna.....	5-1
For desktop use.....	2-1	AGC function control.....	5-1
Grounding.....	2-1	IP Plus function.....	5-2
Connecting a DC power supply.....	2-1	Notch Filter.....	5-2
◇Power supply.....	2-1	◇Setting the notching width and frequency.....	5-2
◇Turning the receiver's power ON or OFF.....	2-1	Using the Digital Twin PBT.....	5-2
Connecting an antenna.....	2-2	Selecting the digital IF filter.....	5-3
FSK (RTTY) connections.....	2-2	◇Adjusting the passband width.....	5-3
External device connection.....	2-3	◇Selecting the filter shape.....	5-3
3 BASIC OPERATION.....	3-1	Noise Blanker (NB).....	5-4
Adjusting the volume level.....	3-1	Noise Reduction.....	5-4
RF gain/SQL level/Audio tone.....	3-1	Duplex operation.....	5-4
◇Noise squelch.....	3-1	AFC function.....	5-5
◇S-meter squelch.....	3-1	Receiving in the CW mode.....	5-5
◇RF gain.....	3-1	◇Setting the CW pitch control.....	5-5
Monitor function.....	3-1	◇About the CW Reverse mode.....	5-5
About the VFO and Memory modes.....	3-1	Receiving FSK (RTTY) signal.....	5-5
Selecting the receiving mode.....	3-1	◇Decoded FSK data display.....	5-5
Selecting the receiving mode (continued).....	3-2	◇Decoding FSK signal.....	5-5
Setting the frequency.....	3-2	◇Turning ON the FSK log.....	5-6
◇Directly entering a frequency.....	3-2	◇Viewing the FSK log contents.....	5-7
Changing the Tuning Step.....	3-2	◇Twin Peak Filter.....	5-7
		◇FSK tone and shift setting.....	5-7
		◇About the FSK DECODE SET screen.....	5-8
		Tone squelch function.....	5-9
		D.SQL (Digital Squelch) function.....	5-9

◇ Digital Code Squelch.....	5-9		
◇ Network Access Code (NAC).....	5-9		
◇ Group Code (COM ID) and CC.....	5-10		
◇ Radio Access Number (RAN).....	5-10		
◇ User Code (UC).....	5-10		
Descrambler function	5-10		
Decryption function.....	5-10		
Receive history log	5-11		
Screen Capture function.....	5-11		
◇ Capturing a screen.....	5-11		
◇ Viewing the captured screen.....	5-11		
6 RECORDING AND PLAYING BACK.....	6-1		
Recording	6-1		
◇ Quick recording	6-1		
◇ Normal recording.....	6-1		
Playing back.....	6-1		
Operation while playing back	6-2		
Playing back on a PC.....	6-2		
Checking the file information.....	6-3		
Deleting a file.....	6-3		
Deleting a folder	6-4		
PLAYER SET screen.....	6-4		
RECORDER SET screen	6-4		
7 USING AN SD CARD.....	7-1		
About the SD card	7-1		
◇ SD card's folder contents	7-1		
Saving data onto the SD card	7-1		
Inserting or removing the SD card.....	7-1		
◇ Inserting.....	7-1		
◇ Removing (While the receiver is OFF)	7-1		
◇ Removing (While the receiver is ON).....	7-1		
Formatting an SD card	7-2		
Saving in the old format.....	7-2		
Saving the setting data.....	7-2		
Loading the data files	7-3		
Deleting a data file.....	7-3		
Checking SD card information.....	7-3		
8 Memory channels	8-1		
Selecting channel group.....	8-1		
◇ Selecting with ▲GRP/▼GRP	8-1		
◇ Selecting on the [GROUP SELECT] screen.....	8-1		
Selecting a memory channel	8-2		
◇ Selecting with (DIAL C)	8-2		
◇ Selecting with (MAIN DIAL)	8-2		
◇ Selecting using the keypad	8-2		
Writing a memory channel	8-2		
Copying the Memory contents.....	8-3		
Inserting a blank channel	8-3		
Clearing a memory channel	8-3		
Entering a group/memory name.....	8-4		
◇ Entering a group name.....	8-4		
◇ Entering a memory name	8-4		
About the MEMORY screen	8-5		
9 SCANS.....	9-1		
Scan types.....	9-1		
Basic scanning	9-1		
◇ VFO scan and Memory scan.....	9-1		
◇ Priority scan.....	9-1		
Adjusting the scan speed	9-1		
Setting the Scan Resume function	9-2		
◇ Setting the scan pause timer.....	9-2		
◇ Setting the Scan Resume function.....	9-2		
Setting the priority interval.....	9-2		
Priority scan.....	9-2		
◇ Priority scan operation.....	9-2		
◇ Monitoring the Priority channel.....	9-2		
Scan Setting screen	9-3		
Programmed scan and Fine Programmed scan	9-4		
◇ Programmed scan operation	9-4		
◇ Fine Programmed scan operation	9-4		
ΔF scan	9-5		
◇ ΔF scan operation.....	9-5		
◇ Fine ΔF scan operation.....	9-5		
Auto Memory Write scan	9-6		
◇ Auto Memory Write scan operation	9-6		
Memory scan and Select Memory scan	9-7		
◇ Memory scan operation.....	9-7		
◇ Select Memory scan operation.....	9-7		
◇ Setting Select Memory channels.....	9-8		
◇ Canceling the Select Memory channel settings.....	9-8		
Mode select memory scan	9-9		
◇ Setting the receive mode	9-9		
Setting the skip frequency	9-9		
◇ Setting the skip frequency.....	9-9		
◇ Canceling the skip frequency	9-9		
Setting the Temporary Skip	9-10		
Skip channel for memory scan	9-10		
Voice Squelch Control function	9-11		
Tone scan operation	9-11		
10 CLOCK AND TIMER.....	10-1		
Setting the Time and Date	10-1		
◇ Setting date	10-1		
◇ Setting time	10-1		
NTP Time Server.....	10-1		
◇ Execute the time synchronization	10-1		
◇ Setting the NTP Server address.....	10-1		
Timer	10-2		
◇ Setting the Sleep timer.....	10-2		
◇ Setting the Daily timer	10-2		
Timer (continued)	10-3		
◇ Timer setting items.....	10-3		
◇ About the Timer recording.....	10-3		

11 SET MODE.....	11-1
Set mode description.....	11-1
◇ Entering the Set mode	11-1
Tone Control.....	11-2
Function.....	11-2
Digital Set.....	11-4
Connectors	11-5
Network	11-7
Display.....	11-9
Time Set.....	11-10
SD Card.....	11-10
Others.....	11-10
12 MAINTENANCE.....	12-1
Cleaning	12-1
Replacing fuse.....	12-1
◇ DC power cable fuses	12-1
◇ Circuitry fuse	12-1
Resetting	12-2
◇ Partial reset	12-2
◇ All reset	12-2
Touch screen calibration.....	12-3
Troubleshooting.....	12-4
13 UPDATING THE FIRMWARE	13-1
General.....	13-1
◇ About updating the firmware	13-1
◇ Checking the firmware version.....	13-1
Preparation.....	13-1
◇ Downloading the firmware file	13-1
◇ Unzipping the firmware folder.....	13-1
Updating the firmware	13-2
14 SPECIFICATIONS	14-1
◇ General.....	14-1
◇ Receiver	14-1
15 OPTIONS	15-1
Options	15-1
Attaching the MB-123.....	15-1
16 CONNECTOR INFORMATION	16-1
ABOUT THE LICENSES.....	I
INDEX.....	II

PRECAUTIONS

⚠ **DANGER! NEVER** operate the receiver near unshielded electrical blasting caps or in an explosive atmosphere. This could cause an explosion and death.

⚠ **WARNING! NEVER** operate the receiver with a headset or other audio accessories at high volume levels. If you experience a ringing in your ears, reduce the volume or discontinue use.

⚠ **WARNING! NEVER** apply AC power to the [DC13.8V] socket on the receiver rear panel. This could cause a fire or damage the receiver.

⚠ **WARNING! NEVER** apply more than 16 V DC to the [DC13.8V] socket on the receiver rear panel. This could cause a fire or damage the receiver.

⚠ **WARNING! NEVER** reverse the DC power cable polarity. This could cause a fire or damage the receiver.

⚠ **WARNING! NEVER** remove the fuse holder on the DC power cable. Excessive current caused by a short could cause a fire or damage the receiver.

⚠ **WARNING! NEVER** let metal, wire or other objects contact the inside of the receiver, or make incorrect contact with connectors on the rear panel. This could cause an electric shock or damage the receiver.

⚠ **WARNING! NEVER** operate or touch the receiver with wet hands. This could cause an electric shock or damage to the receiver.

⚠ **WARNING!** Immediately turn OFF the receiver power and remove the power cable from the receiver if it emits an abnormal odor, sound or smoke. Contact your Icom dealer or distributor for advice.

⚠ **WARNING! NEVER** put the receiver on an unstable place where the receiver may suddenly move or fall. This could cause an injury or damage the receiver.

⚠ **WARNING! NEVER** operate the receiver during a lightning storm. It may result in an electric shock, cause a fire or damage the receiver. Always disconnect the power source and antenna before a storm.

CAUTION: NEVER expose the receiver to rain, snow or any liquids.

CAUTION: NEVER change the internal settings of the receiver. This could reduce receiver performance and/or damage to the receiver. The receiver warranty does not cover any problems caused by unauthorized internal adjustments.

CAUTION: NEVER install or place the receiver in a place without adequate ventilation.

CAUTION: NEVER use harsh solvents such as Benzine or alcohol when cleaning, as they will damage the receiver surfaces.

CAUTION: NEVER leave the receiver in areas with temperatures below -10°C ($+14^{\circ}\text{F}$) or above $+60^{\circ}\text{C}$ ($+140^{\circ}\text{F}$).

CAUTION: NEVER place the receiver in excessively dusty environments. This could damage the receiver.

DO NOT place the receiver against walls or put anything on top of the receiver. This may overheat the receiver.

BE CAREFUL! The receiver will become hot when operating the receiver continuously for long periods of time.

NEVER leave the receiver in an insecure place to avoid use by unauthorized persons.

Turn OFF the receiver's power and/or disconnect the DC power cable when you will not use the receiver for long period of time.

The display may have cosmetic imperfections that appear as small dark or light spots. This is not a malfunction or defect, but a normal characteristic of LCDs.

The IC-R8600 may receive its own oscillated frequency, resulting in no reception or only noise reception including on the Spectrum Scope screen, on some frequencies.

Front panel

This section describes the keys, controls and dials that you use to operate the IC-R8600. Refer to the pages posted beside each key, control, or dial for details.

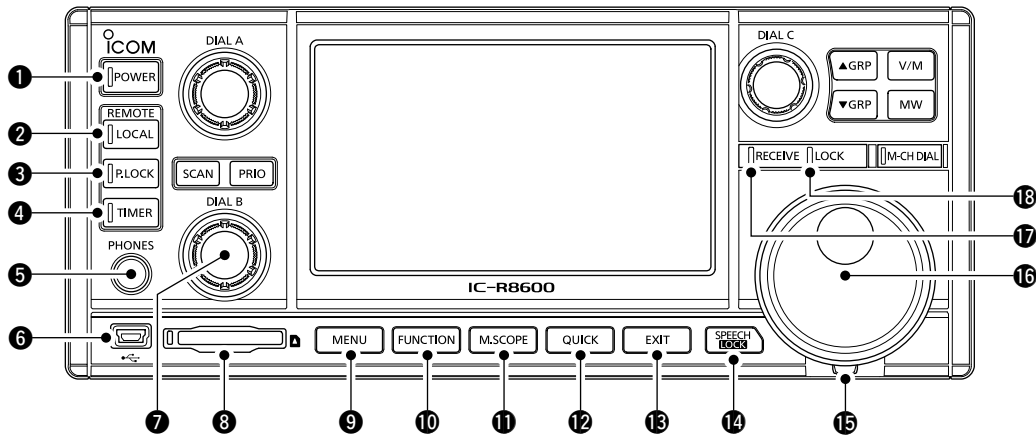

- 1 POWER KEY** **POWER** (p. 2-1)
Turns the receiver ON (lights blue) or OFF.
- 2 LOCAL KEY** (p. 16-2)
Turns OFF the Remote mode.
① In the Remote mode, all the operations on the panel except **LOCAL**, **POWER** and **P.LOCK** are locked.
- 3 PANEL LOCK KEY** **P.LOCK** (p. 3-3)
Locks the controls (lights white) on the front panel.
① Hold down for 1 second to turn OFF the display.
- 4 TIMER KEY** **TIMER** (p. 10-2)
Turns ON (lights orange) or OFF the Timer function.
① Set the current time to use the Timer function. (p. 10-1)
- 5 HEADPHONE JACK** **[PHONES]** (p. 16-2)
Accepts headphones. (3.5 mm: 1/8 in (d))
- 6 [USB] (mini-B type) PORT** (pp. 2-3, 16-1)
Connects to a PC.
• Outputs the decoded FSK (RTTY) or D-STAR data.
• Outputs the demodulated AF signal or 12 kHz IF signal.
• Interface for the optional CS-R8600 or RS-R8600.
• Interface for the remote control by the CI-V command.
- 7 DIAL B** **(DIAL B)** (p. 1-6)
• Rotate to adjust the audio output level.
• Push to display the setting menu, then rotate to adjust the RF gain (sensitivity), squelch threshold levels or audio tone (Treble or Bass).
• Hold down to turn ON the Monitor function (the squelch opens).
- 8 SD CARD SLOT** **[SD CARD]** (pp. 7-1, 7-2)
Accepts an SD card.
- 9 MENU KEY** **MENU** (pp. 1-6, 11-1)
Opens the MENU screens where you can modify the receiver settings and edit memory channels.
- 10 FUNCTION KEY** **FUNCTION** (pp. 1-7, 5-1)
Displays the FUNCTION screen where you can configure various settings.
- 11 MINI SCOPE KEY** **M.SCOPE** (p. 4-3)
• Push to display the Mini Scope.
• Hold down for 1 second to display the Spectrum Scope.
- 12 QUICK KEY** **QUICK** (p. 1-6)
Displays the QUICK MENU.
- 13 EXIT KEY** **EXIT**
Exits a setting screen or returns to the previous screen.
- 14 SPEECH/LOCK KEY** **SPEECH LOCK** (p. 3-3)
• Push to announce the receiving frequency and mode.
• Hold down for 1 second to lock (lights white) **(MAIN DIAL)**.
- 15 TENSION ADJUSTER**
Adjusts the friction of **(MAIN DIAL)** in 3 steps.
- 16 MAIN DIAL** **(MAIN DIAL)**
Changes the operating frequency or setting value.
- 17 RECEIVE INDICATOR**
Lights green while receiving a signal or the squelch (p. 3-1) is opened.
- 18 LOCK INDICATOR** (p. 3-3)
Lights white while the **(MAIN DIAL)** is locked by **SPEECH LOCK**.

Front panel (Continued)

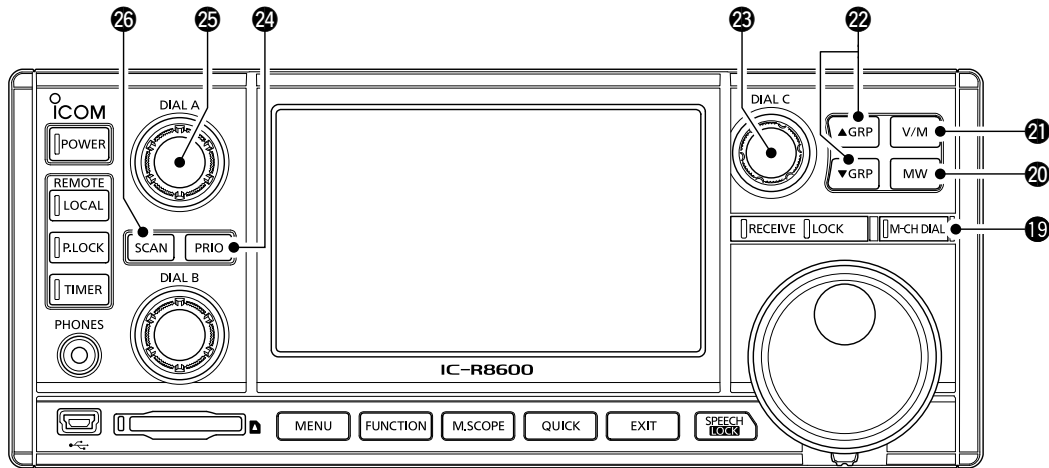
**19 MEMORY CHANNEL DIAL KEY** **M-CH DIAL** (p. 8-2)

Push this key (lights white) then rotate **MAIN DIAL** to change the Memory channel number.

20 MEMORY WRITE KEY **MW** (p. 8-2)

- Push to open the MW MENU screen.
- Hold down for 1 second to write the current receiving contents (frequency, mode, and so on) to a memory channel.

21 VFO/MEMORY KEY **V/M** (p. 3-1)

- Push to toggle between the VFO and Memory modes,
- Hold down for 1 second to copy the selected memory channel contents to the VFO.

22 MEMORY GROUP KEY **▲GRP/▼GRP** (p. 8-1)

Changes the Memory channel group.

23 DIAL C **DIAL C** (p. 1-6)

- Push to display the Multi Dial menu.
- Turn to change the memory channel number.

24 PRIORITY SCAN KEY **PRIORITY** (p. 9-2)

Starts or cancels a Priority scan.

- ① Select a Memory channel before starting a Priority scan.

25 DIAL A **DIAL A** (p. 1-6)

- Push to display the scan setting menu, then rotate to set the Scan speed or Priority scan interval.

26 SCAN KEY **SCAN** (p. 9-1)

- Push to display the SCAN START screen.
- Hold down for 1 second to start a scan (except Priority scan).

Rear panel

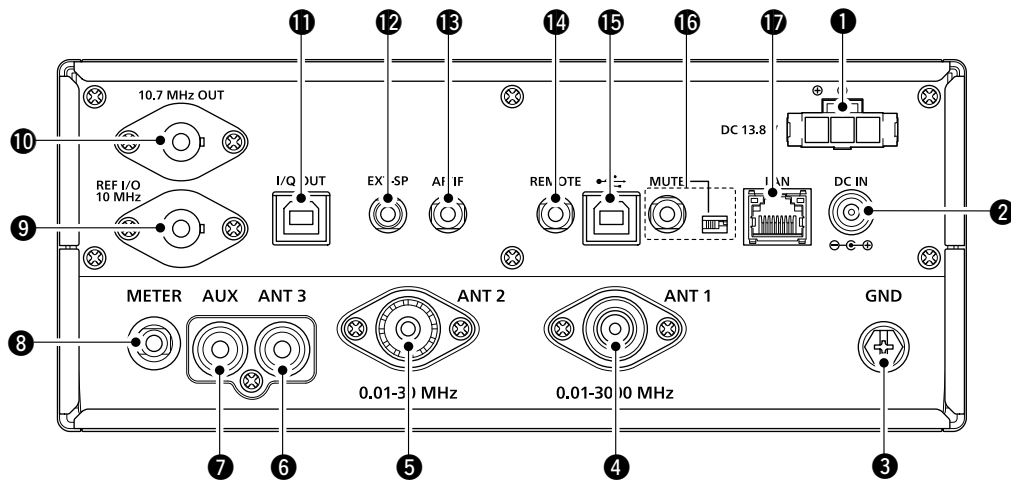

① DC POWER SOCKET [DC 13.8 V] (pp. 2-1, 16-2)

Connects to the supplied DC power cable.

② DC INPUT JACK [DC IN] (pp. 2-1, 16-2)

Connects to the optional SP-39AD (External speaker with built-in power adapter) or AD-55NS (Power adapter).

① Before connecting an SP-39AD or AD-55NS, connect the supplied DC power short connector to [DC 13.8V] (①).

③ GROUND TERMINAL [GND] (p. 2-1)

Connects to ground to prevent electrical shocks and other problems.

④ ANTENNA CONNECTOR [ANT1] (N type) (p. 2-2)

Connects to a 10 kHz ~ 3000 MHz antenna.

⑤ ANTENNA CONNECTOR [ANT2] (SO-239) (p. 2-2)

Connects to a 10 kHz ~ 30 MHz antenna.

⑥ ANTENNA CONNECTOR [ANT3] (RCA) (p. 2-2)

Connects to a 10 kHz ~ 30 MHz antenna.

⑦ AUX JACK [AUX]

A reserved jack. No internal connection.

⑧ EXTERNAL METER JACK [METER] (pp. 2-3, 16-1)

Connects to an external analog RSSI or squelch level meter (user supplied).

⑨ REFERENCE SIGNAL INPUT/OUTPUT CONNECTOR [REF I/O 10MHz] (BNC) (p. 16-1)

Inputs or outputs a 10 MHz reference frequency signal.

⑩ IF SIGNAL OUTPUT CONNECTOR [10.7MHz OUT] (BNC) (p. 16-1)

Outputs a 10.7 MHz IF signal.

⑪ I/Q DATA OUTPUT PORT [I/Q OUT] (pp. 2-3, 16-1)

Outputs I/Q data.

① Connect a USB (1.1/2.0 standard) port (B type).

⑫ EXTERNAL SPEAKER JACK [EXT-SP] (pp. 2-3, 16-2)

Connects to an optional external speaker SP-39AD (External speaker with built-in power adapter).

(3.5 mm: 1/8 in (d))

① Accepts a 4~8 Ω speaker.

⑬ AF/IF OUTPUT JACK [AF/IF] (pp. 2-3, 16-1)

Outputs the demodulated AF signal, or a 12 kHz IF signal.

① The output level is set, regardless of the volume control.

⑭ REMOTE CONTROL JACK [REMOTE] (pp. 2-3, 16-2)

Connects to a PC for remote control using CI-V commands. (3.5 mm: 1/8 in (d))

⑮ [USB] (B type) PORT (p. 2-3, 16-1)

Connects to a PC.

- Outputs the decoded FSK (RTTY) or D-STAR data.
- Outputs the demodulated AF signal or 12 kHz IF signal.
- Interface for the optional CS-R8600 or RS-R8600.
- Interface for the remote control by the CI-V commands.

⑯ [MUTE] JACK/[MUTE] SWITCH (pp. 2-3, 16-1)

Used for the Mute function, or Bit Error Rate (BER) Measurement function. (3.5 mm: 1/8 in (d))

① Slide the switch to the left when you use the Mute function. The IC-R8600's receive circuitry is deactivated by the input voltage.

① Slide the switch to the right when you use the BER Measurement function.

⑰ LAN PORT [LAN] (pp. 2-3, 16-1)

Connects to a network to use the functions shown below.

- Automatic time synchronization.
- Outputs the received signal in demodulated AF signal, or in 12 kHz IF signal, through the network.
- Remotely controlling using the optional RS-R8600.

Touch panel display

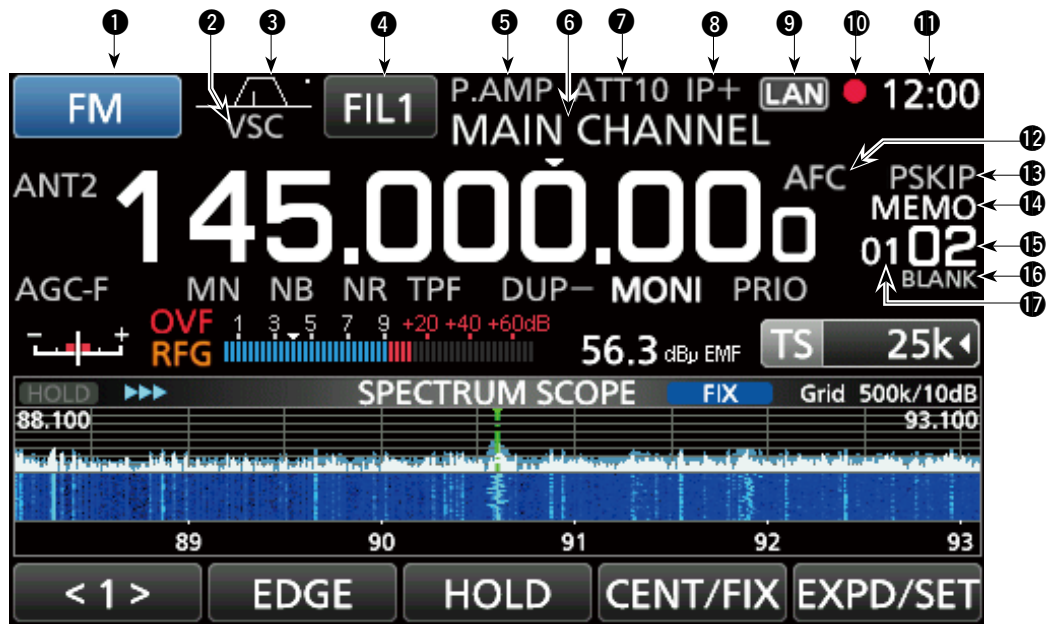

(This screen is only an example.)

- 1 MODE INDICATOR** FM (p. 3-1)
Displays the selected receive mode.
- 2 VSC INDICATOR** (pp. 9-11, 5-10)
Appears while the Voice Squelch Control (VSC) function is ON.
SCRM: Appears while the Scrambler function is ON.
ENCR: Appears while the Encryption function is ON.
- 3 PASSBAND WIDTH INDICATOR (BW/SFT)** (pp. 5-2, 5-9)
 - Graphically displays the digital IF filter passband width and the shift amount.
 - While the Tone/Digital Squelch function is ON, displays the tone/digital squelch type.

TSQL: Tone squelch	COM ID: Common ID
DTCS: Digital tone squelch	CC: -
CSQL: Digital code squelch	RAN: Radio access number
NAC: Network access code	UC: User code
- 4 IF FILTER INDICATOR** FIL1 (p. 5-3)
Displays the selected IF filter (FIL1, FIL2 or FIL3).
- 5 PREAMP INDICATOR** (pp. 1-7, 5-1)
Is displayed while the preamplifier is ON.
- 6 MEMORY NAME READOUT** (p. 8-5)
Displays the memory name if entered.
- 7 ATTENUATOR INDICATOR** (ATT10/ATT20/ATT30) (pp. 1-7, 5-1)
Is displayed while the attenuator is ON.
- 8 IP+ ICON** (pp. 1-7, 5-2)
Is displayed while the IP Plus function is ON.
- 9 NETWORK CONTROL INDICATOR** LAN
Is displayed while the IC-R8600 is remotely controlled by the optional RS-R8600, through the network.
- 10 VOICE RECORDER ICON** ● / || (p. 6-1)
Is displayed while recording to indicate the recording status.
- 11 CLOCK READOUT** (p. 10-1)
Displays the current local time.
ⓐ Touch the readout to display both the current local time and UTC time.
- 12 AFC INDICATOR** (p. 5-5)
Is displayed while the Automatic Frequency Control (AFC) function is ON.
- 13 SKIP INDICATOR** (pp. 9-9, 9-10)
SKIP: Memory Skip
PSKIP: Program Skip
- 14 OPERATING MODE INDICATOR** (p. 3-1)
VFO: VFO mode
MEMO: Memory mode
- 15 MEMORY CHANNEL READOUT** (pp. 3-1, 8-2)
Displays the selected memory channel number.
- 16 BLANK MEMORY CHANNEL INDICATOR** (p. 8-3)
Is displayed when the selected memory channel is blank.
- 17 MEMORY CHANNEL GROUP INDICATOR** (p. 8-1)
00~99: Memory channel group number
A: Auto memory write group
S: Scan skip group
P: Programmable scan edge group

1 PANEL DESCRIPTION

Touch panel (Continued)

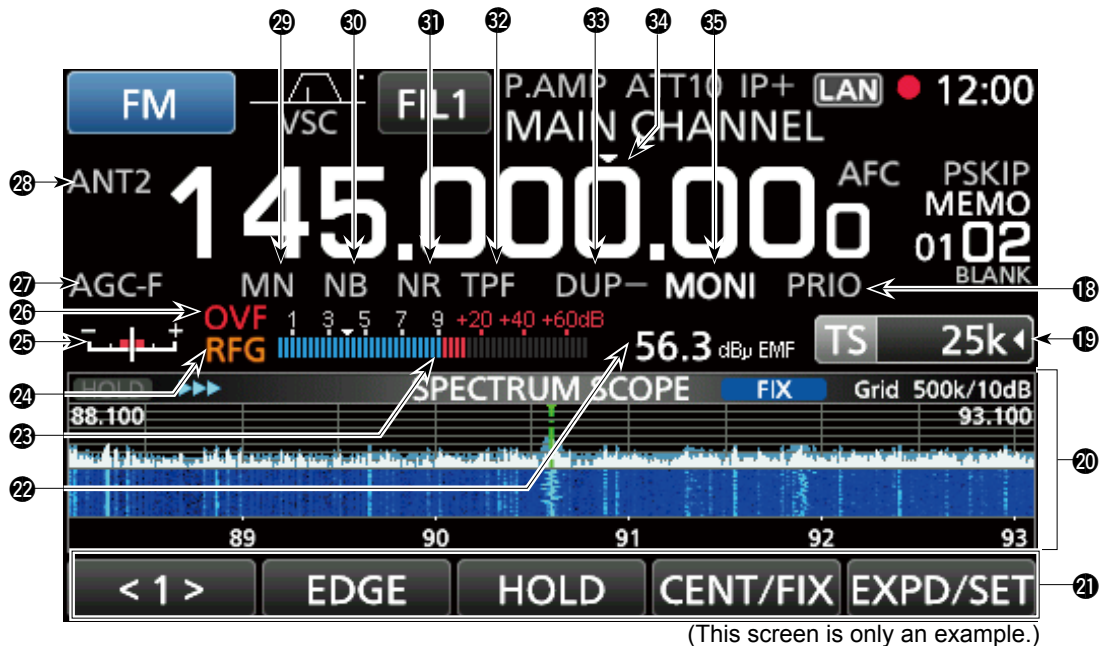

- 18 PRIORITY INDICATOR (p. 9-2)**
Is displayed during a Priority scan.
① Blinks while the squelch is forced to open during a Priority scan. (p. 9-3)
- 19 TUNING STEP INDICATOR TS 25k (p. 3-2)**
Displays the currently selected tuning step.
① If the tuning step is set by the programmable tuning step, "◀" is displayed by the indicator.
- 20 FUNCTION SCREEN**
Displays the operating parameters, modes, frequencies and indicators, depending on your selections.
- 21 FUNCTION GUIDES**
Displays the currently accessible function.
- 22 RECEIVED SIGNAL STRENGTH INDICATOR (p. 3-4)**
Displays the absolute received signal strength in terminated or open load measurement.
- 23 SIGNAL METER (p. 3-4)**
Indicates the signal strength in S-meter/dBμ/dBμ(EMF)/dBm.
- 24 RF GAIN (RFG) (p. 3-1)**
Is displayed when the RF gain is set to less than 100% to indicate that the RF gain is reduced.
- 25 TUNING INDICATOR (p. 3-4)**
Displays the detuned level in the FM, WFM, FSK and DIGITAL modes.
- 26 OVERFLOW (OVF) INDICATOR (pp. 3-1, 5-1)**
Is displayed when an excessively strong signal is received. (Normally, "S" is displayed to in the S-Meter mode)
- 27 AGC INDICATOR (pp. 1-7, 5-1)**
Displays the selected AGC time constant setting. (AGC-F: Fast, AGC-M: Mid, AGC-S: Slow or AGC-OFF: OFF).
- 28 ANTENNA INDICATOR (p. 3-3, 5-1)**
Displays the selected antenna (ANT1, ANT2 or ANT3) only when the frequency is set to 10 kHz ~ 29.999999 MHz.
- 29 NOTCH INDICATOR (AN/MN) (pp. 1-7, 5-2)**
Is displayed while the Notch function is ON. (AN: Auto Notch or MN: Manual Notch)
- 30 NOISE BLANKER INDICATOR (NB) (pp. 1-7, 5-4)**
Is displayed while the Noise Blanker function is ON.
- 31 NOISE REDUCTION INDICATOR (NR) (p. 1-7, 5-4)**
Is displayed while the Noise Reduction function is ON.
- 32 TWIN PEAK FILTER INDICATOR (TPF) (p. 5-7)**
Is displayed while the Twin Peak Filter function is ON.
- 33 DUP INDICATOR (DUP-/DUP+) (pp. 1-7, 5-4)**
Is displayed while in the Duplex mode.
- 34 TS INDICATOR ("▼") (p. 3-2)**
Is displayed when the TS function is on. The frequency changes according to the tuning step set in TUNING STEP INDICATOR (19).
① Touch kHz digit to turn OFF the TS function.
- 35 MONITOR INDICATOR (MONI) (p. 3-1)**
Appears while the Monitor function is ON.

Touch panel (Continued)

◇ MULTI DIAL MENU (DIAL A)

- When rotating (DIAL A).



- When pushing (DIAL A).

① Touch to select an item, then rotate (DIAL A).

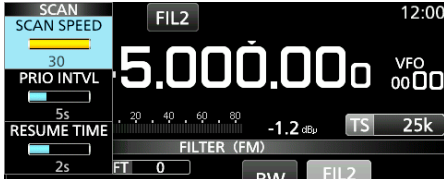

- When holding down (DIAL A) for 1 second.

① Touch an item.



◇ MULTI DIAL MENU (DIAL B)

- When rotating (DIAL B).



- When pushing (DIAL B).

① Touch to select an item, then rotate (DIAL B).

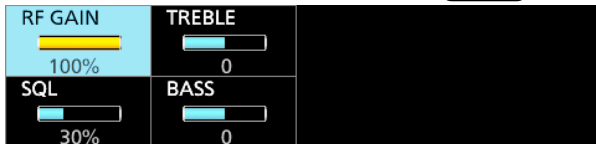

- When holding down (DIAL B) for 1 second.

- The Monitor function is turned ON ([RECEIVE] lights green).
- ① Release (DIAL B) to turn OFF the Monitor function.

◇ MULTI DIAL MENU (DIAL C)

- Push (DIAL C) to open the Multi Dial menu. Push again to close the menu.
- While the Multi Dial menu is opened, touch the desired item and rotate (DIAL C) to set the desired value or function.

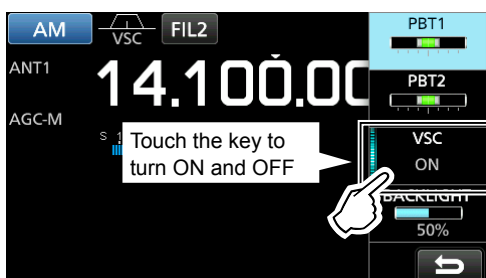

Multi dial menu items

Displayed items differ, according to the selected receive mode.

FM/WFM	AM/S-AM	SSB	CW
AFC* ¹	PBT1	PBT1	PBT1
	PBT2	PBT2	PBT2
VSC* ¹	VSC* ¹	VSC* ¹	CW PITCH
BACKLIGHT	BACKLIGHT	BACKLIGHT	BACKLIGHT
FSK	DIGITAL	NB* ²	NR* ²
PBT1	AFC* ¹	LEVEL	LEVEL
PBT2		DEPTH	
TPF* ¹		WIDTH	
BACKLIGHT	BACKLIGHT		
NOTCH* ²			
POSITION			
WIDTH* ¹			

*¹Touch to turn the function ON or OFF.

*² Displayed when you touch the item on the FUNCTION screen for 1 second.

◇ MENU screen

- Push (MENU) to open the MENU screen.



① The menu items differ, depending on the selected receive mode.

◇ QUICK MENU

- Push (QUICK) to open the QUICK MENU.
- ① The items differ, depending on the operating condition.

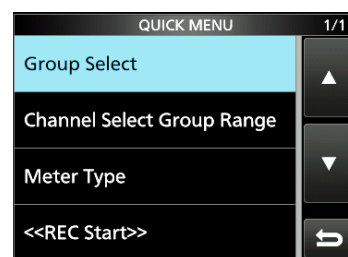

QUICK MENU example

1 PANEL DESCRIPTION

Touch panel (Continued)

◇ FUNCTION screen

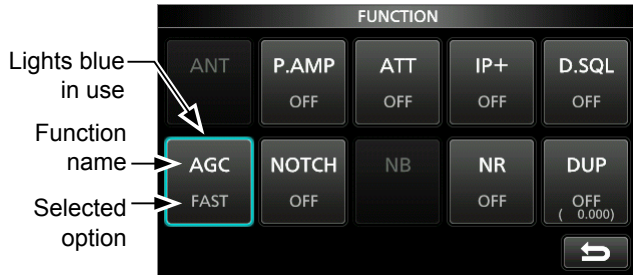

- Push **FUNCTION** to open the FUNCTION screen.
 ① To close the FUNCTION screen, push **EXIT**.

◇ FUNCTION items

- Touch an item to change its setting.

FUNCTION	OPTION
ANT	ANT1, ANT2 or ANT3
P.AMP	OFF or ON
ATT	OFF, 10dB, 20dB or 30dB
IP+	OFF or ON
TONE*1	OFF, TSQL or DTCS
TONE/SHIFT*2	FSK RX Frequency, FSK Tone Frequency or FSK Shift width
D.SQL*1	D-STAR: OFF or CSQL P25: OFF or NAC dPMR: OFF, COM ID or CC NXDN: OFF or RAN DCR: OFF or UC
AGC*1	FAST, MID or SLOW
NOTCH*1	OFF, AN or MN
NB*1	OFF or ON
SCRAM*1	OFF or ON
ENCRYP*1	OFF or ON
NR*1	OFF or ON
DUP*1	OFF, DUP- or DUP+

*1 Touch for 1 second to open its function menu.

*2 Touch to open its function menu.

Keyboard entering and editing

◇ Entering and editing characters

You can enter and edit characters in the items in the following table.

Category	Edit items	Total character number
	Selectable characters	
MEMORY	GROUP NAME MEMORY NAME	16
	A to Z, a to z, 0 to 9, (space), @ % & # + - = [] / () : ; ^ ! ? < > - . ,	
DISPLAY	OPENING COMMENT	10
	A to Z, 0~9, (space), / @ - .	
SD card	FILE NAME*	15
	A to Z, a to z, 0 to 9, (space), @ % & # + - = [] / () : ; ^ ! ? < > . " \$ ' * \ _ ` { } ~	
TIME	NTP SERVER ADDRESS	64
	A to Z, a to z, 0~9, (space), - .	
NETWORK	NETWORK NAME	15
	A to Z, 0 to 9, (space), ! " # \$ % & () + , - . : ; = @ [] ^ _ ` { } ~	
	NETWORK RADIO NAME	16
	A to Z, a to z, 0 to 9, (space), ! " # \$ % & ' () * + , - . / : ; < > = ? @ [] ^ _ ` { } ~	
	NETWORK USER1 ID NETWORK USER2 ID	16
	A to Z, a to z, 0 to 9, (space), ! " # \$ % & ' () * + , - . / : ; < > = ? @ [] ^ _ ` { } ~	
NETWORK USER1 PASSWORD NETWORK USER2 PASSWORD	16	
	A to Z, a to z, 0 to 9, (space), ! " # \$ % & ' () * + , - . / : ; < > = ? @ [] ^ _ ` { } ~	

*Illegal characters " / : ; * < > "

Keyboard entering and editing (Continued)

◇ Keyboard types

You can select the Full Keyboard or Tenkey in “Keyboard Type” in the QUICK MENU.

1. When the keypad is opened, push **QUICK**.
2. Touch to select the keyboard type.

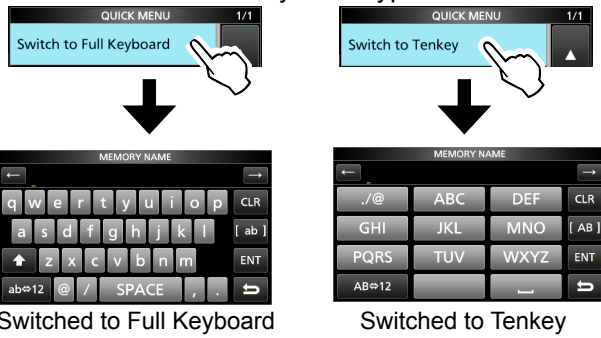

① Information

You can also select the Keyboard type in the Set mode.

MENU » **SET > Function > Keyboard Type**

◇ Entry example

Example: Entering memory name "MAIN CHANNEL."

1. Open the MEMORY screen.
2. Rotate **DIAL C** to select the channel you want to enter a name in.

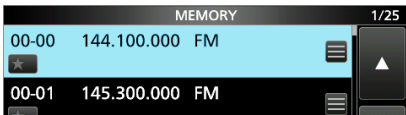

3. Push **QUICK**.
4. Touch “Edit Name.”

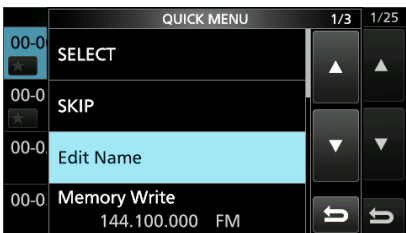

5. Touch **↑** for 1 second to select the upper case entry mode.
6. Enter a name of up to 16 characters, then touch **[ENT]**.
 - The entered name is displayed.

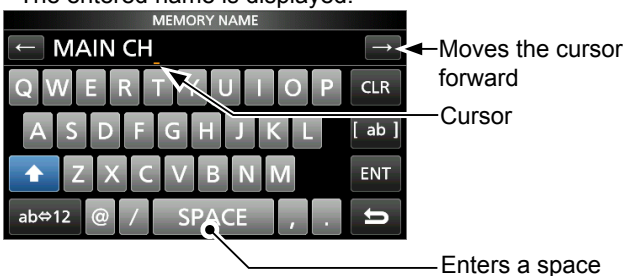

Selecting a location

Select a location for the receiver that allows adequate air circulation, free from extreme heat, cold or vibrations, and other electromagnetic sources. An improper location may damage the receiver.

Never place the receiver in areas such as:

- Temperatures below -10°C ($+40^{\circ}\text{F}$) or above $+60^{\circ}\text{C}$ ($+140^{\circ}\text{F}$).
- Unstable place slope or vibrate.
- In direct sunlight.
- High humidity and temperature.
- Dusty environments.
- Noisy environments.

Heat dissipation

- **DO NOT** place the receiver against walls, or put anything on top of the receiver. This may block airflow.
- **NEVER** install the receiver in a place without adequate ventilation. Heat dissipation may be reduced, and the receiver may be damaged.

For desktop use

The receiver has a stand for desktop use.

- Pull the stand until it locks in place.

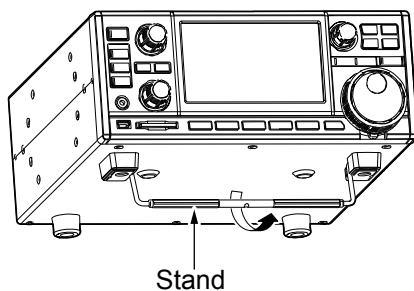

CAUTION: NEVER carry the receiver by holding the stand, dials, controls and so on. This may damage them.

Grounding

To prevent electrical shock, interfere from other electric devices and other problems, ground the receiver using the ground terminal [GND] on the rear panel.

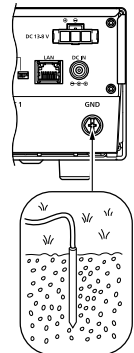

For best results, connect a heavy gauge wire or strap to a long ground rod. Make the distance between the [GND] terminal and ground as short as possible.

⚠ WARNING! NEVER connect the [GND] terminal to a gas or electric pipe, since the connection could cause an explosion or electric shock.

Connecting a DC power supply

◇ Power supply

You can use any of the power sources listed below.

- 13.8 V DC power supply (User supplied)
- Optional SP-39AD (External speaker with built-in power supply)
- Optional AD-55NS (Power adapter)

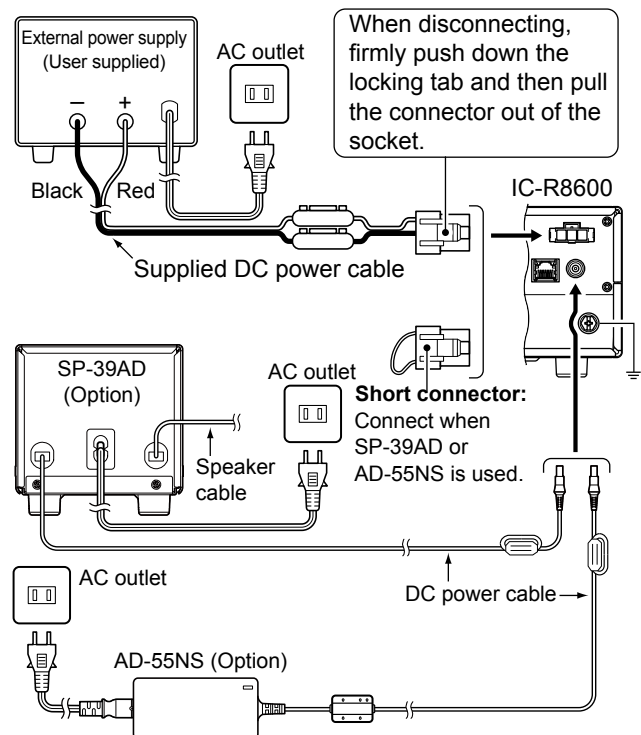

◇ Turning the receiver's power ON or OFF

- Push **POWER** to turn ON the power.
- Hold down **POWER** until the "POWER OFF..." is displayed.

Connecting an antenna

Antenna is a very important element in receiving signal. Use the antenna and coaxial cable of appropriate impedance.

When you use a long wire antenna for short wave bands, use one as long as possible (at least 10 m, 32.8 ft).

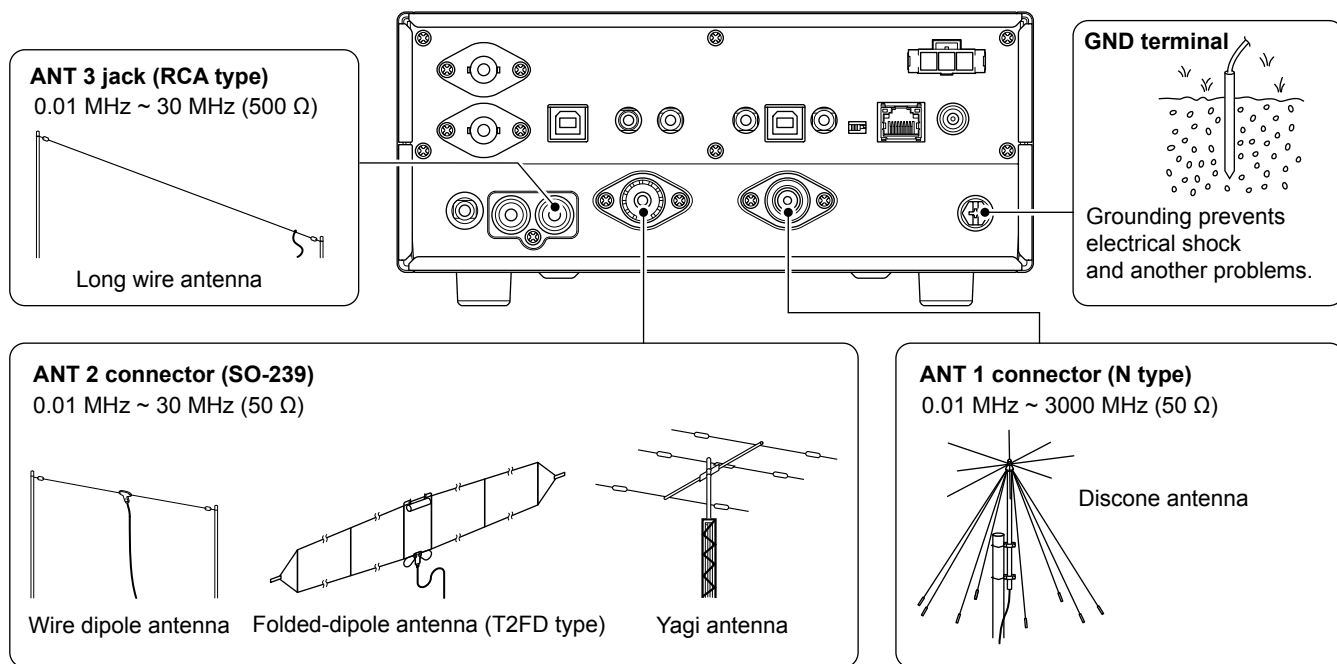

FSK (RTTY) connections

The receiver has a built-in FSK (RTTY) decoder.

Connect the IC-R8600 and a PC that has an FSK (RTTY) software (user supplied) installed through the USB port, to decode the FSK signal. Refer to the software application's instruction manual for setup details.

① Icom does not guarantee performance of the application software, PC, network device or network settings.

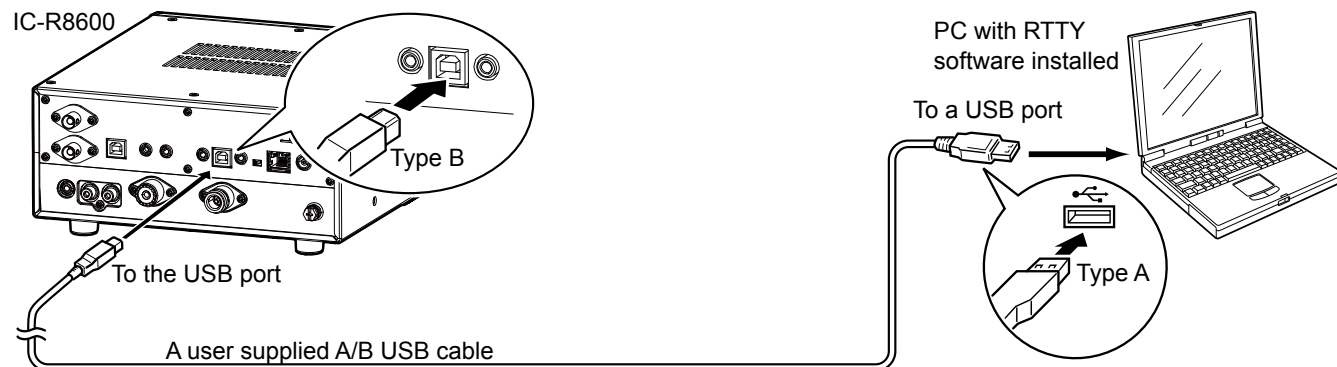

① Information.

• You can change the FSK output port on the MENU screen.

MENU » **SET > Connectors > USB (Front)**

MENU » **SET > Connectors > USB (Rear)**

• You can download the USB driver and installation guide from the Icom website.

<http://www.icom.co.jp/world/support/download/firm/index.html>

External device connection

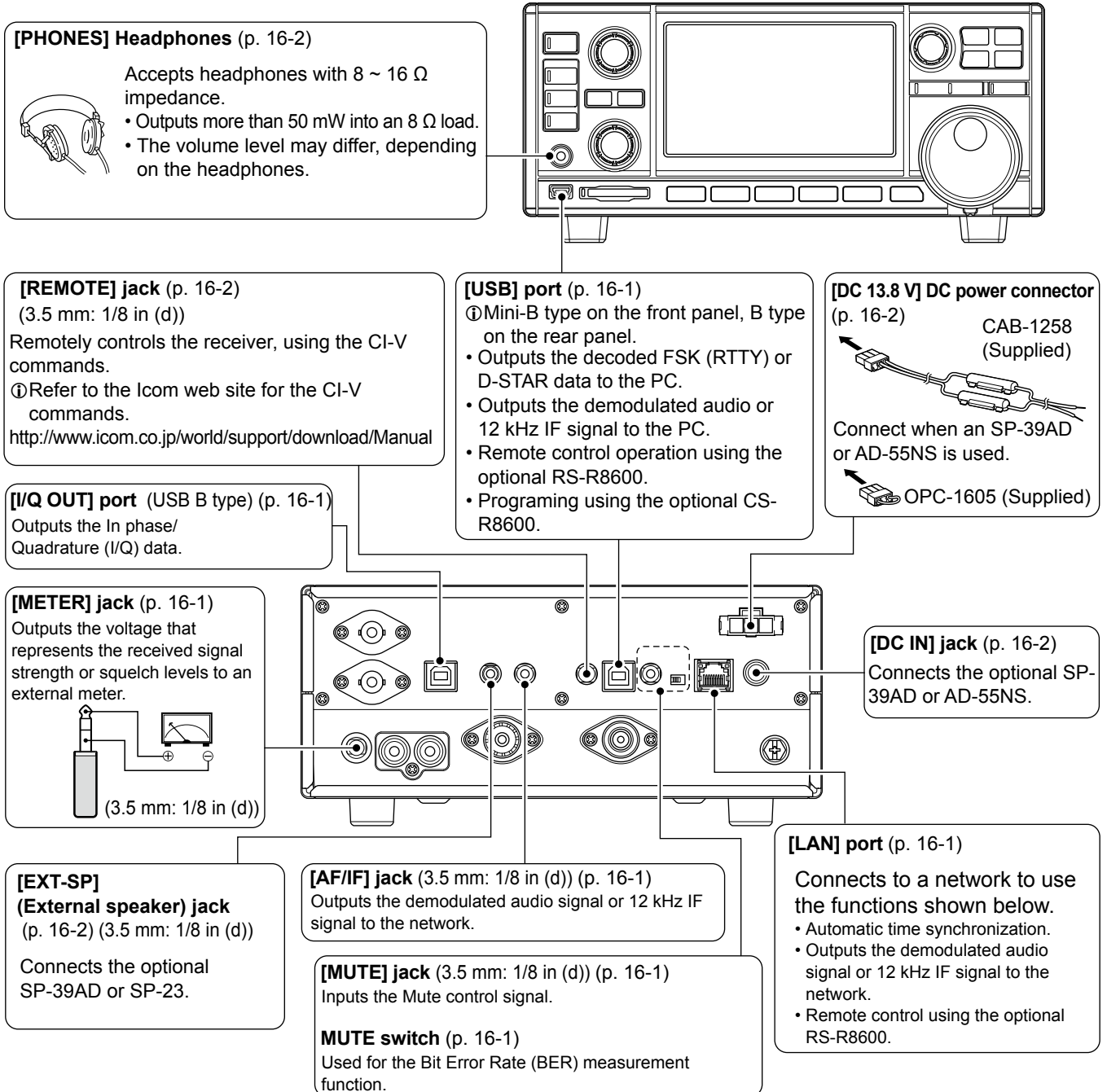

① Icom does not guarantee the performance of the PC, network device or network settings.

Adjusting the volume level

Rotate **[DIAL B]** to adjust the volume level.
 • While adjusting, the volume level is indicated in %.

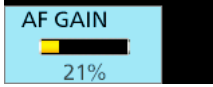

① The status or position of each key or dial is stored and recalled when the power is turned ON.

RF gain/SQL level/Audio tone

1. Push **[DIAL B]**.
2. Touch an item to select. (Example: RF GAIN)

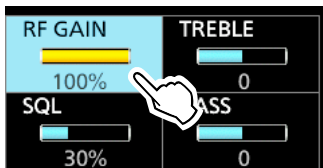

3. Rotate **[DIAL B]**.
 - Settable range RF GAIN (Sensitivity): 0 ~ 100%
 - SQL (Squelch): 0 ~ 100%
 - TREBLE (Higher tone): -15 to +15
 - BASS (Lower tone): -15 to +15

◆ Noise squelch

The Noise Squelch allows the audio to be heard only while receiving a signal that includes less noise than a set level.

- Activates when the squelch level is set to between 30% and 50% in the FM, AM, S-AM or DIGITAL mode.
- A higher level blocks weak signals. A lower level allows you to hear weak signals including noise.

① While the squelch is closed, the noise audio is muted and the [RECEIVE] indicator is OFF.

◆ S-meter squelch

The S-meter Squelch mutes the speaker sounds when the signal strength is less than the set value.

- Activates when the squelch level is set to between 50% and 100% in any mode.
- The squelch level is indicated by the position of "▼".



S-meter squelch level

① When the received signal is stronger than the S-meter squelch level designated by the "▼," the squelch opens.

① Information

When the squelch circuitry activates to emit the audio, "Squelch opens." When the squelch circuitry mutes the audio emission, "Squelch closes."

◆ RF gain

Normally, set the RF gain to maximum (100%).

- You can adjust the RF gain to decrease the interference or noise from a nearby strong station.
- **RFG** indicates that the RF gain is reduced.
 - ① If a strong signal is received and **OVF** (Overflow) appears, reduce the RF gain until **OVF** disappears.

Monitor function

- Hold down **[DIAL B]** to forcibly open the squelch.
 - [MONI] appears and [RECEIVE] lights.
 - ① You can change the function in the digital mode setting on the MENU screen.

[MENU] » **[SET > Digital Set > Digital Monitor]**

About the VFO and Memory modes

- Push **[V/M]** to select the VFO or Memory mode.

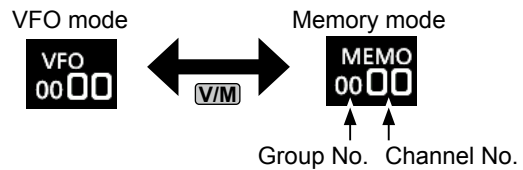

VFO mode

You can set the receive frequency by rotating **[MAIN DIAL]** or by directly entering it with the keypad.

Memory mode

You can set the receive frequency by selecting a preset channel. See Section 8 for details.

Selecting the receiving mode

1. Touch the receiving mode icon. (Example: FM)



2. Touch to select the receive mode. (Example: AM)



MODE screen

① When the mode key is touched for 1 second, the selectable modes differ. See the table below.

• Selectable modes when the mode key is touched

Mode key	Receiving mode
[FM]	FM
[WFM]	WFM
[AM]	AM ↔ S-AM(D)*
[SSB/CW]	USB* ↔ CW*
[FSK]	FSK*
[DIGITAL]	D-STAR→P25→dPMR→NXDN-VN →NXDN-N→DCR→D-STAR

*Touch for 1 second to select other modes. See the table below.

• Selectable modes when the mode is touched for 1 second

Mode key	Receiving mode
[AM]	S-AM(D)→S-AM(U)→S-AM(L)→S-AM(D)
[SSB/CW]	CW ↔ CW-R, or USB ↔ LSB
[FSK]	FSK ↔ FSK-R

① You can choose the receiving mode icons that appears when you touch the [DIGITAL] key.

[MENU] » **[SET > Digital Set > Digital Mode Select]**

Selecting the receiving mode (continued)

① Information

• S (Synchronous)-AM mode:

The Synchronous AM demodulation is a receive method that mixes the incoming signal with a pure carrier frequency with no level variation, then extracts one of the two sides (USB or LSB) signal which is free from interferences.

This method is effective to reduce the distortions due to fading, or interferences from adjacent stations.

• When the "D-STAR" and "FM" icons alternately blink:

Indicates that an FM signal is being received while in the Digital (D-STAR) mode.

Setting the frequency

- Rotate **(MAIN DIAL)** to set the receive frequency.
 - The displayed frequency changes depending on the selected tuning step.

◇ Directly entering a frequency

You can set the frequency with the keypad.

Example: Entering 383.000000 MHz

1. Touch the MHz digits.

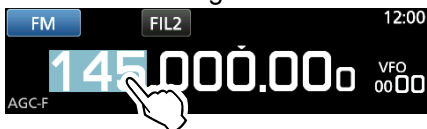

2. Start entry with the MHz digits.

- ① To clear the entry, touch [CE].
- ① To clear the entry and return to the previous screen, push [EXIT].



3. Touch [ENT] to set the entered frequency.

- Closes the F-INP screen.
- ① If you touch [ENT] when the digits under 100 kHz are not entered, "0" will be automatically entered into the blank digits.

Entry examples

- 14.025000 MHz: [1], [4], [•], [0], [2], [5], [ENT]
- 21.240000 MHz: [2], [1], [•], [2], [4], [ENT]
- 14 MHz: [1], [4], [ENT]
- 150 kHz: [0], [•], [1], [5], [ENT]
- Changing from 21.240000 MHz to 21.360000 MHz: [•], [3], [6], [ENT]
(You can omit MHz digit entry.)

Changing the Tuning Step

1. Touch the TS indicator.

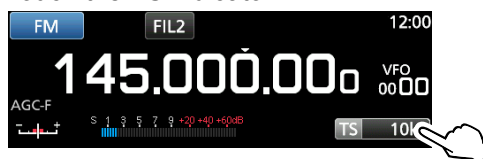

2. Touch to select the tuning step. (Example: 20k)

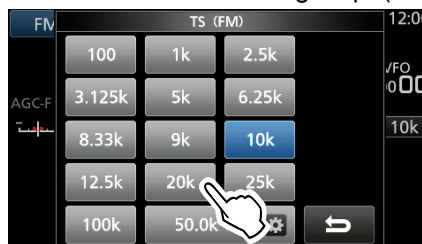

- The tuning step is set and returns to the previous screen.

◇ About the Tuning Step (TS) function

By turning the Tuning Step function ON or OFF, you can change the frequency in MHz steps or 10 Hz.

Changing the frequency in MHz steps:

- Touch the MHz digit for 1 second, then rotate **(MAIN DIAL)**.



The Tuning Step function is ON.

Changing the frequency in 10 Hz steps:

- Touch the kHz digit to turn OFF the TS function, then rotate **(MAIN DIAL)**.



The Tuning Step function is OFF.

- ① To set the frequency in 1 Hz steps, directly enter the frequency with the keypad.

Changing the Tuning Step (Continued)

◇ About the Programmable Tuning Step function

You can preset the tuning step between 0.1 kHz and 999.9 kHz in 100 Hz steps.

1. Touch the TS indicator.

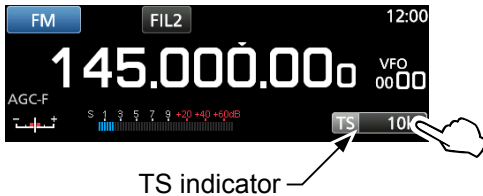

2. Touch (Programmable TS icon).

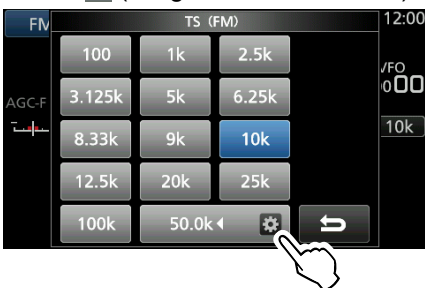

3. Start entry with the kHz digits. (Example: 20.5 kHz)
 - ① To clear the entry, touch [CE].
 - ① Push [EXIT] to cancel the entry.
 - ① You can also enter by rotating (DIAL C).



4. Touch [ENT] to set the entered frequency.
 - Closes the Programmable TS screen.

Entry examples

- 14.2 kHz: [1], [4], [•], [2], [ENT]
- 14.0 kHz: [1], [4], [ENT]
- 150 kHz: [1], [5], [0], [ENT]
- Change 14.2 kHz to 14.5 kHz: [•], [5], [ENT] (You can omit kHz digit entry.)

◇ About the Auto Tuning Step function

When you rapidly rotate (MAIN DIAL), the tuning speed automatically accelerates.

- ① You can change this setting on the MENU screen.

MENU » SET > Function > MAIN DIAL Auto TS

Selecting the antenna

The IC-R8600 has three antenna connectors: ANT1, ANT2, and ANT3. You can use either ANT1, ANT2, or ANT3 for receiving below 30 MHz.

1. Rotate (MAIN DIAL) to set a frequency to below 30 MHz (10 kHz–29.99999 MHz).
 - The selected antenna connector indicator appears under the receiving mode icon.
2. Touch the antenna connector indicator.
 - Each touch changes the selected antenna connector (ANT1, ANT2 and ANT3).



- ① Next time you set the same frequency, the same antenna connector is automatically selected.

Dial/Panel Lock function

◇ Dial Lock function

The Dial Lock function electronically locks the dial to prevent frequency changes caused by accidentally moving (MAIN DIAL).

- Hold down for 1 second to turn the Dial Lock function ON or OFF.
 - The [LOCK] LED lights while the function is ON.
 - This function does not work when the MENU, FUNCTION, QUICK menu, Set mode or Scan Start screen is displayed.
- ① You can change this setting on the MENU screen.

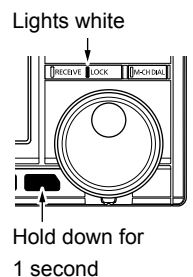

MENU » SET > Function > [SPEECH/LOCK] Switch

◇ Panel Lock function

The Panel Lock function locks all the controls on the front panel except (POWER) and (P.LOCK).

- Push to turn the Panel Lock function ON or OFF.
 - ① P.LOCK indicator lights while the panel is locked.
 - Holding down for 1 second turns the Dial Lock function ON, and turns OFF the display.
 - The indicator lights while the function is ON.
 - This function does not work when the MENU, FUNCTION, QUICK menu, Set mode or Scan Start screen is displayed.
 - ① You can set to lock only keys on the MENU screen.

MENU » SET > Function > P.LOCK Key

Adjusting Backlight dimmer

1. Push **[DIAL C]**.
 - Opens the setting menu.
2. Touch **[BACKLIGHT]**.
 - Settable range: 0 (dark) ~ 100% (bright)

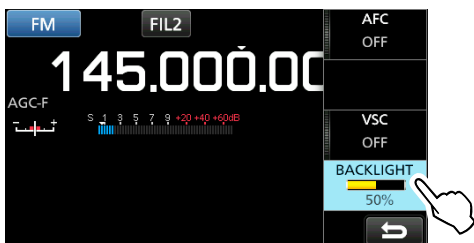

3. Rotate **[DIAL C]** to adjust the brightness.
 - ① You can reset to the default setting on the MENU screen.

[MENU] » SET > Display > LCD Backlight

Fine tuning

◇ When receiving FM, WFM or DIGITAL signal

You can have a fine tuning into the signal by setting the marker on the tuning indicator to the center position.

- ① In the WFM mode and when the AFC function is ON, the marker may not be steady in the center position.



◇ When receiving FSK signal

You can have a fine tuning into the signal by tuning to where both “◀” and “▶” are displayed in the tuning indicator.



Selecting meter display

You can display one of the 4 different receive signal parameters.

- Touch the meter to select the parameter you want to display.

① You can select the meter display also on the QUICK menu.

◇ Meter display types

<p>• S-meter: Received signal strength</p> <p>Relative signal strength represented by S1 to S9. At S9, the input signal level is 50µV (34 dBµ). At S9 +20 dB, the input signal level is 54 dBµ.</p>
<p>• dBµ meter: Absolute voltage (Terminated)</p> <p>0 dBµ is the level corresponding to 1 µV that is produced on a 50 Ω terminated load.</p>
<p>• dBµ EMF meter: Absolute voltage (Opened)</p> <p>EMF (Electro Motive Force) is the unit of voltage produced at an opened terminal. ① Indicated in 6 dB higher than a 50 Ω terminated load.</p>
<p>• dBm meter: Absolute power</p> <p>0 dBm is the level corresponding to 1 mW that is produced at a 50 Ω terminated load.</p>

Spectrum scope screen

This spectrum scope enables you to display the activity on the selected frequency range, as well as the relative strengths of various signals.

The IC-R8600 has two spectrum scope modes. One is the Center mode, and another one is the Fixed mode. You can also turn the Waterfall display ON or OFF. In addition, you can select a Mini scope screen to save screen space.

Center mode screen

The operating frequency is always displayed in the center of the screen.

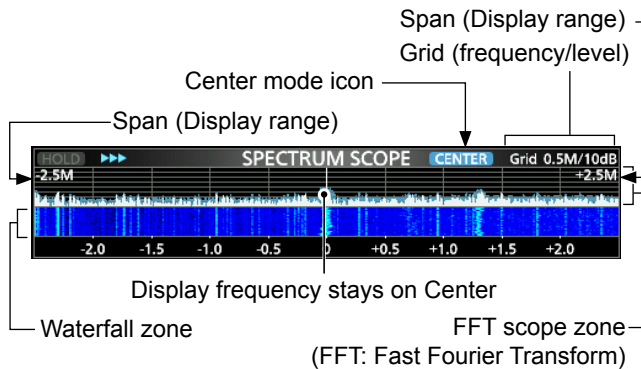

Fixed mode screen

The activity on the selected frequency range can easily be observed using this mode.

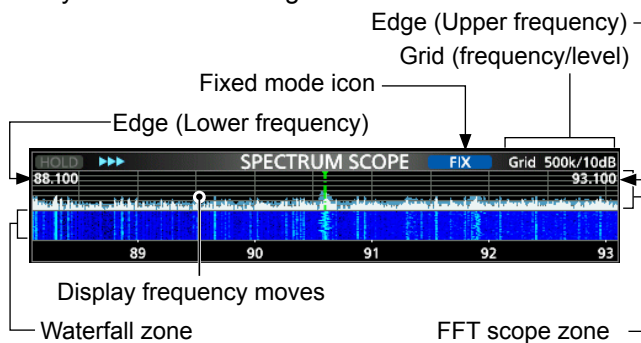

RX Marker

In the Fixed mode, the RX Marker always marks the receive frequency on the SPECTRUM SCOPE screen.

- ① The marker marks the receive frequency even during peak hold.
- ① The RX Marker is not displayed in the Center mode.
- ① When changing the frequency, the Waterfall maker is displayed on the Waterfall zone.

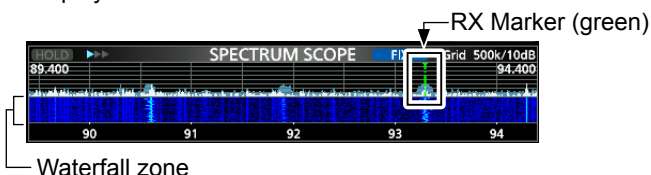

Using the Spectrum Scope

1. Open the SPECTRUM SCOPE screen.

[MENU] » [SCOPE]

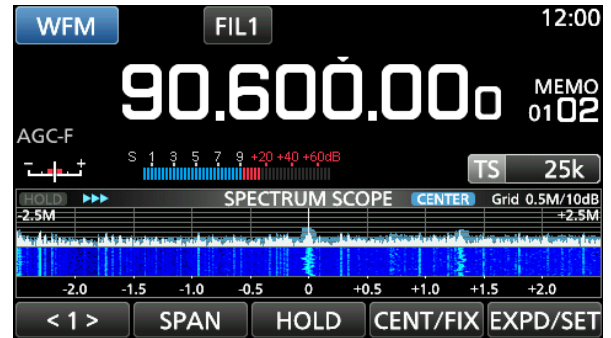

SPECTRUM SCOPE screen

- Touch <1> to switch to Menu 2.

< 2 > [REF] [SPEED] [MARKER] [EXPD/SET]

Function menu (Menu 2)

2. To exit the SPECTRUM SCOPE screen, push [EXIT].

[Function menu keys]

Key	Action	
< 1 > < 2 >	Toggles the Function menu between Menu 1 and Menu 2.	
SPAN	In the Center mode, selects the scope span. • Selectable spans: ± 2.5 , 5.0, 10, 25, 50, 100, 250, 500 kHz, 1.0 MHz and 2.5 MHz	
EDGE	In the Fixed mode, selects the Edge frequencies.	
HOLD	Touch	Turns the Peak Hold function ON or OFF. • “[HOLD]” and the Marker are displayed. Freezes the current spectrum.
	Touch for 1 second	Clears the Peak Hold level display.
CENT/FIX	Selects the Center or Fixed mode.	
EXPD/SET	Touch	Selects the Expanded or Normal screen.
	Touch for 1 second	Opens the SCOPE SET screen.
REF	Opens the Reference level window. ① Rotate [MAIN DIAL] to adjust the Reference level. ① Touch again to close the window.	
SPEED	Selects the sweep speed. • “>>>”, “>>”, or “>” indicates FAST, MID, or SLOW.	
PEAK	Displays the function keys for the Peak Search function. (p. 4-3)	

4 SCOPE OPERATION

Spectrum scope screen (Continue)

◇ Setting the span

Set the frequency range around the receive frequency.

Settable span:

±2.5, 5.0, 10, 25, 50, 100, 250, 500 kHz, 1.0 and 2.5 MHz.

1. Open the SPECTRUM SCOPE screen.
MENU » **SCOPE**
2. Touch [CENT/FIX] to select the Center mode.
 • Each touch changes between the Center and Fixed mode.
3. Touch [SPAN].

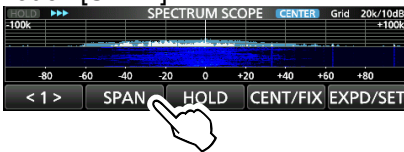

4. Touch [-] or [+].
 • The span range changes.

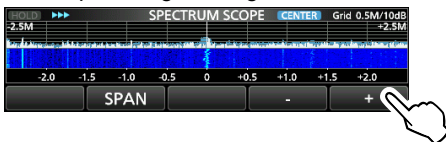

5. To exit the SPECTRUM SCOPE screen, push **EXIT** several times.

◇ Setting the range

The signals within a specified frequency range are displayed.

Settable range: 0.010 ~ 3000.000 MHz.

1. Open the SPECTRUM SCOPE screen.
MENU » **SCOPE**
2. Touch [CENT/FIX].
 • Each touch changes between the Center and Fixed mode.
3. Touch [EDGE].

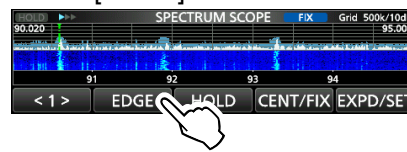

4. Touch [EDIT].

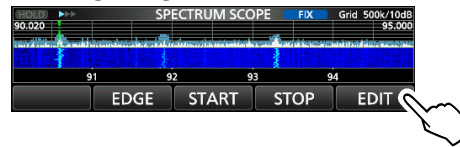

5. Touch [◀▶] to select the upper or lower edge.
 • The selected frequency edge is highlighted.



6. Touch the numeric keys, or rotate **(DIAL C)** to change the frequency, then touch [ENT].
 ① When the operating frequency moves outside the upper or lower Edge frequency, "<<" or ">>" is displayed in the upper side corners of the SPECTRUM SCOPE screen.

">>" blinks when the frequency is outside the higher edge (Example: 94.600).

"<<" blinks when the frequency is outside the lower edge (Example: 92.600).

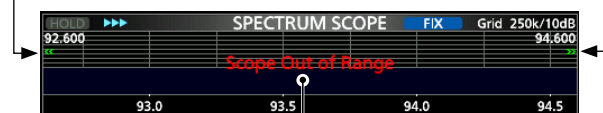

When the frequency goes further away, "Scope Out of Range" is displayed.

7. To exit the SPECTRUM SCOPE screen, push **EXIT** several times.

Spectrum scope screen (Continue)

◇ Searching for the peak signal

You can find the strongest signal within the scope frequency range.

1. Open the SPECTRUM SCOPE screen.



2. Touch [<1>] to select the [<2>] menu.
① Each touch toggles between menu [<1>] and [<2>].
3. Touch [PEAK].

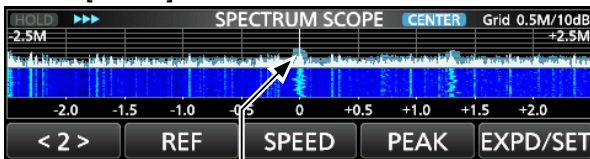

The strongest signal

- The Peak Pointer appears on the strongest signal frequency within the scope frequency range.

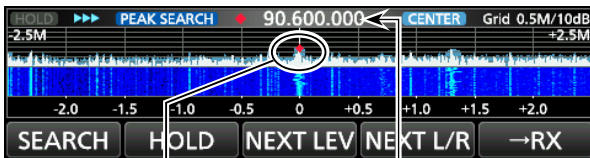

The strongest signal Signal frequency
Peak search mode

4. To exit the peak search menu, push [EXIT].

[Search menu keys]

Key	Action	
SEARCH	Touch to put the peak pointer on the strongest signal frequency.	
HOLD	Touch	Turns the Hold function ON or OFF. • “[HOLD]” and the Marker are displayed. Freezes the current spectrum.
	Touch for 1 second	Clears the Peak Hold level.
NEXT LEV	Enters to the Next Peak level mode. • Popup “NEXT ◀” is displayed. • Rotate (DIAL C) to search for the next peak in level.	
NEXT L/R	Enters to the Peak Select mode. • Popup “NEXT ▶” is displayed. • Rotate (DIAL C) to select the next peak.	
→RX	Touch for 1 second to tune the frequency to the current peak level signal.	

◇ Touch screen operation

When you touch the FFT scope zone or the waterfall zone on the SPECTRUM SCOPE screen, the area will be zoomed in. Then, touch the signal in the zoomed area to tune into the signal on the SPECTRUM SCOPE screen.

1. Open the SPECTRUM SCOPE screen.



2. Touch the Scope screen.
• The area around the touched point is zoomed in.
① Touch out of the zoomed area to close the zoomed window.

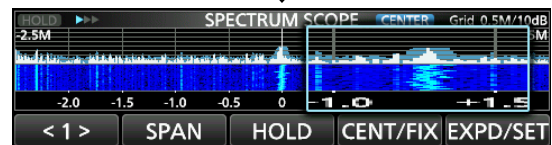
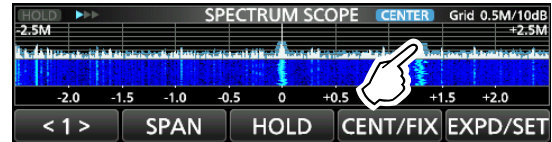

3. Touch the signal in the zoomed area.
• The receiving frequency is tuned into the touched signal frequency.

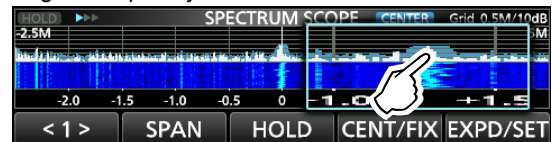

4. To exit the SPECTRUM SCOPE screen, push [EXIT].

◇ Mini scope screen

The Mini scope screen can be simultaneously displayed with another function display, such as the FSK DECODE screen.

- Push [M.SCOPE] to turn the Mini scope screen ON or OFF.

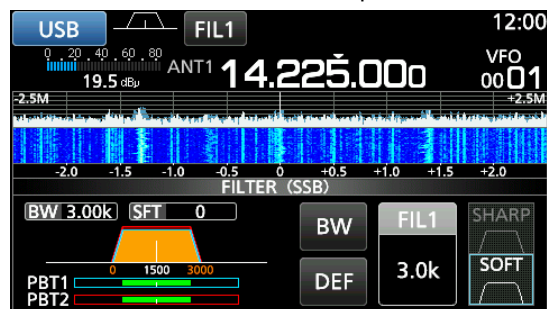

Mini scope screen (with the Filter setting screen)

- ① Hold down [M.SCOPE] for 1 second to display the SPECTRUM SCOPE screen.

Spectrum scope screen (Continue)

◇ Adjusting the Reference level

Adjusting the Reference level of the screen helps you to see a weak signal that is buried in the noise floor.

- Even if this setting is changed, it does not affect the scope input level.
- When you adjust the Reference level, the signal strength for the waterfall also appears to change.

Settable range: -20.0 dB ~ +20.0 dB

1. Open the SPECTRUM SCOPE screen.



2. Touch [<1>].
 - The function menu changes to Menu 2.
3. Touch [REF].

① Each touch opens and closes the window.

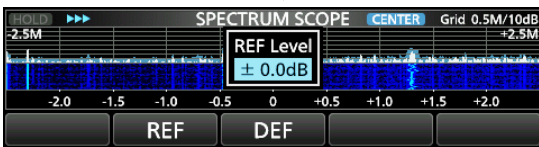
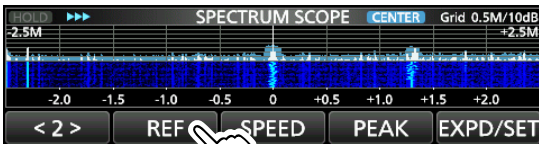

4. Rotate (MAIN DIAL) to adjust the level.
 - ① Touch [DEF] for 1 second to reset to ±0.0 dB.
 - ① Touch [REF] to return to Menu 2.
5. To exit the SPECTRUM SCOPE screen, push [EXIT] several times.

◇ Sweep speed

Select the sweep speed to change the FFT scope refresh interval and the waterfall speed.

① To change only the waterfall speed, select “Slow,” “Mid,” or “Fast” on the Scope set screen. (p. 4-6)

1. Open the SPECTRUM SCOPE screen.

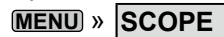

2. Touch [<1>].
 - The function menu changes to Menu 2.
3. Touch [SPEED] several times to select FAST, MID and SLOW.

① Each touch changes the speed.

“▶▶” (MID), “▶” (SLOW) or “▶▶▶” (FAST)

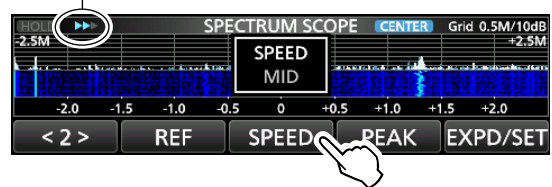

4. To exit the SPECTRUM SCOPE screen, push [EXIT].

Difference in spectrum display

Reference level (+20.0 dB)	Reference level (-20.0 dB)

① If you adjust this setting to a positive level, all signal levels appear stronger.
Or, if you adjust to a negative level, all signal levels appear weaker.

Spectrum scope screen (Continue)

◇ **Scope set screen**

The Scope Set screen is used to configure the scope screen parameters, such as the waveform color.

1. Open the SPECTRUM SCOPE screen.

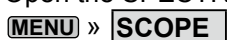

2. Touch [EXP/D/SET] for 1 second.

- Opens the SCOPE SET window.

3. Select the desired item.

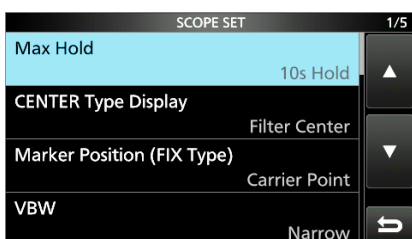

4. Select the option or set the level.

① See to the right for details of the setting items and their options.

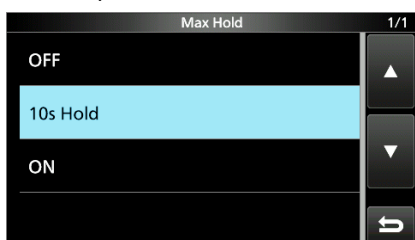

5. To exit the SPECTRUM SCOPE screen, push

[EXIT] several times.

TIP: How to reset to the default setting

Touching the item or its option for 1 second displays the Quick menu, and then touch “Default” to reset to the default setting.

Max Hold (Default: 10s Hold)

Select the peak level holding function.

- OFF: Turns OFF the peak level holding function.
- 10s Hold: Holds the peak spectrum for 10 seconds.
- ON: Turns ON the peak spectrum.

CENTER Type Display (Default: Filter Center)

Select the center frequency of the SPECTRUM SCOPE screen. (Only in the Center mode)

- Filter Center: Displays the selected filter’s center frequency in the center of the SPECTRUM SCOPE screen.
- Carrier Point Center: Displays the carrier point frequency of the selected operating mode in the center of the SPECTRUM SCOPE screen.
- Carrier Point Center (Abs. Freq.*): In addition to the carrier point center setting above, the actual frequency is displayed at the bottom of the scope.

*Abs. Freq. : Absolute Frequency

Marker Position (Fix Type) (Default: Carrier Point)

Select the marker position on the SPECTRUM SCOPE screen. (Only in the Fixed mode)

- Filter Center: Displays the Marker on the selected filter’s center frequency.
- Carrier Point: Displays the Marker on the carrier point frequency of the selected operating mode.

VBW (Default: Narrow)

Select the Video Band Width (VBW).

- Narrow: Sets the VBW to narrow.
- Wide: Sets the VBW to wide.

① When “Wide” is selected, the line drawn on the receive spectrum becomes wide. However, the small edge cannot be drawn.

Averaging (Default: OFF)

Set the FFT scope waveform averaging function to between 2 and 4, or OFF.

- OFF: The FFT scope screen refreshes at each sweep time. This setting displays the critical spectrum view.
- 2, 3, 4: The FFT scope screen averages 2 to 4 sweeps to smoothly display the spectrum.

4 SCOPE OPERATION

Spectrum scope screen (Continue)

◇ Scope set screen (Continued)

Waveform Type (Default: Fill)

Select the outline waveform display for the FFT scope screen.

- Fill: The waveform is drawn only in color.
- Fill + Line: The waveform is drawn in color with an outline.

Waveform Color (Current) (Default: (R) 172 (G) 191 (B) 191)

Set the waveform color for the currently received signals.

① Touch and select the color scale, and then rotate **(DIAL C)**.

Waveform Color (Line) (Default: (R) 56 (G) 24 (B) 0)

Set the waveform outline color for the currently received signals.

① Touch and select the color scale, and then rotate **(DIAL C)**.

Waveform Color (Max Hold) (Default: (R) 45 (G) 86 (B) 115)

Set the waveform color for the received signals maximum level.

① Touch and select the color scale, and then rotate **(DIAL C)**.

Marker Color (RX) (Default: (R) 0 (G) 180 (B) 0)

Set the pointer color for the RX Marker in the Fixed mode.

① Touch and select the color scale, and then rotate **(DIAL C)**.

Marker Color (Peak) (Default: (R) 238 (G) 17 (B) 34)

Set the pointer color for the Peak Marker.

① Touch and select the color scale, and then rotate **(DIAL C)**.

Waterfall Display (Default: ON)

Turn the Water fall display ON or OFF for the normal scope or Mini scope screens.

- OFF: Turns OFF the Waterfall display.
- ON: Turns ON the Waterfall display.

① In the Expanded scope screen, the Waterfall is always displayed.

Waterfall Speed (Default: Mid)

Select the Waterfall speed.

- Slow: Sets the waterfall speed to Slow.
- Mid: Sets the waterfall speed to Mid.
- Fast: Sets the waterfall speed to Fast.

Waterfall Size (Expand Screen) (Default: Mid)

Select the Waterfall height for the Expand scope screen.

- Small: The same height with the Normal scope screen, only the FFT scope expands.
- Mid: The Waterfall height expands at the same ratio with the FFT scope.
- Large: Only the Waterfall height expands.

Waterfall Peak Color Level (Default: Grid 8)

Select the signal level that the Waterfall displays a peak color. Higher signal levels are Red, Yellow, Green, Light-blue, Blue and Black, in that order.

- Option: Grid 1 ~ Grid 8

Waterfall Marker Auto-hide (Default: ON)

Set the Waterfall Marker Auto-hide function to ON or OFF.

- OFF: The marker in the Waterfall zone stays ON.
- ON: The marker in the Waterfall zone is hidden 2 seconds after you have stopped it in place.

Peak Excursion (Default: 6dB)

Set the difference of amplitude between the peak signal and nearby signals that determines what is considered a "peak."

- Settable range: 0 dB ~ +60 dB

Peak Threshold (Default: -70dB)

Set the threshold level for the Peak signal detection.

- Settable range: -80 dB ~ 0 dB

Peak Search Target Type (Default: Current)

Select the spectrum waveform type to search.

- Current: Search signals in the current waveform.
- Max Hold: Search signals in the peak hold waveform.

About the Function screen

On the Function screen, you can configure the settings of various functions for each receiving mode.

1. Push **[FUNCTION]** to open the Function screen.
2. Touch (or touch for 1 second) a function key.
 - Each touch turns the function ON or OFF.
 - Each long touch selects an option for the function.
- ① The usable functions differ, depending on the receiving mode.
3. Push **[EXIT]** to close the Function screen.

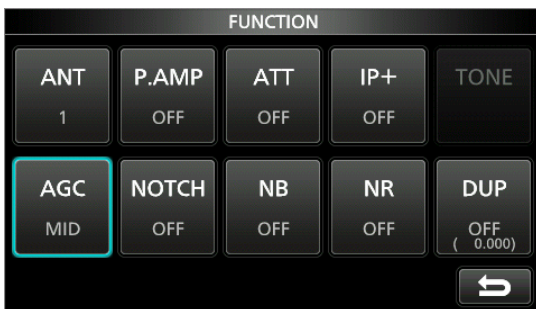

Function screen example (in the CW mode)

Preamplifier

A preamplifier is used when receiving weak signals.

① Each band memorizes the preamplifier setting.

- Push **[P.AMP]** on the Function screen.
- ① Each touch turns the preamp ON or OFF.

NOTE:

The gain of preamplifier is approximately 20 dB on the HF bands, 14 dB on the VHF and UHF bands. When you use the preamplifier while receiving a strong signal, the receiving signal may be distorted. In such case, turn OFF the preamplifier.

Attenuator

The Attenuator prevents a desired signal from becoming distorted when a very strong signal is near the frequency, or when a very strong electric field.

① Each band memorizes the Attenuator setting.

- Touch **[ATT]** on the Function screen, to turn ON the Attenuator.
- ① Each touch changes the attenuation between 10 dB (ATT10), 20 dB (ATT20), 30 dB (ATT30) and OFF (no indication).
- ① If a strong signal is received and **OVF** (Overflow) appears, reduce the RF gain or turn ON the attenuator until **OVF** disappears.

Selecting the antenna

You can use either ANT1, ANT2, or ANT3 for receiving below 30 MHz.

1. Rotate **(MAIN DIAL)** to set a frequency to below 30 MHz (10 kHz ~ 29.999999 MHz).
2. Touch the antenna connector indicator.
 - Each touch changes the selected antenna connector.
- ① Next time you set the same frequency, the same antenna connector is automatically selected.

AGC function control

The AGC (Automatic Gain Control) produces a constant audio output level, even when the received signal strength varies greatly.

The receiver has 3 preset AGC settings (time constants: FAST, MID and SLOW) for all modes except the FM and DIGITAL mode.

1. Select the operating mode. (Example: SSB)
2. Push **[FUNCTION]** to open the FUNCTION screen.
3. Touch **[AGC]** to select an AGC setting.
 - Each touch changes the attenuation between FAST ("AGC-F"), MID and SLOW.
 - ① The AGC is fixed to "FAST" in the FM, WFM or Digital mode.
4. To close the FUNCTION screen, **[EXIT]**.

You can change the preset AGC time constant:

1. On the FUNCTION screen, touch **[AGC]** for 1 second.
2. Touch either FAST, MID or SLOW.
3. Touch an AGC preset you want to change the time constant. (Example: MID)



AGC screen (in the SSB mode)

You can reset to the default settings by touching this key for 1 second.

4. Rotate **(MAIN DIAL)** to set the time constant.
- ① The adjustable time constants are described in the table below.
5. To close the AGC screen, push **[EXIT]**.

• Selectable AGC Time constant (unit: seconds)

Mode	Default	Adjustable time constant
SSB	0.3 (FAST)	OFF, 0.1, 0.2, 0.3, 0.5, 0.8, 1.2, 1.6, 2.0, 2.5, 3.0, 4.0, 5.0 or 6.0
	2.0 (MID)	
	6.0 (SLOW)	
CW/FSK	0.1 (FAST)	OFF, 0.1, 0.2, 0.3, 0.5, 0.8, 1.2, 1.6, 2.0, 2.5, 3.0, 4.0, 5.0 or 6.0
	0.5 (MID)	
	1.2 (SLOW)	
AM	3.0 (FAST)	OFF, 0.3, 0.5, 0.8, 1.2, 1.6, 2.0, 2.5, 3.0, 4.0, 5.0, 6.0, 7.0 or 8.0
	5.0 (MID)	
	7.0 (SLOW)	
FM/WFM/DIGITAL	0.1 (FAST)	Fixed

NOTE: When you are receiving weak signals, and a strong signal is momentarily received, the AGC function quickly reduces the receiver gain. When that signal disappears, the receiver may not receive the weak signal because of the AGC action. In that case, select FAST, or turn OFF the AGC function.

IP Plus function

The IP Plus function improves the Intermodulation Distortion (IMD) quality by optimizing the direct sampling system performance.

This function optimizes the Analog/Digital Converter (ADC) against the distortion when you receive a strong input signals. It also improves the Third-order Intercept Point (IP3) while minimizing the reduction of the receive sensitivity.

① Each band memorizes the ON/OFF setting.

- Touch [IP+] on the FUNCTION screen.
 - ① Each touch turns the IP Plus function ON or OFF.
 - ① Select ON to prioritize the IP quality, and select OFF to prioritize the receive sensitivity.

Notch Filter

The notch filter suppresses interference. Auto Notch automatically attenuates beat tones, tuning signals and so on.

The Manual Notch attenuates beat tones, tuning signals and so on by adjusting the notching width and frequency.

Auto Notch: Used in the SSB, AM and FM modes.
Manual Notch: Used in the SSB, CW, FSK and AM modes.

- Touch [NOTCH] on the FUNCTION screen.
 - Each touch changes between “AN (Auto Notch),” “MN (Manual Notch)” and OFF.
 - ① In the CW or FSK mode, only Manual Notch (MN) can be selected.
 - ① In the FM or DIGITAL mode, only Auto Notch (AN) can be selected.

◇ Setting the notching width and frequency

1. Touch [NOTCH] for 1 second.
 - ① The Notch setting menu is displayed.
2. Slowly rotate (DIAL C) to adjust the notching frequency on the POSITION scale.
3. Touch [WIDTH] to select the Manual Notch filter width from “WIDE,” “MID” or “NAR.”



NOTE: While adjusting, noise may be heard. This comes from the DSP unit and does not indicate an equipment malfunction.

Using the Digital Twin PBT

SSB, CW, FSK and AM modes

The Digital Twin PBT (Passband Tuning) electronically narrows the IF passband width by over wrapping the passband frequency ranges of 2 PBT filters (PBT1 and PBT2), to reject interference. The IC-R8600 uses DSP for the PBT function.

1. Push (DIAL C).
2. Touch [PBT1] or [PBT2].
3. Rotate (DIAL C) to adjust the passband width.
 - The current passband width (BW) and shift frequency (SFT) is displayed.
 - ① A dot is displayed right below the shift frequency indicates that the passband frequency is shifted.

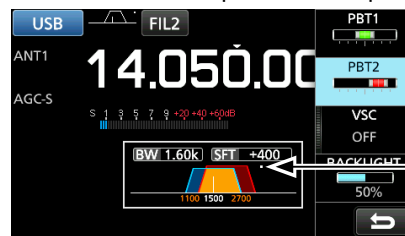

A dot is displayed when the filter frequency is shifted.

- To narrow the IF passband width, rotate (DIAL C) to shift the passband width in the opposite direction from each other.
 - To shift the pass band frequency range, match both the [PBT1] and [PBT2].
 - The PBT is adjustable in 50 Hz steps in the SSB, CW, and FSK modes, and 200 Hz in the AM mode. In this case, the center shift frequency changes in 25 Hz steps in the SSB, CW, and FSK modes, and 100 Hz in the AM mode.
 - Touch [PBT1] or [PBT2] for 1 second to clear the PBT setting.
4. Push (EXIT) to close the setting menu.

NOTE: While adjusting, you may hear noise. This comes from the DSP unit and does not indicate an equipment malfunction.

Selecting the digital IF filter

The IC-R8600 has 3 digital IF filter passband widths for each receive mode.

- Touch the filter icon several times to select FIL 1 (wide), FIL 2 (mid) or FIL 3 (narrow).

① Each touch changes the filter.

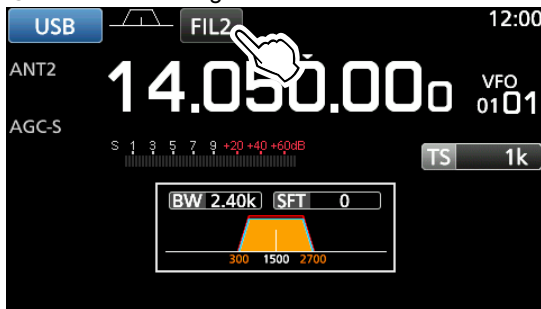

◇ Adjusting the passband width

1. Touch the filter icon for 1 second.
2. Touch [BW].
 - Selects the passband width mode.

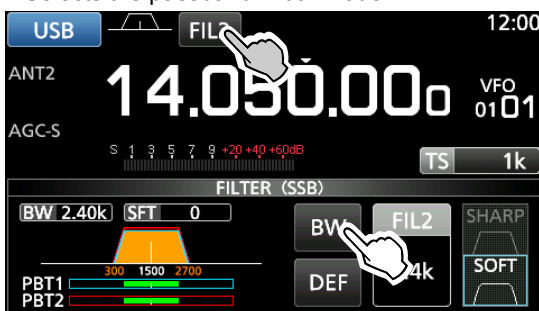

① You cannot change the passband width in the FM, WFM or DIGITAL modes.

3. Rotate **(MAIN DIAL)** to adjust the passband width.
 - ① When you change the passband width, the Twin PBT setting is reset to the center position.

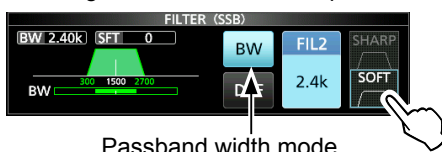

Passband width mode

4. In the SSB or CW mode, you can change the filter shape by touching [SHARP] or [SOFT].
 - ① See "Selecting the filter shape" to the right.
5. To close the FILTER screen, push **(EXIT)** several times.

[Receiving mode and the IF filter]

Mode	IF filter (default)	Selectable range (steps)
SSB	FIL 1 (3.0 kHz)	50 Hz to 500 Hz (50 Hz)/ 600 Hz to 3.6 kHz (100 Hz)
	FIL 2 (2.4 kHz)	
	FIL 3 (1.8 kHz)	
CW	FIL 1 (1.2 kHz)	50 Hz to 500 Hz (50 Hz)/ 600 Hz to 3.6 kHz (100 Hz)
	FIL 2 (500 Hz)	
	FIL 3 (250 Hz)	
FSK	FIL 1 (2.4 kHz)	50 Hz to 500 Hz (50 Hz) 600 Hz to 2.7 kHz (100 Hz)
	FIL 2 (500 Hz)	
	FIL 3 (250 Hz)	
AM S-AM	FIL 1 (9.0 kHz)	200 Hz to 10.0 kHz (200 Hz)
	FIL 2 (6.0 kHz)	
	FIL 3 (3.0 kHz)	
FM	FIL 1 (50 kHz)	Fixed
	FIL 2 (15 kHz)	
	FIL 3 (7.0 kHz)	
WFM	FIL 1 (200 kHz)	Fixed
D-STAR P25 NXDN-N	FIL 1 (15 kHz)	Fixed
	FIL 2 (10 kHz)	
	FIL 3 (7.0 kHz)	
dPMR NXDN-VN DCR	FIL 1 (10 kHz)	Fixed
	FIL 2 (7.0 kHz)	
	FIL 3 (5.0 kHz)	

◇ Selecting the filter shape

In the SSB or CW mode, you can independently set the DSP filter shape to soft or sharp for each operating mode.

SHARP

This selection is to emphasize the passband width of the filter. The filter has an almost ideal shape factor. Signals out of the passband are extremely filtered out and it gives you better audio quality.

SOFT

The filter shoulders are roundly formed as in analog filters. This decreases noise components in the high and low frequencies of the filter passband and increases the S/N ratio of the target signal. These characteristics play an effective role in picking up very weak signals. The filter shape is kept, and the sharpness of the bandpass is excellent.

Noise Blanker (NB)

SSB, CW, FSK and AM modes

The Noise blanker eliminates pulse-type noise such as the noise from car ignitions.

1. On the FUNCTION screen, touch [NB].
①Each touch turns the Noise Blanker function ON or OFF.
2. To change the NB level, depth or width, touch [NB] for 1 second.
• Turns ON the Noise Blanker and opens the NB menu.
3. Touch the adjusting item. (Example: DEPTH)
4. Rotate (DIAL C) to adjust the level.



NOTE: When using the Noise Blanker, received signals may be distorted if they are excessively strong or the noise is other than a pulse type. In that case, turn the OFF Noise Blanker, or shallow the DEPTH on the NB menu. See the description below for details.

Noise Blanker OFF

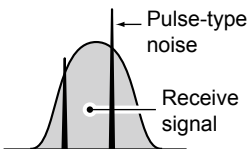

Noise Blanker ON

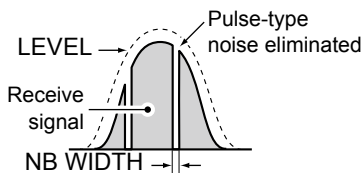

Noise Blanker ON (Not enough DEPTH)

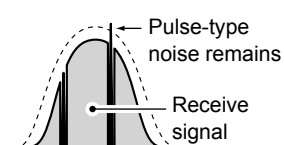

Noise Blanker ON (WIDTH set too wide)

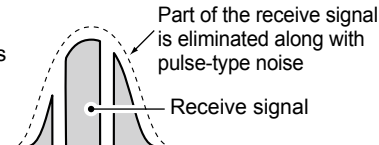

LEVEL (Default: 50%)

Set the Noise Blanker activation level to between 0 and 100%.

DEPTH (Default: 8)

Adjust the noise attenuation level between 1 and 10.

WIDTH (Default: 50)

Adjust the blanking duration time between 1 and 100.

Noise Reduction

The Noise Reduction function digitally reduces random noise components, and enhances desired signals that are buried in noise.

①The function is effective in the SSB, AM and CW modes.

1. On the FUNCTION screen, touch [NR].
①Each touch turns the Noise Reduction function ON or OFF.
2. To change the Noise Reduction level, touch [NR] for 1 second.
• Turns ON the Noise Reduction and opens the NR menu.
3. Set the Noise Reduction level to between 0 and 15.
• Adjust the Noise Reduction level to where noise is reduced and the received signal is not distorted.
①Set to a higher level to increase the reduction level, and a lower level to decrease it.

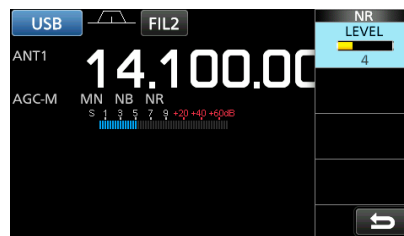

Duplex operation

You can receive a communication that uses different frequencies for transmitting and receiving (Duplex), by setting the offset frequency and shift direction.

1. On the FUNCTION screen, touch [DUP].
• Each touch changes between [DUP-], [DUP+] and [OFF].
2. To change the frequency offset or shift direction, touch [DUP] for 1 second.
3. Touch the numeric keys or rotate (DIAL C), to set the frequency offset.
• Settable range: 0.000 ~ 200.000 MHz (1 kHz step)

Offset frequency (When the Monitor function is ON.)



Touch to change the Shift direction

4. Hold down (DIAL B) to turn ON the Monitor function.
• The receive frequency shifts according to the set frequency offset and direction, while holding down (DIAL B).
• [DUP-] or [DUP+] blinks when the shifted frequency is out of receive frequency range.
• The frequency offset and direction is stored in each memory channel.
• When the frequency offset is set to 0.000 MHz, the receive frequency is not shifted.

AFC function

FM, WFM and DIGITAL modes

The AFC (Automatic Frequency Control) function tunes the receive frequency into the incoming signal.
 ① This function activates regardless of the squelch condition.
 ② In the WFM mode, the receive frequency may not tune to the center frequency.

1. Push **[DIAL C]**.



2. Touch **[AFC]**.
 - Each touch turns the AFC function ON or OFF.
3. To close the MENU screen, push **[EXIT]**.

Receiving in the CW mode

◇ Setting the CW pitch control

You can set the received CW audio pitch and the CW side tone without changing the operating frequency.

1. Push **[DIAL C]**.
2. Touch **[CW PITCH]**.
3. Rotate **[DIAL C]** to adjust the pitch.
 - Settable range: 300 ~ 900 Hz

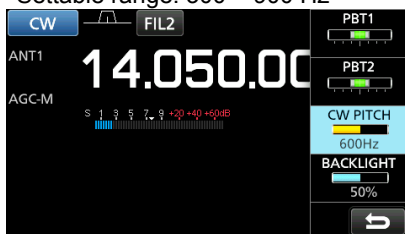

◇ About the CW Reverse mode

The CW-R (CW Reverse) mode reverses the receive Beat Frequency Oscillator (BFO).
 Use when interfering signals are near the desired signal and you want to reduce interference.

CW mode (LSB side) CW-R mode (USB side)

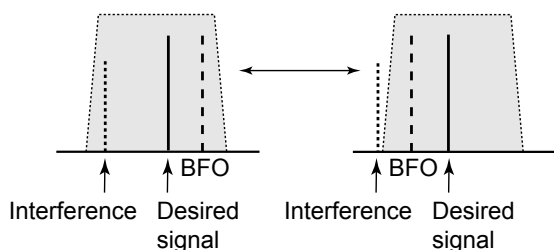

TIP: Reversing the carrier point

The carrier point of the CW mode is LSB by default. You can change it to USB in the "CW Normal Side" item of the OTHERS set screen. (p. 11-3)

[MENU] » **SET > Function > CW Normal Side**

Receiving FSK (RTTY) signal

◇ Decoded FSK data display

The IC-R8600 decodes FSK signals with a built-in decoder. The decoded characters are displayed on the FSK DECODE screen.

- Open the FSK DECODE screen in the FSK mode.

[MENU] » **DECODE**

Tuning indicator

Decoding baud rate

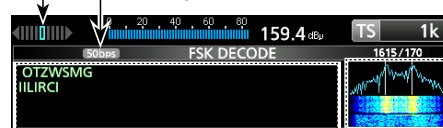

← FFT scope

When tuned into an FSK signal, the decoded characters are displayed here.

◇ Decoding FSK signal

1. Set the Mark frequency and Shift width on the FUNCTION screen. (p. 5-7)
2. Rotate **[MAIN DIAL]** to adjust the waveform on the FFT scope screen.

① Information

- Aim for a symmetrical wave form, and be sure the peak points align with the mark and shift frequency lines on the FFT scope screen.
- The S-meter displays the received signal strength, when a signal is received.
- If you cannot decode correctly, try the FSK-R (Reverse) mode.
- Tune to where both "◀" and "▶" are displayed in the tuning indicator.
- The Mark and Shift frequency differ, depending on the frequency band.

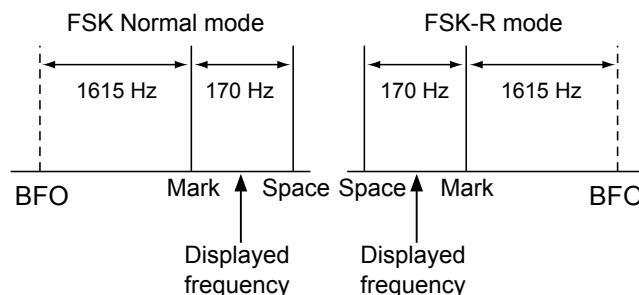

- ① On the amateur radio band, set the Mark frequency to 2125 Hz and the shift frequency to 170 Hz in the FSK-R mode.

Receiving FSK (RTTY) signal (Continued)

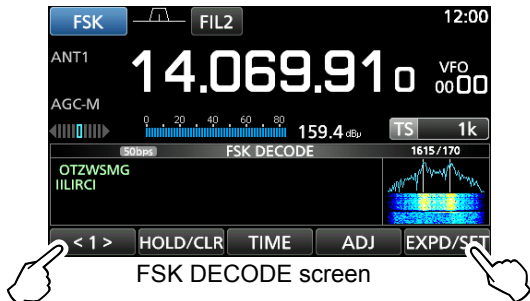

- Touch <1> to switch to Menu 2.



Touch for 1 second to open the FSK DECODE SET screen (p. 5-8)

[Function Menu Items]

Key	Action	
<1> <2>	Toggles the Function menu between Menu 1 and Menu 2.	
HOLD/CLR	Touch	Turns the Hold function ON or OFF. ① "HOLD" is displayed, and the FSK DECODE screen stops.
	Touch for 1 second	Clears the displayed characters. ① While the Hold function is ON, this clears the characters and cancels the Hold function.
TIME	Touch to insert a time stamp into the decoded contents.	
ADJ	Touch to open the THRESHOLD screen to set the threshold level.	
DEF	Touch for 1 second to reset to the default threshold level.	
EXPD/SET	Touch	Selects the Expanded or Normal screen.
	Touch for 1 second	Opens the FSK DECODE SET screen.
BAUD	Touch to toggle the FSK decoding baud rate between 45 bps and 50 bps.	
LOG	Opens the FSK DECODE LOG screen. ① Starts/Stops logging or selects the file type.	
LOG VIEW	Opens the FSK DECODE LOG VIEW screen. ① You can check the saved log files.	

◇ Turning ON the FSK log

Turn ON the FSK log to save the received FSK signal records onto an SD card (user supplied).

① Insert an SD card before attempting to save logs.

1. Open the FSK DECODE LOG screen in the FSK mode.



2. Select "Decode Log."



3. Select "ON."

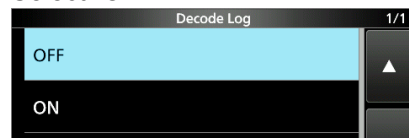

4. Push EXIT.

• "●" is displayed on the FSK DECODE screen when the Decode Log item is set to "ON."



5. To turn OFF the FSK log, select "OFF" in step 3.

① Information:

In step 2 in the above procedure, you can select the file type to save a log onto an SD card from Text and HTML (default: Text).

① You cannot change the file type while logging.

TIP: How to reset to the default setting

Touching the item or its option for 1 second displays the Quick menu, and then touch "Default" to reset to the default setting.

Receiving FSK (RTTY) signal (Continued)

◇ Viewing the FSK log contents

You can check the FSK log contents saved on an SD card.

1. Open the FSK DECODE LOG VIEW screen in the FSK mode.

MENU » **DECODE > <1> > LOG VIEW**

2. Select the desired log file to view.
 - ① The file with “●” is currently logging. You cannot check the log contents.
 - ② To close the FSK DECODE screen, push **EXIT** several times.

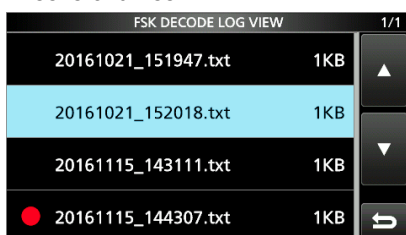

FSK DECODE LOG VIEW screen

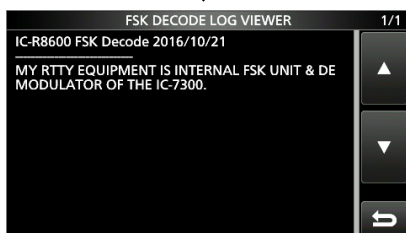

Example of a log saved in the text format.

◇ Twin Peak Filter

The Twin Peak Filter (TPF) changes the audio frequency response by boosting the mark and space frequencies for better reception of FSK signals.

1. While in the FSK mode, push **DIAL C**.
2. Touch [TPF].
 - Each touch turns the function ON or OFF.

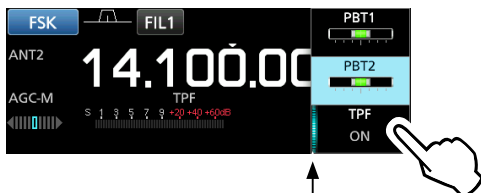

Lights while the TPF is ON

3. To close the MENU screen, push **EXIT**.

NOTE: When you are using the Twin Peak Filter, the received audio output may increase. This is not a malfunction.

◇ FSK tone and shift setting

You can change the FSK RX frequency, tone and shift frequencies, on the [FSK TONE/SHIFT] screen.

1. Touch [TONE/SHIFT] on the function screen.
2. Touch the desired item.
 - (Example: FSK RX frequency)



The FSK TONE/SHIFT screen

3. Select the desired option.
 - (Example: Mark (Space))

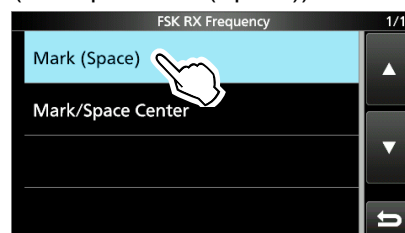

4. To close the FSK TONE/SHIFT screen, push **EXIT** several times.

FSK RX Frequency (Default: Mark/Space Center)

Selects the FSK RX frequency.

- Mark (Space):
Displays the higher frequency in the Mark or Space frequency.
- Mark/Space Center:
Displays the center frequency between the Mark and Space frequency.

FSK Tone Frequency (Default: 1615)

Selects the FSK mark frequency.

- Options: 1275, 1500, 1615 or 2125 (Hz)

FSK Shift Width (Default: 170)

Selects the FSK shift width between the Mark and Space frequencies.

- Options: 170, 200, 425, 800 or 850 (Hz)

Receiving FSK (RTTY) signal (Continued)

◇ About the FSK DECODE SET screen

You can change the settings related to FSK signal decoding.

1. Touch [DECODE] on the MENU screen.
2. Touch [EXPD/SET] for 1 second.

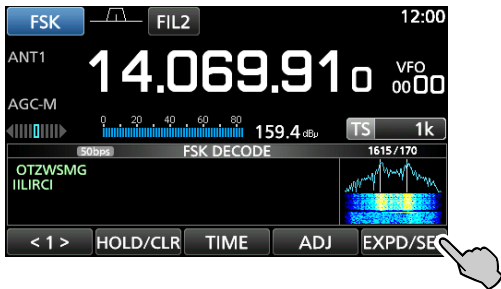

3. Rotate **(DIAL C)** and touch the desired item. (Example: FFT Scope Averaging)

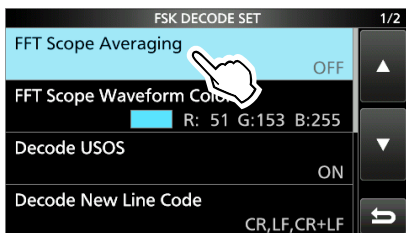

4. Rotate **(DIAL C)** and touch the desired option. (Example: 2)

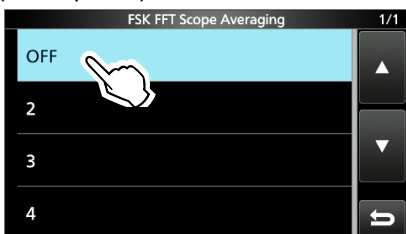

5. To close the FSK DECODE screen, push **(EXIT)** several times.

TIP: How to reset to the default setting
Touching the item or its option for 1 second displays the Quick menu, and then touch "Default" to reset to the default setting.

FFT Scope Averaging (Default: OFF)

Set the FFT scope waveform averaging function (noise reduction by averaging the waveform) to between 2 and 4 or to OFF.

- ① Set the default or smaller number for tuning on FFT scope waveform.

FFT Scope Waveform Color (Default: R: 51, G: 153, B: 255)

Set the color of the FFT scope waveform.

- ① Touch and select the R (Red), G (Green) or B (Blue) scale, and then rotate **(DIAL C)** to adjust the ratio to between 0 and 255.
- ② The color is displayed in the box above the RGB scale.

Decode USOS (Default: ON)

Turn the Letter Code Decoding function ON or OFF.

- ON: Decodes as a letter code after receiving a "space."
- OFF: Decodes as a character code.
- ① USOS stands for UnShift On Space function.

Decode New Line Code (Default: CR, LF, CR+LF)

Select the FSK decoder new line code.

- CR,LF,CR+LF: Makes a new line with any codes.
- CR+LF: Makes a new line with only CR+LF code.
- ① CR stands for Carriage Return, and LF stands for Line Feed.

Time Stamp (Time) (Default: Local)

Select the local time or UTC time to store on the FSK receive log.

- Local: In local time
- UTC: In UTC time

Time Stamp (Frequency) (Default: ON)

Select whether or not to store the frequency data on the FSK receive log.

- OFF: Does not store
- ON: Stores the frequency data

Font Color (Receive) (Default: R: 128, G: 255, B: 128)

Set the text font color for received characters.

- ① Touch and select the R (Red), G (Green) or B (Blue) scale, and then rotate **(DIAL C)** to adjust the ratio to between 0 and 255.
- ② The color is displayed in the box above the RGB scale.

Font Color (Time Stamp) (Default: R: 0, G: 155, B: 189)

Set the text font color for Time Stamp characters.

- ① Touch and select the R (Red), G (Green) or B (Blue) scale, and then rotate **(DIAL C)** to adjust the ratio to between 0 and 255.
- ② The color is displayed in the box above the RGB scale.

Tone squelch function

FM mode

The Tone squelch opens only when you receive a signal that includes a matching subaudible tone.

① Refer to page 9-11 for Tone scan or Code scan.

1. Touch [TONE] on the FUNCTION screen.
 - Each touch changes between [TSQL], [DTCS] and [OFF].
2. To change the Tone frequency or DTCS code, touch [TONE] for 1 second.
 - Opens the TONE FREQUENCY screen.
3. Touch [T-SQL TONE] or [DTCS CODE], then rotate (MAIN DIAL), to change the frequency or code.
 - Touch [POL] to toggle the DTCS polarity.
 - The settings are stored in each memory channel.

Toggles the polarity (DTCS) Starts or stops a Tone scan (p. 9-11)

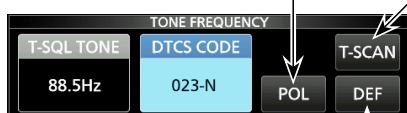

Touch for 1 second to reset to the default setting.

4. To close the TONE FREQUENCY screen, push [EXIT].

• Selectable tone frequencies (Hz)

67.0	88.5	114.8	151.4	177.3	203.5	250.3
69.3	91.5	118.8	156.7	179.9	206.5	254.1
71.9	94.8	123.0	159.8	183.5	210.7	150.0
74.4	97.4	127.3	162.2	186.2	218.1	
77.0	100.0	131.8	165.5	189.9	225.7	
79.7	103.5	136.5	167.9	192.8	229.1	
82.5	107.2	141.3	171.3	196.6	233.6	
85.4	110.9	146.2	173.8	199.5	241.8	

• Selectable DTCS codes

023	054	125	165	245	274	356	445	506	627	732
025	065	131	172	246	306	364	446	516	631	734
026	071	132	174	251	311	365	452	523	632	743
031	072	134	205	252	315	371	454	526	654	754
032	073	143	212	255	325	411	455	532	662	
036	074	145	223	261	331	412	462	546	664	
043	114	152	225	263	332	413	464	565	703	
047	115	155	226	265	343	423	465	606	712	
051	116	156	243	266	346	431	466	612	723	
053	122	162	244	271	351	432	503	624	731	

D.SQL (Digital Squelch) function

◇ Digital Code Squelch

D-STAR mode

The squelch opens only when you receive a D-STAR signal that includes a matching CSQL (Code Squelch).

• Settable range: 00 ~ 99

1. Touch [D.SQL] on the FUNCTION screen.
 - Each touch turns the function ON or OFF.
2. To change the digital code, touch [D.SQL] for 1 second.
 - Opens the DIGITAL SQL (D-STAR) screen.
3. Rotate (MAIN DIAL) to set the code.
 - ① The setting is stored in each memory channel.

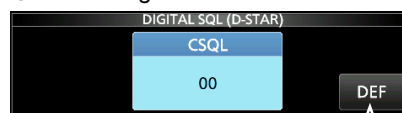

Touch for 1 second to reset to the default setting.

① Information

When receiving the data communication signal, the data is restored, regardless of the digital code setting.

◇ Network Access Code (NAC)

P25 mode

The squelch opens only when you receive an APCO P25 signal that includes a matching NAC.

• Settable range: 000 ~ FFF (in hexadecimal)

1. Touch [D.SQL] on the FUNCTION screen.
 - Each touch turns the function ON or OFF.
2. To change the NAC, touch [D.SQL] for 1 second.
 - Opens the DIGITAL SQL (P25) screen.
3. Rotate (MAIN DIAL) to set the code.
 - Touch [EDIT] to enter using the keypad.
 - ① The setting is stored in each memory channel.

Enter using the keypad

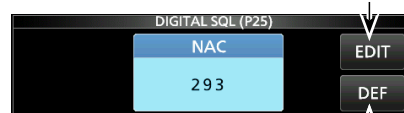

Resets to the default setting.

D.SQL (Digital Squelch) (Continued)

◇ Group Code (COM ID) and CC
dPMR mode

The squelch opens only when you receive a dPMR signal that includes a matching COM ID (Common ID) or CC.
• Settable range: 1 ~ 255 (COM ID), 0 ~ 63 (CC)

1. Touch [D.SQL] on the FUNCTION screen.
• Each touch changes between [COM ID], [CC] or [OFF].
2. To change the COM ID or CC, touch [D.SQL] for 1 second.
• Opens the DIGITAL SQL (dPMR) screen.
3. Touch [COM ID] or [CC] then rotate (MAIN DIAL) to set the ID or code.
① The settings are stored in each memory channel.

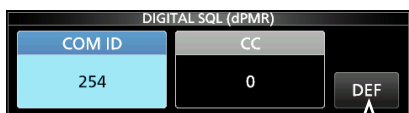

Touch for 1 second to reset to the default setting.

◇ Radio Access Number (RAN)
NXDN-vN and NXDN-n modes

The squelch opens only when you receive a NXDN signal that includes a matching RAN.
• Settable range: 0 ~ 63

1. Touch [D.SQL] on the FUNCTION screen.
• Each touch turns the function ON or OFF.
2. To change the number, touch [D.SQL] for 1 second.
• Opens the DIGITAL SQL (NXDN) screen.
3. Rotate (MAIN DIAL) to set RAN.
① The setting is stored in each memory channel.

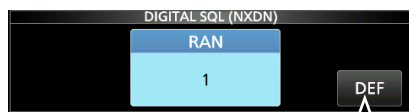

Touch for 1 second to reset to the default setting.

◇ User Code (UC)
DCR mode

The squelch opens only when you receive a DCR signal that includes a matching UC.
• Settable range: 1 ~ 511

1. Touch [D.SQL] on the FUNCTION screen.
• Each touch turns the function ON or OFF.
2. To change the number, touch [D.SQL] for 1 second.
• Opens the DIGITAL SQL (DCR) screen.
3. Rotate (MAIN DIAL) to set UC.
① The setting is stored in each memory channel.

Descrambler function

dPMR mode

You can descramble the scrambled dPMR (Tire2) communication by entering the appropriate key.
• Settable range: 1 ~ 32767

1. Touch [SCRAM] on the FUNCTION screen.
• Each touch turns the function ON or OFF.
2. To change the descramble key, touch [SCRAM] for 1 second.
• Opens the SCRAMBLER (dPMR) screen.
3. Rotate (MAIN DIAL) to set the key.
• Touch [EDIT] to enter using the keypad.
① The setting is stored in each memory channel.

Enter using the keypad

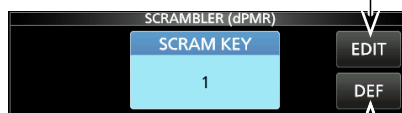

Resets to the default setting.

Decryption function

NXDN-vN, NXDN-n and DCR modes

You can decrypt the encrypted NXDN or DCR communication by entering the appropriate key.
• Settable range: 1 ~ 32767

1. Touch [ENCRYP] on the FUNCTION screen.
• Each touch turns the function ON or OFF.
2. To change the decrypting key, touch [ENCRYP] for 1 second.
• Opens the ENCRYPTION screen.
3. Rotate (MAIN DIAL) to set the key.
• Touch [EDIT] to enter using the keypad.
① The setting is stored in each memory channel.

Enter using the keypad

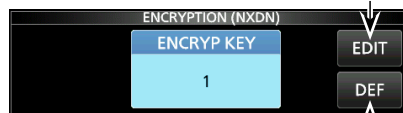

ENCRYPTION KEY screen (Example: NXDN)

Resets to the default setting.

Receive history log

DIGITAL mode

When a digital is received, the call signs, IDs and so on are stored in the RX history. Up to 50 log entries can be stored.

- When you receive the 51th call, the oldest history will be deleted.
- Even if the receiver is turned OFF, the RX record will not be deleted.

1. Touch [HISTORY] on the MENU screen.

MENU » **HISTORY**

2. Rotate **(DIAL C)** then touch a log to view.

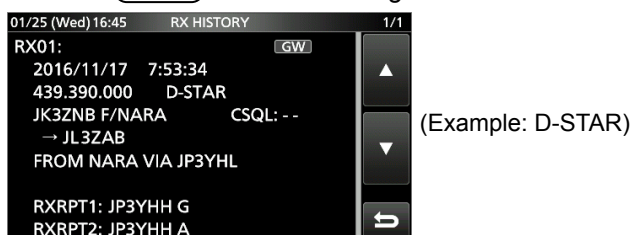

3. To close the RX HISTORY screen, push **EXIT**.

[RX history items]

• Common

Frequency	Frequency
Mode	Signal mode
Time	Date and time the call was received.

• D-STAR

Caller call sign	The call sign of the caller station.
Called call sign	The call sign of the called station.
Message	Any message included in the received call, if programmed.
RXRPT1 (FROM repeater)	The call sign of the repeater that was accessed by the caller station.
RXRPT2 (TO repeater)	The call sign of the repeater you received the call from.
CSQL	Digital squelch code.

• P25 (Phase 1)

Caller ID	The ID of the caller station.
Called ID	The ID of the called station.
NAC	Network Access Code
Type of call	ALL (All), GRP (Group) or IND (Individual)

• dPMR (Tier1)

COM ID	—
--------	---

• dPMR (Tier2)

Caller ID	The ID of the caller station.
Called ID	The ID of the called station.
CC	—
Type of call	All (Displayed only if the signal is an All call.)

• NXDN-vN, NXDN-N and DCR

Caller ID	The ID of the caller station.
Called ID	The ID of the called station.
RAN/UC*	Radio Access Number/User Code*
Type of call	ALL (All), GRP (Group) or IND (Individual)

*For DCR.

- ① If the received is not an Individual call or the DCR transceiver manufacture is not Icom, only User Code is displayed.

Screen Capture function

You can capture the receiver screen onto an SD card.

- ① Some displays cannot be captured.

◇ Capturing a screen

1. Open the “Screen Capture [POWER] Switch” screen.

MENU » **SET > Function > Screen Capture [POWER] Switch**

2. Touch “ON.”
3. To close the Screen Capture [POWER] Switch screen, push **EXIT** several times.
4. Arrange the screen you want to capture.
5. Push **POWER** to capture the screen.
 - The captured screen is saved onto the SD card.
 - If there is
 - ① You can change the picture file format. (p. 11-4)

◇ Viewing the captured screen

1. Open the SCREEN CAPTURE VIEW screen.

MENU » **SET > SD Card > Screen Capture View**

- The capture list is displayed.
2. Rotate and push **(DIAL C)** to select and open the desired screen capture.

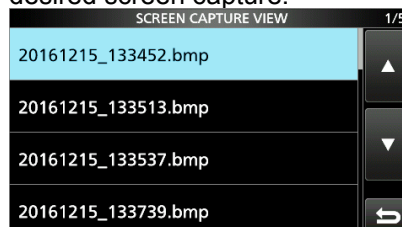

- The selected screen capture is displayed.
 - ① While a screen capture is displayed, you can scroll through all the screen captures by rotating **(DIAL C)**.
3. Push **EXIT** to close and return to the SCREEN CAPTURE VIEW screen.

Other options in the capture list

1. While the capture list is displayed, push **QUICK** to open the QUICK MENU.
2. Select the desired option.

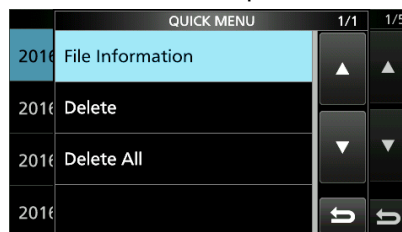

- **File Information:** Displays the name, size, and date of the selected screen capture.
- **Delete:** On the confirmation dialog, select [YES] to delete.
- **Delete All:** On the confirmation dialog, select [YES] to delete all.

Recording

You can record the received audio onto an SD card.

◇ Quick recording

You can quickly start to record the receive audio.

1. Push **QUICK**.
2. Touch [**<<REC Start>>**].
 - Starts recording and “Recording started.” is briefly displayed and the SD card LED starts to blink.

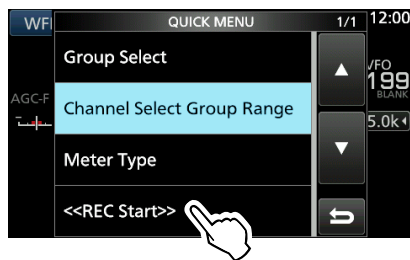

3. Push **QUICK** again.
4. Touch “<<REC Stop>>.”
 - Stops recording and “Recording stopped.” is briefly displayed.

◇ Normal recording

You can start to record after you configure the recording settings.

1. Open the **RECORD** screen.
MENU » **RECORD**
2. If you want to change the recorder setting, touch [Recorder Set]. (p. 6-4)
3. Touch “<<REC Start>>.”



- Recording starts.
4. Touch “<<REC Stop>>.”
 - Stops recording and “Recording stopped.” is briefly displayed.
 5. To close the RX RECORDER screen, push **EXIT**.

① Information: Record indication

- While recording:

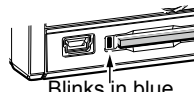

- While the recording is paused:



Playing back

1. Open the **PLAY FILES** screen.
MENU » **RECORD** > **Play Files**
2. Select a folder that contains the file you want to playback.

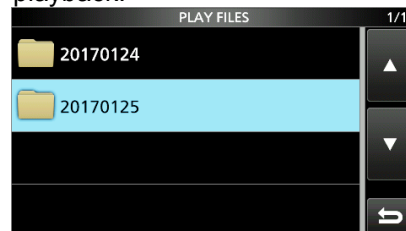

- The file list is displayed.

3. Select the desired file.
 - Starts a playback.
 - ① Playback continues to the next file, and stops when the last file in the folder is played back.

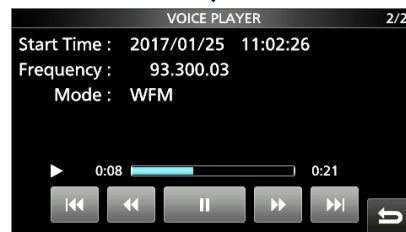
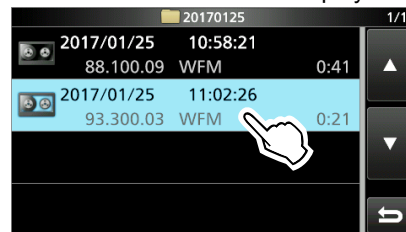









4. To close the **PLAY FILES** screen, push **EXIT** several times.

NOTE:

- An SD card (user supplied) is required.
- As the default setting, the recording is paused while the squelch is closed, and resumes when a signal is received. You can continue recording regardless of the signal presence. (p. 6-4)
- If your SD card does not have an "IC-R8600" folder, back up any data on the SD card, insert it in the receiver's card slot and then format it using the built-in format function. See “Formatting an SD card” (p. 7-2) for details.
- Once the recording starts, it continues, even if the receiver is turned OFF and ON again.
- The recording continues until you touch <<REC Stop>> or the free space on the SD card has run out.
- When the recording file's content becomes 2 GB, the receiver continues to record, but to a new file.

Operation while playing back

Operations on the Playback screen.

Key	Operation
	Touch to play the previous file. ① If there are other files in the folder, while the oldest file is playing back, touch this key to start playing the beginning of the file.
	Touch to play the next file. ① If there are other files in the folder, while the most recent file is playing back, touch this key to stop the playback.
	Touch to rewind to the skip time point. (Default: 10 seconds) ① If you touch this key within the first 1 second of the file, the end of the previously recorded file will play back.
	Touch to fast forward to the skip time point. (Default: 10 seconds)
	Touch to pause while playing. ①  is displayed while pausing. ② To cancel the pausing, touch  .
	Touch to playback the file. ①  is displayed while pausing.

Playing back on a PC

You can also playback on a PC.

① The recorded information (frequency, date, and so on) is not displayed.

1. Insert the SD card into your PC's SD card slot.

IC-R8600

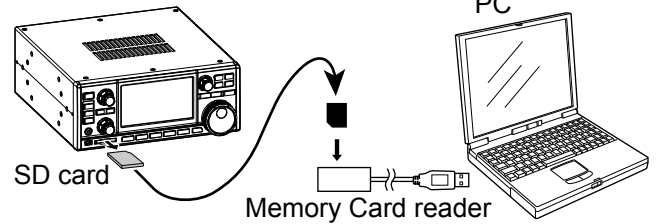

2. Double-click the "Voice" folder.

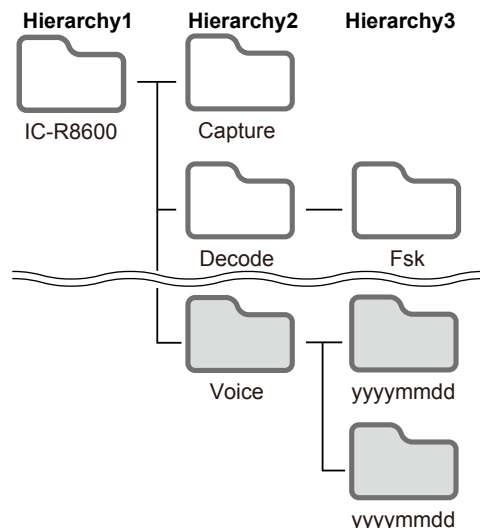

3. Double-click the folder where the file you want to playback is saved.
4. Double-click the file to playback.

NOTE:

- The operations while playing back may differ, depending on the application. Refer to the application's instruction manual for details.
- When the file does not playback, even if you double click the file, download an appropriate software application. (Example: Windows Media® Player)

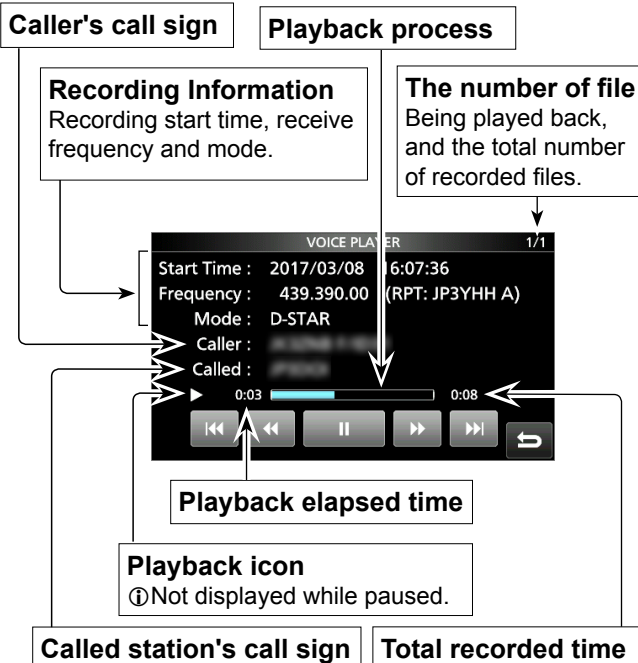

Checking the file information

The IC-R8600 can display the recorded file's operating frequency, operating mode, date, and so on.

1. Open the PLAY FILES screen.
MENU » **RECORD > Play Files**
2. Select a folder that contains the file you want to check.

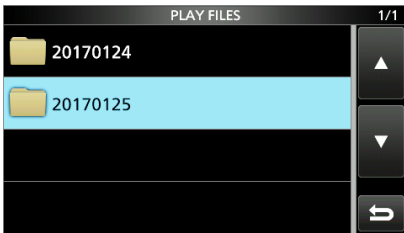

- The file list is displayed.
- ① Touch a folder for 1 second to check the folder information.

3. Touch the file you want to check for 1 second.

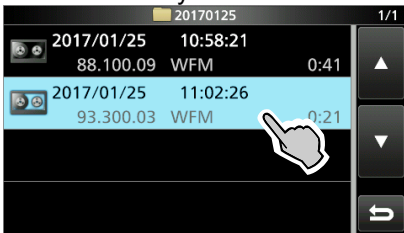

- The QUICK MENU screen opens.

4. Touch "File Information."

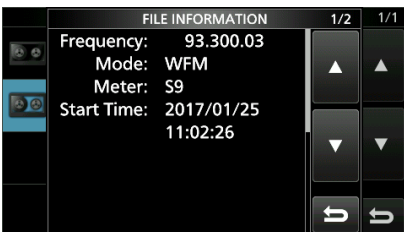
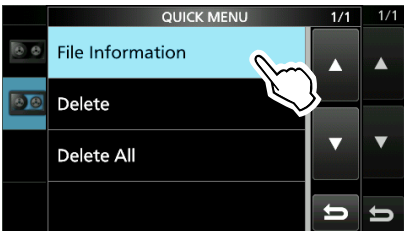

5. To close the PLAY FILES screen, push **EXIT** several times.

Deleting a file

You can delete the recorded audio file.

1. Open the PLAY FILES screen.
MENU » **RECORD > Play Files**
2. Select a folder that contains the file you want to delete.

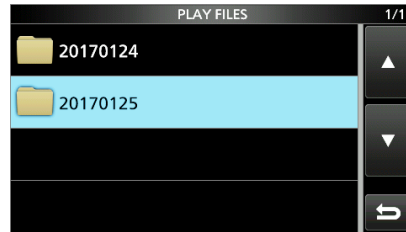

- The file list is displayed.

3. Touch the desired file to delete for 1 second.

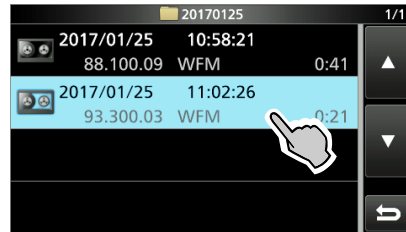

- The QUICK MENU screen opens.

4. Touch "Delete."
- Touch "Delete All" to delete all files in the folder.

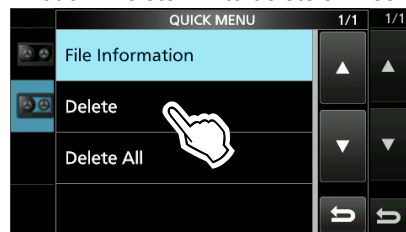

5. Touch [YES] on the confirmation dialogue.

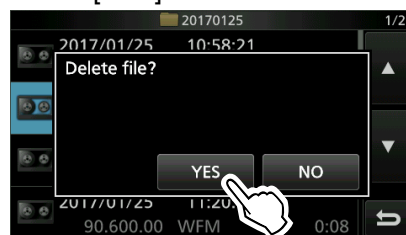

- The selected file is deleted.

6. To close the PLAY FILES screen, push **EXIT** several times.

Deleting a folder

You can delete the recorded audio folder.

NOTE: All the files in the folder are also deleted.

1. Open the PLAY FILES screen.
MENU » **RECORD > Play Files**
2. Touch the folder to delete for 1 second.

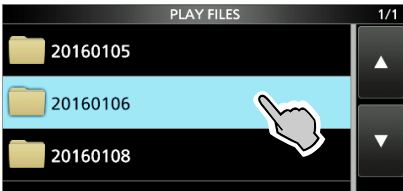

3. Touch "Delete."
• Touch "Delete All Folders" to delete all folders at one time.
4. Touch [YES] on the confirmation dialogue.
• The selected folder is deleted.

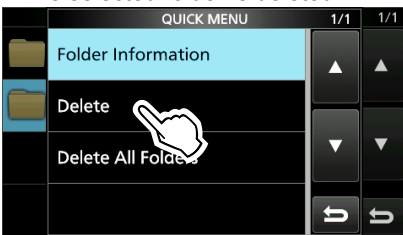

5. To close the PLAY FILES screen, push **EXIT** several times.

PLAYER SET screen

You can change the fast forward or rewind skip time in the PLAYER SET screen.

1. Open the RX RECORDER screen.
MENU » **RECORD**

2. Select "Player Set."

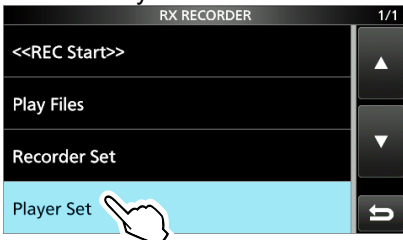

3. Touch "Skip Time."

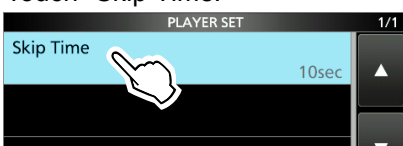

4. Select an option.
5. To close the RECORDER SET screen, push **EXIT** several times.

RECORDER SET screen

You can change the RECORDER SET settings.

1. Open the RX RECORDER screen.
MENU » **RECORD**
2. Select "Recorder Set."

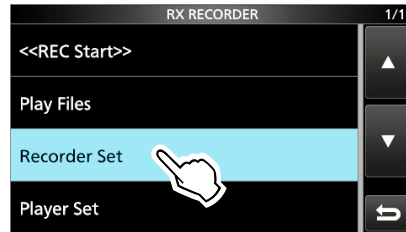

3. Select an item.

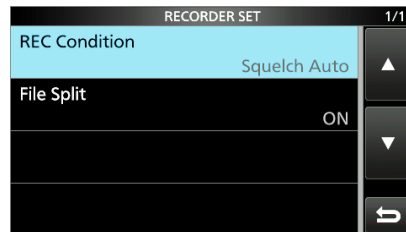

4. Select the desired option or value.
5. To close the RECORDER SET screen, push **EXIT** several times.

REC Condition (Default: Squelch Auto)

Select the recording condition for receive.

- Always: Records even if no signal is received.
- Squelch Auto: Records only when the squelch opens.
(The recording will be paused when the squelch closes while recording.)

File Split (Default: ON)

Turn the File Split function ON or OFF.

- OFF: The audio is continuously recorded into the file even if the squelch status changes between open and closed.
When the recording file's size becomes 2 GB, the IC-R8600 continues to record, but to a new file.
- ON: While recording, and if the squelch status changes between open and closed, a new file is automatically created in the same folder, and the audio is saved into the new one.

TIP: How to reset to the default setting

Touching the item or its option for 1 second displays the Quick menu, and then touch "Default" to reset to the default setting.

About the SD card

The SD and SDHC cards are not supplied by Icom. User supplied.

You can use an SD card of up to 2 GB, or an SDHC of up to 32 GB. Icom has checked the compatibility with the following SD and SDHC cards.

(As of October 2017)

- Brand: SanDisk®
- Type: SD (2 GB) and SDHC (4, 8, 16 and 32 GB)
- ① The above list does not guarantee the card's performance.
- ① Throughout the rest of this document, the SD card and an SDHC card are simply called the SD card or the card.

NOTE:

- Before using the SD card, thoroughly read the card's instructions.
- If you do any of the following, the card data may be corrupted or deleted.
 - You remove the card from the receiver while the card is being accessed.
 - A power failure occurs or the power cable is disconnected while the card is being accessed.
 - You drop, impact or vibrate the card.
- Do not touch the contacts of the card.
- The receiver takes a longer time to recognize a large capacity card.
- The card will get warm if continuously used for a long period of time.
- The card has a certain lifetime, so data reading or writing may not be possible after using it for a long period. When reading or writing data is impossible, the card's lifetime has ended. In that case, use a new one. We recommend you make a separate backup file of the important data onto your PC.
- Icom will not be responsible for any damage caused by data corruption of a card.

◇ SD card's folder contents

The following folders are created in the SD card.

- ① All folders are contained in this folder.
- ② The captured screen data ('.png' or '.bmp').
- ③ The FSK decode log folder is created.
- ④ The received FSK decode log data ('.txt' or '.html').
- ⑤ The receive history log data ('.csv').
- ⑥ The receiver's setting data ('.icf').
- ⑦ The recorded audio data folders are created.
- ⑧ Recorded audio files ('.wav').
The folder name is automatically created in the following format: yyyymmdd (yyy:Year, mm:month, dd:day)

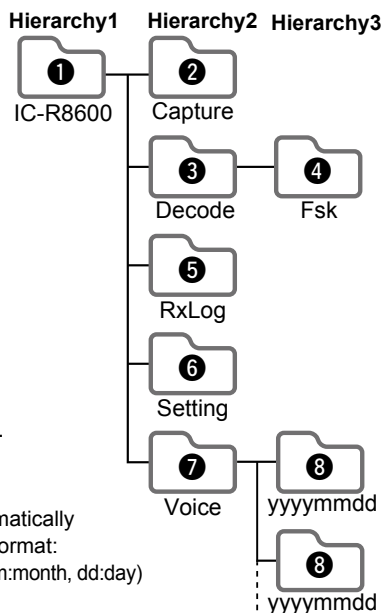

Saving data onto the SD card

You can save the following data onto the card:

- Data settings of the receiver
Memory channel contents saved in the receiver.
- Communication contents
The recorded audio.
- Communication log
The receive history log.
- FSK (RTTY) decode log
The received FSK decode history log.
- Captured screens

TIP: Icom recommends that you save the receiver's factory default data for backup.

Inserting or removing the SD card

NOTE: Format all SD cards to be used with the receiver with the built-in Format function. Format, even preformatted cards for PCs or other uses. (p. 7-2)

◇ Inserting

Insert the card into the slot until it locks in place, and makes a 'click' sound.

- Displays the SD card icon when the SD card is inserted.
- ① Be sure of the card orientation.

◇ Removing (While the receiver is OFF)

Push in the SD card until a click sounds.

- The card is unlocked, and you can pull it out.
- ① If you remove the SD card while the receiver's power is ON, be sure to unmount it.

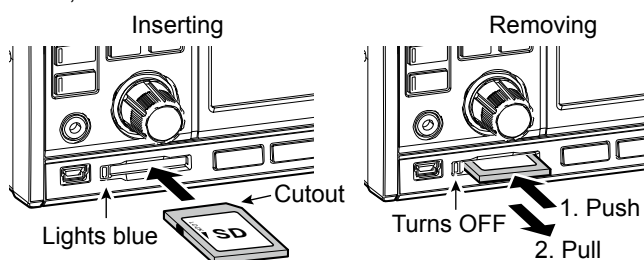

◇ Removing (While the receiver is ON)

Proceed the unmount as shown below, otherwise the data may be corrupted or deleted.

1. Open the SD CARD screen.
2. Touch [Unmount].

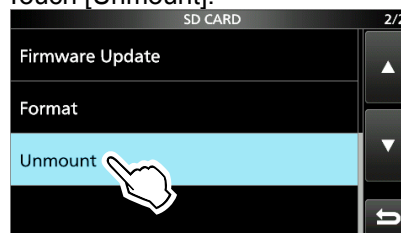

- Unmount confirmation dialogue appears.
- 3. Touch [YES].
• "Unmount is completed." is displayed.
- 4. Push the SD card, then pull it out.

Formatting an SD card

Before using an SD card with the receiver, be sure to format all SD cards with the built-in Format function. This creates a special folder on the card that you need for operations like updating the firmware. Format all cards, including a brand new SD card, and even preformatted cards for PCs or other uses.

NOTE: Formatting a card erases all its data. Before formatting any used card, back up its data onto your PC.

IMPORTANT: Even if you format an SD card, some data may remain in the card. When you dispose the card, be sure to physically destroy it to avoid unauthorized access to any data that remains.

1. Insert an SD card into the card slot.
2. Open the SD CARD set screen.

MENU » **SET > SD Card**

3. Touch [Format].

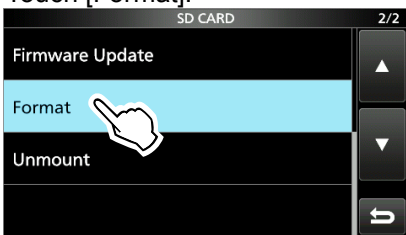

- The format confirmation dialogue appears.
4. Touch [YES] to start formatting.
 - After formatting, returns to the SD CARD screen.
 5. To close the SD CARD screen, push **EXIT** several times.

Saving in the old format

After you update the receiver's firmware, the "Save Form" item will be added on the SD CARD screen.

MENU » **SET > SD Card > Save Form**

With this item, you can select the firmware version to save the setting data onto an SD card. (p. 11-10) You can write the setting file that is saved in an earlier version to an earlier firmware version IC-R8600.

- ① Depending on the receiver's firmware version, this item may not be displayed. In that case, save the file in the current version.
- ① See page 13-1 for details of the firmware update.

Saving the setting data

You can save the Memory channels and the receiver's settings onto an SD card.

1. Insert an SD card into the card slot.
2. Open the SAVE SETTING screen.

MENU » **SET > SD Card > Save Setting**

3. Select "<<New File>>."

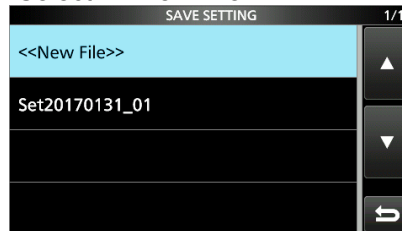

SAVE SETTING screen

- ① The file name is automatically set in the following format: Setyyyyymmdd_xx (yyyy: Year, mm: month, dd: day, xx: serial number)

TIP: After you update the receiver's firmware, the "Save Form" item will be added on the SD CARD set screen. If this item is set to the earlier firmware version, the confirmation window is displayed. When you want to save the data in the earlier firmware version, touch [YES].

4. Touch [ENT].

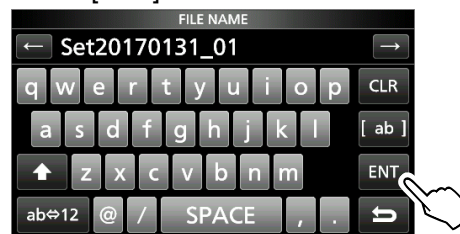

5. Touch [YES].

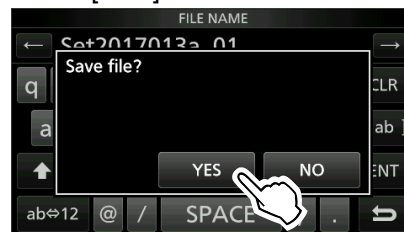

- Saves the data settings.
 - ① While saving to the card, the SD card icon blinks.
 - ① After saving, returns to the SD CARD screen.
6. To close the SD CARD screen, push **EXIT** several times.

Loading the data files

You can load the Memory channels and receiver's settings from the card to the receiver.

TIP: Saving the current data is recommended before loading other data into the receiver.

1. Open the LOAD SETTING screen.
MENU » **SET > SD Card > Load Setting**

2. Select the file you want to load.

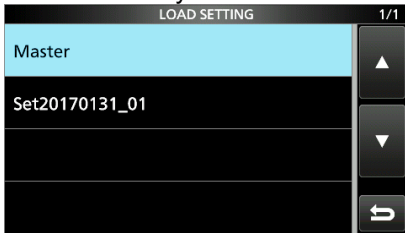

LOAD SETTING screen

3. Select a loading option.
① Choose "ALL" when you load all the receiver settings.

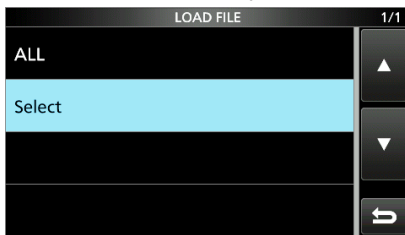

4. Touch the desired loading items.

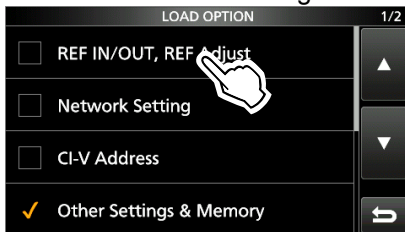

- "✓" is displayed left side of the selected option.
- ① The Set mode settings and Memory channel contents are always loaded.

5. Touch "<<Load>>."



- The load confirmation dialogue appears.
6. Touch [YES].
 - Starts file loading.
 - ① When you select "REF IN/OUT, REF Adjust" in step 4, "The new "REF IN/OUT, REF Adjust" setting will be saved" is displayed.
 7. After the loading has been completed, "Restart the IC-R8600" is displayed.
 - ① Turn OFF the receiver power, then turn ON again.

Deleting a data file

NOTE: Deleted data from a card cannot be recalled. Before deleting any data, back up the card data onto your PC.

1. Open the SAVE SETTING screen.
MENU » **SET > SD Card > Save Setting**
2. Touch the file desired to delete for 1 second.

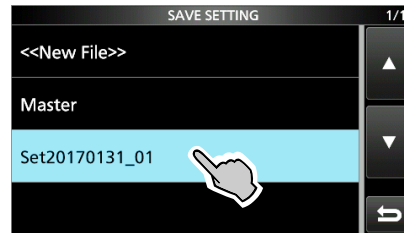

3. Touch "Delete."
① To delete all files, touch "Delete All."
① To cancel deleting, push **EXIT**.

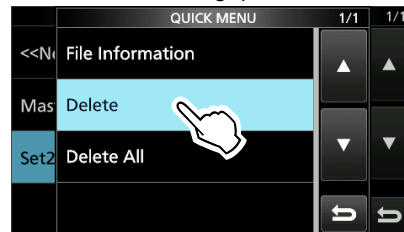

- The delete confirmation dialogue appears.

4. Touch [YES].
 - Deletes the selected file.
 - ① After deleting, returns to the SAVE SETTING screen.
5. To close the SD CARD screen, push **EXIT** several times.

Checking SD card information

1. Open the SD CARD screen.
MENU » **SET > SD Card**
2. Touch to select "SD Card Info."

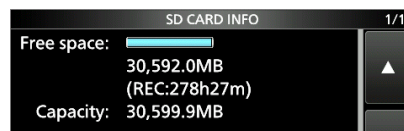
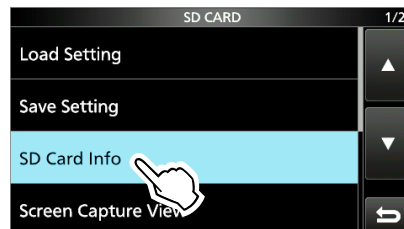

- Opens the SD CARD INFO screen.
3. To close the SD CARD screen, push **EXIT** several times.

Memory channels

GROUPS	MEMORY CHANNELS	USAGE
Group 00 ~ 99 (100 groups)	00 ~ 99	Has 100 memory groups. ① Up to 2000 channels can be separately stored in the 100 memory channel groups.
Auto Memory Write channels	A000 ~ A199 (200 channels)	Automatically stores frequencies into each 200 channels when a signal is received during an Auto Memory Write scan.
Scan Skip channels	S00 ~ S99 (100 channels)	100 scan skip channels can be stored into the memory channels. These scan skip channels are used for the Programmable scan, Fine Programmable scan, Auto Write Memory scan, ΔF scan, Fine ΔF scan and Programmable Skip scan.
Program Scan Edges	P00A/P00B ~ P49A/P49B (50 pairs)	50 pair of scan edges for the lower and upper frequency edges can be programmed. ① The same pair of frequencies are written as the default. ② You cannot clear nor leave them blank.

[Memory channel tree view]

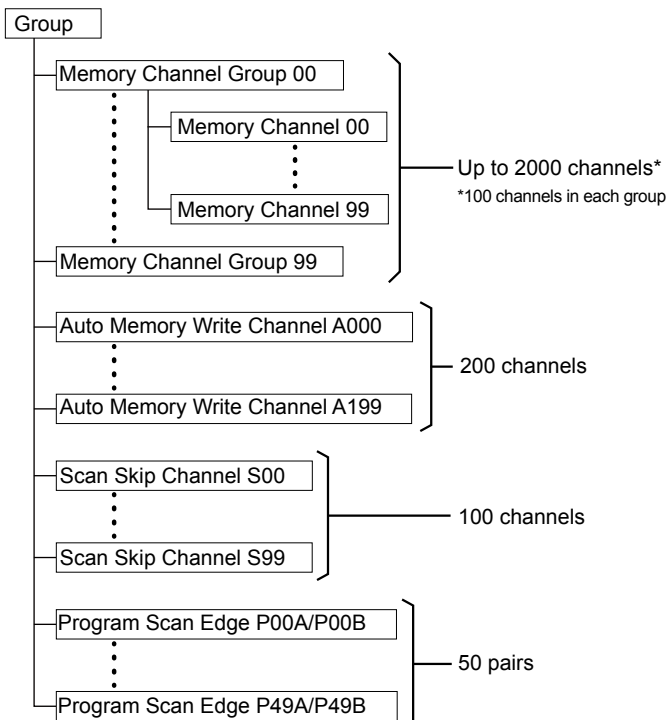

Selecting channel group

◇ Selecting with **▲GRP** / **▼GRP**

1. Push **V/M** to select the Memory mode.
2. Push **▲GRP** or **▼GRP** to select the group.
 - ① You can select only groups that contain a channel.
 - ② In the VFO mode, you can select blank groups.

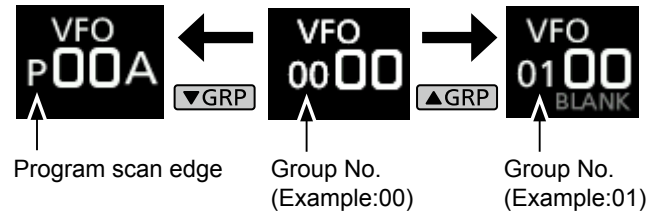

◇ Selecting on the **GROUP SELECT** screen

1. Touch the Memory channel number.



2. Touch [GROUP].



3. Rotate **(DIAL C)** and touch to select a memory group (00 ~ 99, A, S or P).

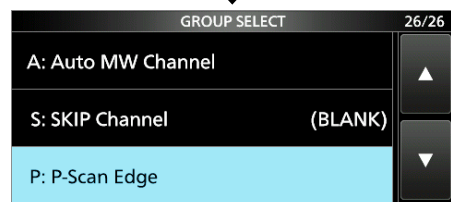

4. Push **EXIT** to close the VFO/MEMORY screen.

Selecting a memory channel

- Rotate **[DIAL C]** or **[MAIN DIAL]** to select the desired memory channel.

① Only the Memory channels that have contents are displayed.



◇ Selecting with **[DIAL C]**

1. Push **[V/M]** to select the Memory mode.
2. Rotate **[DIAL C]** to select the desired memory channel.

◇ Selecting with **[MAIN DIAL]**

1. Push **[V/M]** to select the Memory mode.
2. Push **[M-CH DIAL]**.
 - LED on the **[M-CH DIAL]** key lights.
3. Rotate **[MAIN DIAL]** to select a memory channel.

◇ Selecting using the keypad

1. Touch the memory channel number.

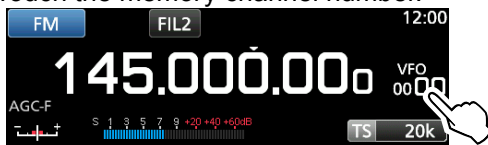

• The VFO/MEMORY screen is displayed.

2. Push **[▲GRP]** or **[▼GRP]** to select the group.
3. Touch **[CH-INP]**.



4. Touch the numeric keys to enter the desired memory channel number.
5. Touch **[ENT]** to set the entered memory channel.
6. Push **[EXIT]** to close the VFO/MEMORY screen.

Writing a memory channel

A single memory channel stores the frequency, receive mode and IF filter width besides the following items.

- Tuning step
- P.AMP ON/OFF
- ATT setting
- Antenna setting
- IP+ ON/OFF
- DUP mode
- DUP direction
- TSQ/L/DTCS setting
- DIGITAL Squelch settings
- Memory name
- SKIP Setting
- SELECT Setting

1. Set the frequency and receive mode and so on.
2. Push **[MW]**.
3. Touch to select the desired memory write option.

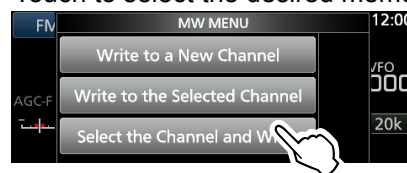

Memory write options

[Write to a New Channel]:

• The contents such as frequency and operating mode are written to a blank channel in the selected group.

[Write to the Selected Channel]:

• The selected channel is overwritten.

[Select the Channel and Write]:

• The channel is written to the channel selected on the CH SELECT screen.

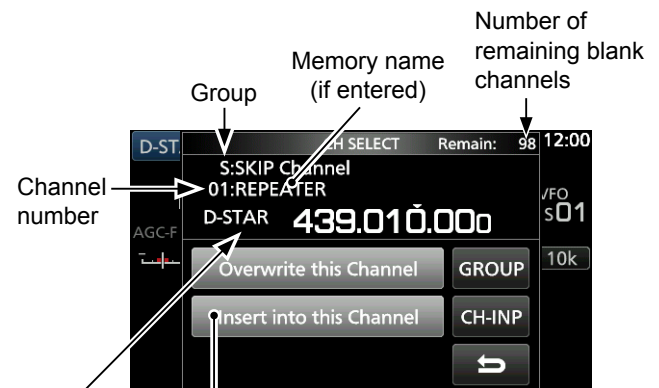

CH SELECT screen example

Insert a new channel without overwriting the selected channel.

① **Information:** Selecting a memory channel in a different group

You can select the desired Memory channel stored in all memory channel groups.

1. Push **[QUICK]**, and touch **[Channel Select Group Range]**.
2. Touch **[All Groups]**.
3. Rotate **[DIAL C]** to continuously select a memory channel in all memory channel groups.

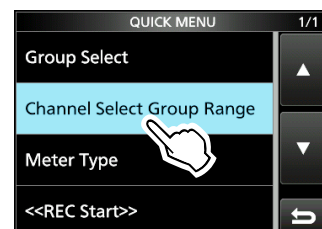

Copying the Memory contents

You can copy the Memory contents to the VFO.

1. Push **[V/M]** to select the Memory mode.
2. Select the memory channel to be copied.
3. Hold down **[V/M]** for 1 second.
 - Beeps sound and the selected memory contents are copied to the VFO.



4. Push **[V/M]** to select the VFO mode to confirm that the memory contents were successfully copied.

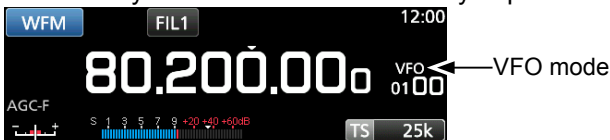

Inserting a blank channel

You can insert a blank channel between 2 Memory channels.

① This function is convenient to organize your memory channels.

1. Touch the Memory channel number.
 - The VFO/MEMORY screen opens.

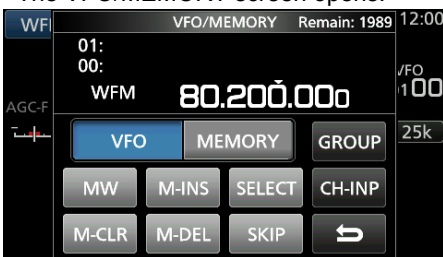

2. Select the channel to insert a blank channel below.
3. Touch **[M-INS]** for 1 second.
 - Beeps sound and a blank channel is inserted below



the selected memory channel.

4. Push **[EXIT]** to close the VFO/MEMORY screen.

Clearing a memory channel

When you clear a memory channel, you can choose whether to leave the cleared channel blank as a place holder, or keeping the deleted channel number.

① You cannot clear program scan edge channels.

1. Touch the Memory channel number.



• The VFO/MEMORY screen is displayed.

2. Rotate **(DIAL C)** to select the channel you want to clear.
3. **When clearing the memory channel contents:**
 - Touch **[M-CLR]** (Memory Clear) for 1 second.
 - Beeps sound and the selected memory contents are cleared but the memory channel remains as a blank channel.



When deleting the channel:

- Touch **[M-DEL]** (Memory Delete) for 1 second.
- Beeps sound and the memory channel is completely deleted.



4. Push **[EXIT]** to close the VFO/MEMORY screen.

Entering a group/memory name

You can assign a name of up to 16 characters to each channel group (00 ~ 99) and memory channel.

- You cannot change the group name of Auto MW, Skip and scan channels (Groups "A," "S" and "P").

◇ Entering a group name

1. Touch the Memory channel number.



- The VFO/MEMORY screen opens.

2. Touch [GROUP].



3. Select the channel group to enter a name.
4. While the channel group is selected, touch [QUICK].
5. Touch "Edit Name."

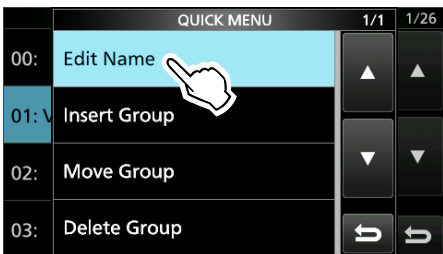

- The "GROUP NAME" editing screen is displayed.

6. Enter a name of up to 10 characters.



- ①See "Keyboard entering and editing" (p. 1-8) for details.

7. Touch [ENT] to save the entered name.
 - The MEMORY NAME screen closes and returns to the GROUP SELECT screen.



◇ Entering a memory name

1. Open the MEMORY screen.



2. Push [▲GRP] or [▼GRP] to select the group.
3. Rotate [DIAL C] to select the channel to enter a name.

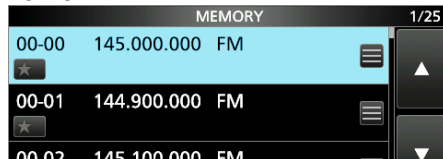

4. Touch [QUICK].
5. Touch "Edit Name."

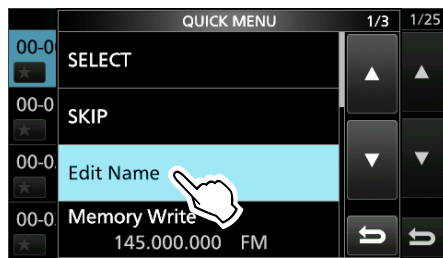

- The "MEMORY NAME" editing screen is displayed.

6. Enter a name of up to 10 characters.
 - ①See "Keyboard entering and editing" (p. 1-7) for details.



7. Touch [ENT] to save the entered name.
 - The MEMORY NAME screen closes and returns to the MEMORY screen.

About the MEMORY screen

You can edit the Memory channel contents on this screen.

- Open the MEMORY screen.

MENU » **MEMORY**

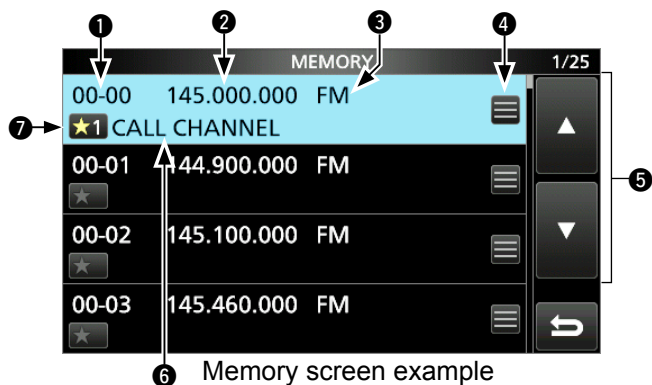

6 Memory screen example

1 Memory channel group and channel number

Displays the Memory group (00 ~ 99, A, S and P), and Memory channel number (00 ~ 99, A000 ~ A199, S00 ~ S99 and P00A/P00B ~ P49A/P49B) in each group.

2 Frequency

Displays the entered frequency.

3 Receive mode

Displays the selected receive mode.

4 Memory menu

Touch to display the MEMORY MENU.

- ① "SKIP," "Edit Name," "Memory Write" or "Memory Clear" is selectable.

5 [▲]/[▼] key

Touch to scroll the memory channel list.

- ① To select a memory channel in a different group, refer to page 8-2.

6 Memory name

Displays the memory name, if entered.

- ① To assign a memory name, refer to page 8-4.

7 Select memory icon

Touch this icon to set the Select number "★1" ~ "★9" or OFF.

- ① To clear the Select memory setting, touch this icon for 1 second, then select a clearing option.

① **Information:** You can also edit the memory channel in the QUICK MENU.

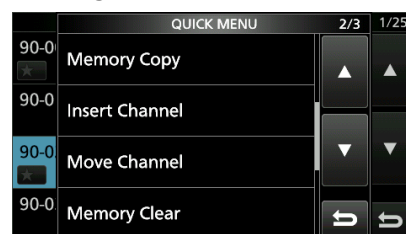

Example: Moving or copying a memory channel

1. Push **QUICK** to open the QUICK MENU.
2. Select the channel you want to move or make a copy of.
3. Open the QUICK MENU on the MEMORY screen.
4. Touch [Move Channel] or [Memory Copy].
5. Rotate **DIAL C** to select the destination channel.
6. Push **DIAL C**.
7. Push **EXIT** to close the QUICK MENU.

Scan types

SCAN TYPE	SCANNING DETAILS
VFO SCAN	
PROGRAMMED SCAN	Repeatedly scans between 2 Scan Edge frequencies of Program Scan Edge memory channels. The scan starts from the lower edge frequency. (p.9-4)
FINE PROGRAMMED SCAN	During a Programed scan, the scan speed decreases when the squelch opens, but the receiver keeps scanning. The scan tuning step changes to 10 Hz when the squelch opens.
Δ F SCAN	Repeatedly scans within the Δ F span area. The scan starts from the center frequency, then upper edge and lower edge. (p.9-5)
FINE Δ F SCAN	During a Δ F scan, the scan speed decreases when the squelch opens, but the receiver keeps scanning. The scan tuning step changes to 10 Hz when the squelch opens.
AUTO MEMORY WRITE SCAN	During a Programed scan, and when a signal is received, the frequency is automatically stored into an Auto Memory Write channel group. (p.9-6)
MEMORY SCAN	
MEMORY SCAN	Repeatedly scans memory channels, including Skip and Auto Write memory channels. You can select the group and the scan edge channel. (p.9-7)
SELECT MEMORY SCAN	Repeatedly scans all or one of 9 Select Memory channels. (p.9-7)
MODE SELECT MEMORY SCAN	Repeatedly scans the memory channels with the selected receive mode (ignoring other receive modes). (p.9-9)
PRIORITY SCAN	Periodically monitors a selected memory channel while receiving a signal on VFO. (p.9-2)

Basic scanning

Push **[SCAN]** to start or stop a scan, then touch the desired scan type.

① See the following pages for the Scan setting details. (p. 9-3)

◇ VFO scan and Memory scan

- Push **[SCAN]**.
 - If you started a scan of the same scan type before, hold down **[SCAN]** for a second, to start the same scan.
- Touch the desired scan type.

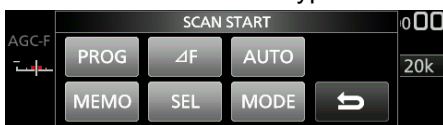

SCAN START screen

- The SCAN screen opens, and the scan starts.
- ① Rotating **(MAIN DIAL)** changes the scan direction: Rotate right for the up scan, rotate left for the down scan.
- ① To cancel the scan, push **[SCAN]**.
- ① You can hide the SCAN screen during a scan. Set [Display SCAN Screen (at SCAN START)] item to "OFF" on the SCAN SETTING screen. (p. 9-3)

◇ Priority scan

Follow the procedure below to start or stop a Priority scan..

① See page 9-2 for setting priority channel.

- Push **[PRIO]**.
 - "PRIO" is displayed.
 - ① Hold down **[PRIO]** for 1 second to monitor the priority channel.
- Push **[PRIO]** again to cancel the scan.

Adjusting the scan speed

Adjust the scan speed for slower or faster scans.

- Push **(DIAL A)**.
 - The setting menu opens.



- Touch **[SCAN SPEED]**.
- Rotate **(DIAL A)**.
 - Setting range: 1 (slow) ~ 30 (fast)
 - ① You cannot change the scan speed during a Fine Program scan or Fine Δ F scan.

Setting the Scan Resume function

◇ Setting the scan pause timer

You can set the delay time for when the scan resumes.

- Rotate **(DIAL A)** to set the pause time.
- ① The settable values are displayed while rotating the dial.



- 1s ~ 30s: The scan pauses for the set pause time, then resumes. (Even while still receiving a signal.)
- HOLD: The scan pauses until the signal disappears, then resumes after the preset delay time has expired.

◇ Setting the resume delay timer

You can set the delay time for when the scan resumes after the signal disappears.

1. Push **(DIAL A)**.
2. Touch "RESUME TIME."

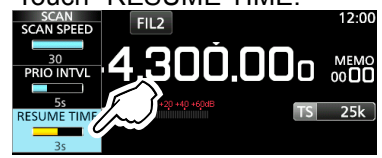

3. Rotate **(DIAL A)** to set the delay time.
 - 0s ~ 5s: The scan resumes after the preset delay time.
 - HOLD: The scan remains paused according to the Pause Timer, even if the signal disappears.
 - Rotate **(MAIN DIAL)** to resume the scan.
 - When PAUSE TIME is set to between 1 and 30 seconds, the scan resumes according to the PAUSE TIME setting.

◇ Setting the Scan Resume condition

You can set the Scan Resume options for when a signal is received.

1. Hold down **(DIAL A)** for 1 second.



2. Touch a resume option.
 - [OFF]: When a signal is received, the scan is canceled.
 - [ON]: When a signal is received, the scan pauses for the preset pause time, then resumes. (Set the pause time in PAUSE TIME and RESUME TIME.)

Setting the priority interval

Priority scan checks the priority channel according to the set interval.

1. Push **(DIAL A)**.
2. Touch [PRIO INTVL].



3. Rotate **(DIAL A)**.
 - Setting range: 1 ~ 15 seconds

Priority scan

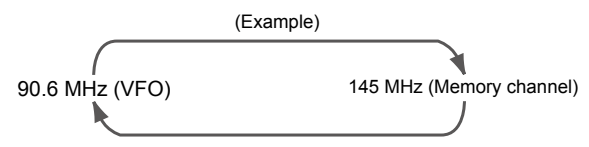

A priority scan periodically checks a selected memory channel* while receiving on a VFO frequency.

*Memory channel, Auto Memory Write channel, Scan Skip Channel or Program Scan Edge Channel.

◇ Priority scan operation

1. Open the SCAN screen.

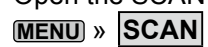

2. Touch [TYPE/SET].

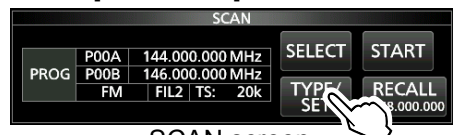

3. Touch [PRIO].



4. Touch [SELECT] to select the item to change.
 - No.: Priority memory preset number (0 ~ 9)
(You can save up to 10 pairs of Group and Ch.)
 - Group: Memory Group number
 - Ch: Memory channel number.

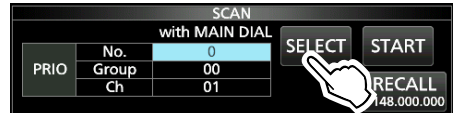

5. Rotate **(MAIN DIAL)** to change the setting.
 - ① You cannot select blank channels.
6. Touch [SELECT] several times to exit the edit mode, then touch [START] or push **(PRIO)**.
 - A Priority scan starts.

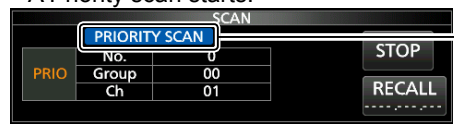

- To cancel the scan, push **(PRIO)** or touch [STOP].
7. To close the SCAN screen, push **(EXIT)**.

◇ Monitoring the Priority channel

- During a Priority scan, hold down **(PRIO)** for 1 second to monitor the priority channel.
 - "PRIO" is displayed while monitoring.
 - Push **(PRIO)** to cancel the monitoring.

Scan Setting screen

Configure the Scan on the Scan Setting screen.

1. Open the SCAN screen.

MENU » **SCAN**

2. Touch [TYPE/SET].

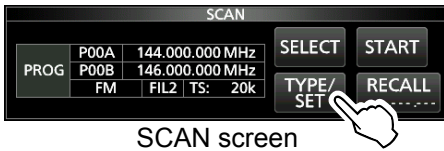

SCAN screen

3. Touch [SET].



4. Touch to select the desired item.

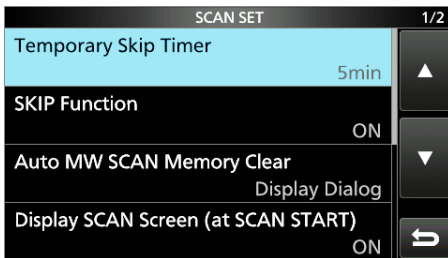

SCAN SET screen

5. Touch to select the desired option.

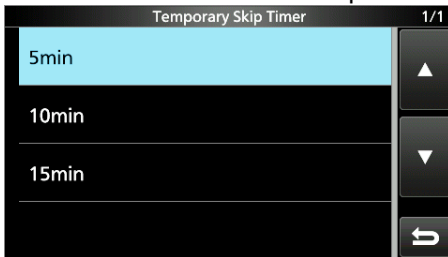

① See the right column for setting items and options.

6. To close the SCAN SET screen, push **EXIT**.

TIP: How to reset to the default setting

Touching the item or its option for 1 second displays the Quick menu, and then touch “Default” to reset to the default settings.

Temporary Skip Timer (Default: 5min)

Sets the period of time of the Temporary Skip timer. The Skip timer ignores the Temporary Skip signal for the set period of time.

- Options: 5, 10 and 15 minutes

SKIP function (Default: ON)

Sets the Skip (SKIP or PSKIP) function.

- OFF: Turns OFF the function. (You can use the Temporary Skip function (p. 9-10).)
- ON: The scan skips the memory channels that are programmed as skip channels.

Auto MW (Memory Write) SCAN Memory Clear (Default: Display Dialog)

Selects the option to start an Auto Memory Write Scan.

- OFF: Starts an MW scan without clearing Auto Write memory channels (A000 ~ A199).
- Display Dialog: Asks whether or not to clear Auto Write memory channels (A000 ~ A199) before starting an MW scan.
- ON: Automatically clears Auto Write memory channels (A000 ~ A199) before starting an MW scan.

Display SCAN Screen (at SCAN START) (Default: ON)

Selects whether or not to display the SCAN screen when you push **SCAN** to start a scan (except Priority scan).

- OFF: Does not display the SCAN screen.
- ON: Displays the SCAN screen.

MAIN DIAL Operation (SCAN) (Default: Up/Down)

Selects the scan operation when you rotate **MAIN DIAL** during a scan.

- OFF: Cancels the scan.
- ON: Changes the scan direction. Rotate right for an up scan, rotate left for a down scan.

Programmed scan and Fine Programmed scan

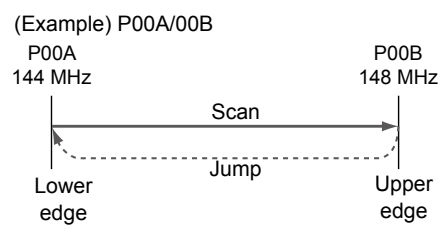

Programmed scan and Fine Programmed scan



Repeatedly scans between two Scan Edge frequencies (P00A/P00B ~ P49A/P49B).

- ① To change the Scan Edge Memory channels, see "Writing a memory channel" for details. (p. 8-2)
- ① If the both Scan Edges are the same frequencies, the Programmed scan does not start.
- ① In the Fine Programmed scan, the scan speed decreases when the squelch opens, but the receiver keeps scanning. The scan tuning step changes to 10 Hz when the squelch opens.

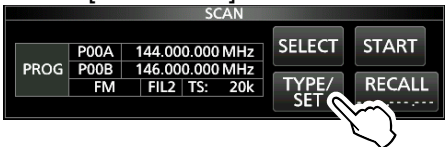
◇ Programmed scan operation

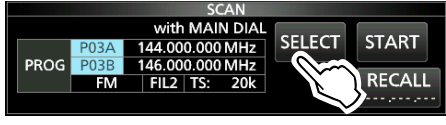
1. Open the SCAN screen.
 MENU » SCAN
2. Touch [TYPE/SET].

3. Touch [PROG].

4. Touch [SELECT] to select the item* to change, *Scan edge channel number (Example: P00A/P00B), scan edges (lower and upper frequencies), receive mode, filter and tuning step (TS).

5. Rotate (MAIN DIAL), or to touch [EDIT] to change the setting.
 ① The changed settings are stored in the Program Scan Edge channel.
6. Touch [SELECT] several times to exit the edit mode, then touch [START] or hold down [SCAN] for 1 second.
 • The Programmed scan starts.

PROGRAM SCAN
 P00A 144.000.000 MHz
 P00B 146.000.000 MHz
 FM FIL2 TS: 20k
 FINE STOP
 EDGE LOAD RECALL 144.440.000
 Jumps to the lower edge Recalls the VFO frequency before the scan starts

- ① Touch [STOP] or push [SCAN] to cancel the scan.
7. To close the SCAN screen, push [EXIT].

◇ Fine Programmed scan operation

1. Start a Programmed scan.
 ① See steps 1 ~ 6 in "Programmed scan operation" to the left for details.
2. While Programmed scanning, touch [FINE].
 ① Each touch toggles the Programmed scan and the Fine Programmed scan.

While Programmed scanning

FM FIL2 12:00
 144.580.000 VFO 0000
 AGC-F S 1 3 5 7 9 +20 +40 +60dB
 SCAN TS: 20k
 PROGRAM SCAN
 P03A 144.000.000 MHz
 P03B 146.000.000 MHz
 FM FIL2 TS: 20k
 FINE STOP
 EDGE LOAD RECALL 147.660.000
 Blinks



FM FIL2 12:00
 144.135.300 VFO 0000
 AGC-F S 1 3 5 7 9 +20 +40 +60dB
 SCAN TS: 20k
 FINE PROGRAM SCAN
 P03A 144.000.000 MHz
 P03B 146.000.000 MHz
 FM FIL2 TS: 20k
 FINE STOP
 EDGE LOAD RECALL 147.660.000
 Blinks

While Fine Programmed scanning

- ① To cancel the scan, touch [STOP] or push [SCAN].
3. To close the SCAN screen, push [EXIT].

ΔF scan

ΔF scan and Fine ΔF scan

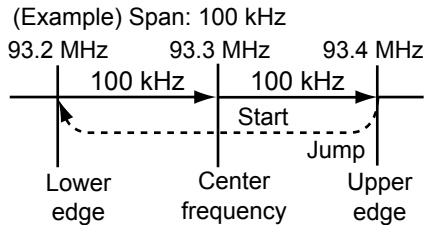

Repeatedly scans within the ΔF span area. The scan starts from the center frequency of VFO or selected memory channel.

① In fine ΔF scan, the scan speed decreases when the squelch opens, but the receiver keeps scanning. The scan tuning step changes to 10 Hz when the squelch opens.

◇ ΔF scan operation

1. Select the VFO or Memory mode, then set the center frequency of the scan.
2. Open the SCAN screen.

MENU » **SCAN**

3. Touch [TYPE/SET].

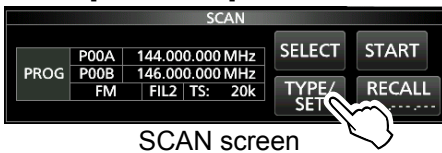

SCAN screen

4. Touch [ΔF].



5. Touch [SELECT] to select the item, then rotate **(MAIN DIAL)** to change the setting.
 - Set the center frequency and span.

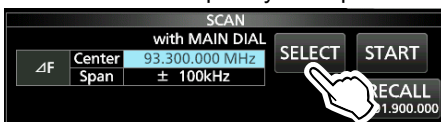

① The scan does not start when the tuning step is wider than the span.

6. Touch [SELECT] several times to exit the edit mode, then touch [START] or hold down **(SCAN)** for 1 second. to start the ΔF scan.

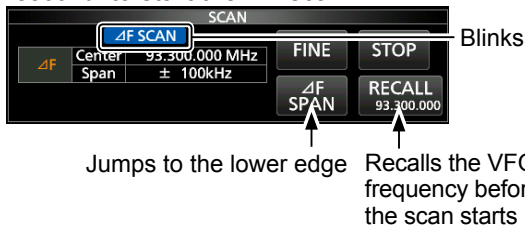

① To cancel the scan, touch [STOP] or push **(SCAN)**.

7. To close the SCAN screen, push **(EXIT)**.

◇ Fine ΔF scan operation

1. Start the ΔF scan.
 - ① See steps 1 ~ 6 in “ΔF scan operation” to the left for details.
2. While ΔF scanning, touch [FINE].
 - Each touch toggles the ΔF scan and the Fine ΔF scan.

While ΔF scanning

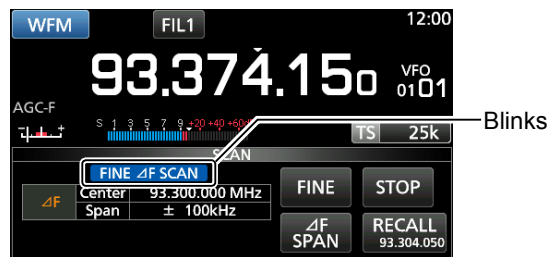

While Fine ΔF scanning

- ① To cancel the scan, touch [STOP] or push **(SCAN)**.
3. To close the SCAN screen, push **(EXIT)**.

Auto Memory Write scan

Auto Memory Write scan

The received signal frequency is stored into an Automatic Memory Write group

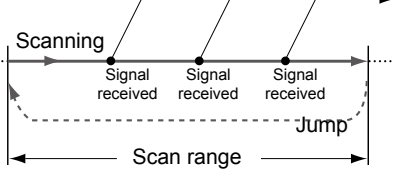

Channel	Frequency
A000	76.500
A001	80.200
A002	85.100
⋮	---
A199	---

When a signal is received during a Programmed scan, the frequency is automatically stored into an Auto Memory Write channel group (A000 ~ A199).

- ① When no blank channels is left in group A (A000 ~ A199), the Auto Memory Write scan automatically cancels. You can clear the all channels in group A (A000 ~ A199) every time you start a Auto Memory Write scan. See page 9-3 for details.
- ① The channels in group A (A000 ~ A199) are automatically aligned at the top, and all the blank channels are removed (A000 ~ A199).

◇ Auto Memory Write scan operation

1. Open the SCAN screen.

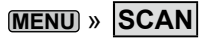

2. Touch [TYPE/SET].

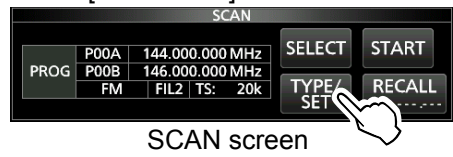

SCAN screen

3. Touch [AUTO].



4. Touch [SELECT] to select the item*, then rotate [MAIN DIAL] to change the settings.

*Program Scan Edge number (Example: P00A/P00B), scan edges (lower and upper frequencies), receive mode, filter and tuning step (TS).

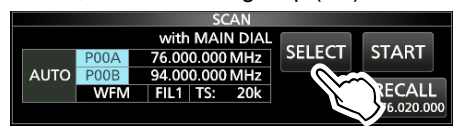

① The changed settings are stored in the Program Scan Edge channel.

5. Touch [SELECT] several times to exit the edit mode, then touch [START].



• The confirmation dialog is displayed.

6. Touch [YES].

• The Auto Memory Write scan starts.

① If you do not want to clear the memory channels in the group A (A000 ~ A199), touch [NO].

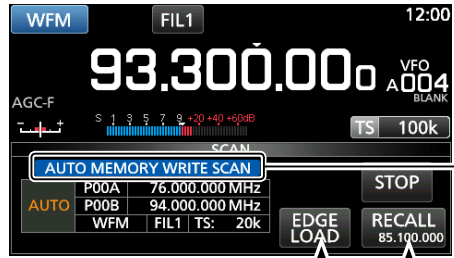

Jumps to the lower edge

Recalls the VFO frequency before the scan starts

Blinks

① To cancel the scan, touch [STOP] or push [SCAN].

7. To close the SCAN screen, push [EXIT].

Memory scan and Select Memory scan

Memory scan

(Example) Group: ALL (Each channel is in the different group.)

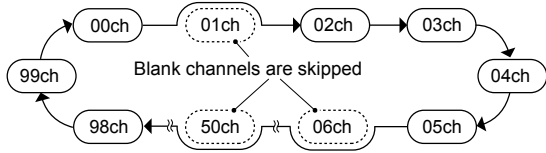

Repeatedly scans all entered Memory channels except Program Scan Edges.

- ① You can scan memory channels only in the desired group.
- ① Blank channels are skipped.
- ① If two or more Memory channels are not entered, the Memory scan does not start.

◇ Memory scan operation

1. Open the SCAN screen.

MENU » **SCAN**

2. Touch [TYPE/SET].

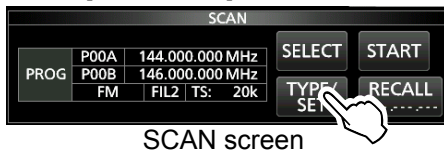

3. Touch [MEMO].

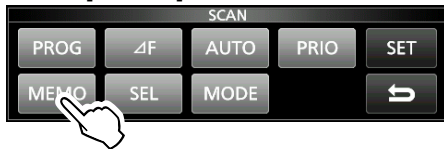

4. Touch [SELECT] to select the item, then rotate **MAIN DIAL** to change the setting.

- Set the channel group* and edge channels.
- *If you do not specify the group, set [Group] to "ALL."

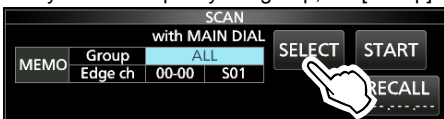

5. Touch [SELECT] several times to exit the edit mode, then touch [START].

- The Memory scan starts.

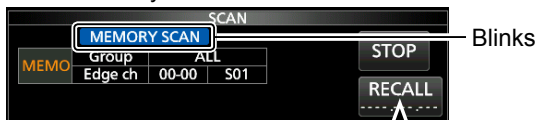

Deactivated during a Memory scan

6. To close the SCAN screen, push **EXIT**.

Select Memory scan

(Example) Group: ALL (Each channel is in the different group.)

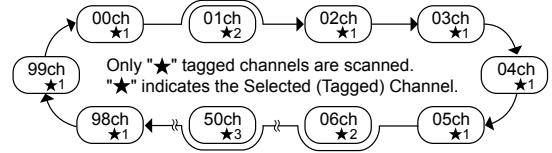

Repeatedly scans all or one of 9 Select Memory channels (★1 ~ ★9) that are assigned as Select Memory channels.

- ① You can scan Select Memory channels only in the desired group.
- ① If two or more Memory channels are not assigned as a Select Memory channels, the Select Memory scan does not start.

◇ Select Memory scan operation

1. Open the SCAN screen.

MENU » **SCAN**

2. Touch [TYPE/SET].

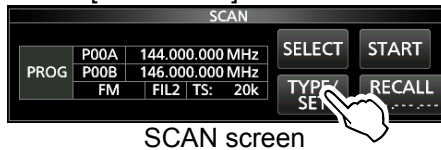

3. Touch [SEL].

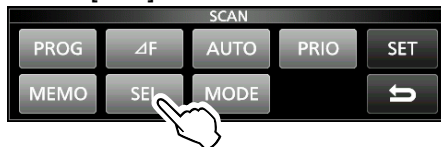

4. Touch [SELECT] to select the item, then rotate **MAIN DIAL** to change the setting.

- Set the channel group*, edge channels and the Select Scan number (Sel No.).

*If you do not specify the group, set [Group] to "ALL."

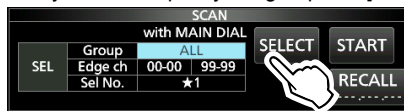

5. Touch [SELECT] several times to exit the edit mode, then touch [START] to start the Select Memory scan.

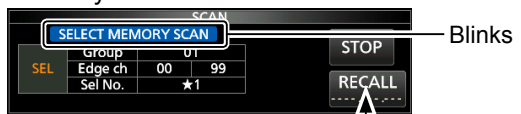

Deactivated during a Memory scan

6. To close the SCAN screen, push **EXIT**.

Memory scan and Select Memory scan (Continued)

◇ **Setting Select Memory channels**

Repeatedly scans only Memory channels that are assigned as Select Memory channels (★1 ~ ★9).

① You cannot assign the Programed Scan Edge channels (P00A/P49A ~ P00B/P49B) as Select Memory channels.

1. Touch the memory channel number.

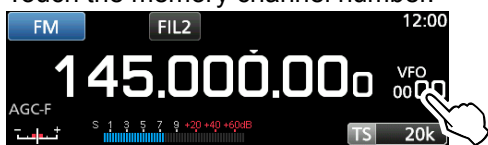

2. Touch [GROUP].

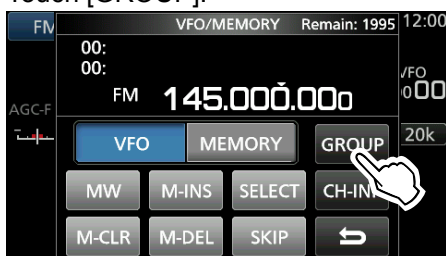

VFO/MEMORY screen

3. Rotate (DIAL C), then touch to select the group.



4. Rotate (DIAL C) to select the Memory channel you want to assign as a Select Memory channel.

5. Touch [SELECT] to set the Select scan number.

① Each touch changes between “★1” to “★9,” and “(no icon).”



VFO/MEMORY screen

Displayed

6. To close the VFO/MEMORY screen, push [EXIT].

◇ **Canceling the Select Memory channel settings**

You can cancel the select memory setting, by removing the Select Memory channel assignment (★1 ~ ★9).

1. Touch the memory channel number.

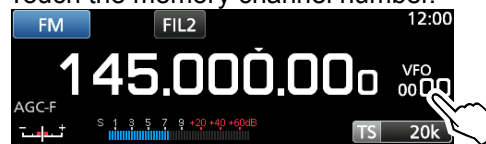

2. Touch [SELECT] for 1 second.



3. Touch the desired option to cancel the Select setting.

① Touch [All] to cancel all Select settings (★1 ~ ★9) at a time.

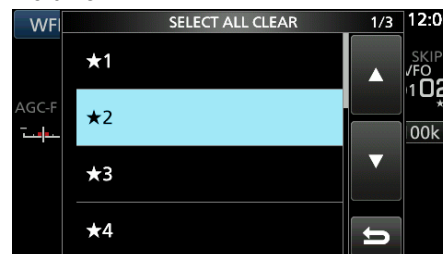

4. Touch [YES] to cancel the Select setting.

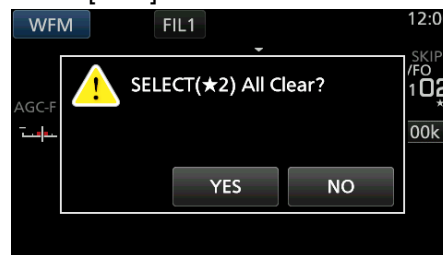

① The selected Select setting is canceled and returns to the previous display.

Mode select memory scan

(Example) Group: ALL (Each channel is in the different group.)

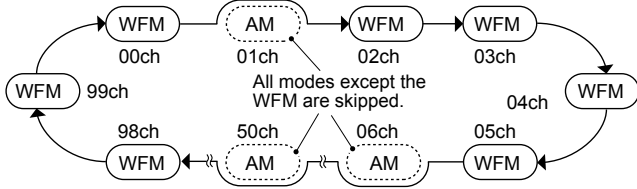

Repeatedly scans the selected receive mode (ignoring other modes) while memory scanning, except Programed Scan Edge channels (P00A/P49A ~ P00B/P49B).

◇ Setting the receive mode

1. Select the receive mode.
2. Open the SCAN screen.

MENU » **SCAN**

3. Touch [TYPE/SET].

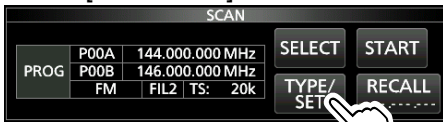

SCAN screen

4. Touch [MODE].



5. Touch [SELECT] to select the item, then rotate **MAIN DIAL** to change the setting.

- Set the channel group and edge channels.
- ① You cannot change the receive mode on this screen.



6. Touch [SELECT] several times to exit the edit mode, then touch [START].

- The mode select memory scan starts.
- ① "MODE SELECT MEMORY SCAN" and decimal points blink while scanning.

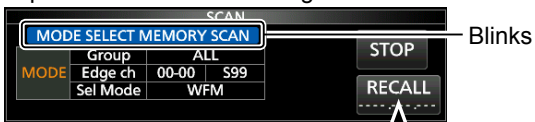

Blinks
Deactivated during a Memory scan

- Touch [STOP] to cancel the scan.
7. To close the SCAN screen, push **EXIT**.

Setting the skip frequency

You can set a frequency as a skip frequency that is skipped (ignored) during a VFO scan*.

*Programmed scan, Fine Programmed scan, Auto Write Memory scan, ΔF scan and Fine ΔF scan

◇ Setting the skip frequency

- Hold down **MW** for 1 second while a signal is received and the scan is paused.
 - The frequency is stored as the Scan Skip channel (S00 ~ S99).
 - ① The "PSKIP (Program SKIP)" is displayed on the skip channel.
 - ① During a VFO scan, the skip frequency is not skipped.

◇ Canceling the skip frequency

1. Touch the memory channel number.



2. Touch [SKIP].

- ① Each touch changes between "SKIP," "PSKIP" and "(no icon)."



VFO/MEMORY screen

- ① "PSKIP" disappears and the skip setting is cancelled.
3. To close the VFO/MEMORY screen, push **EXIT**.

Setting the Temporary Skip

You can set a frequency as a temporary skip frequency that is skipped (ignored) during a VFO scan* or memory scan, for a period of time (default: 5 minutes).

*Programmed scan, Fine Programmed scan, Auto Write Memory scan, ΔF scan and Fine ΔF scan.

1. Start a VFO or memory scan.
MENU » **MEMORY**
2. Push **QUICK**.
 • The QUICK MENU is displayed.
3. While the scan is paused and if you want to skip the received signal, touch [Temporary Skip].
 ① If you touch during scan, a beep sounds and the QUICK MENU closes.

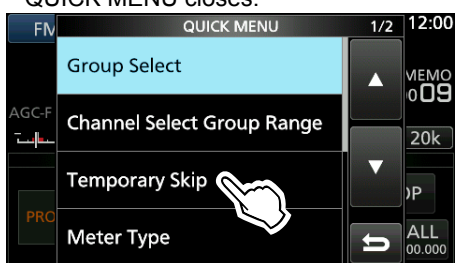

QUICK MENU

- The Temporary Skip is set, then the scan resumes.



TIP: About the Temporary Skip

- You can set up to 5 skip frequencies. When you set the 6th frequency, the oldest frequency will be deleted.

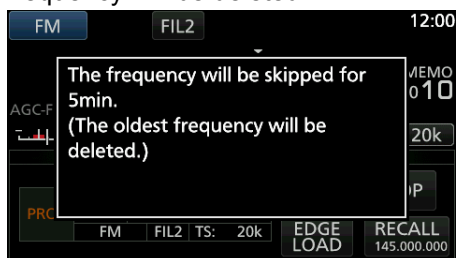

- The Temporary Skip is canceled when:
 - The time that is set to the Temporary Skip Timer item (p. 9-3) has passed.
 - You turn OFF the receiver power.
 - You cancel the scan.

Skip channel for memory scan

You can set a selected memory channel as a Skip channel (SKIP or PSKIP) which is skipped during a memory scan.

① You cannot assign the Programmed Scan Edge channels (P00A/P49A ~ P00B/P49B) as skip channels.

1. Open the MEMORY screen.
MENU » **MEMORY**
2. Rotate **DIAL C** and touch to select the memory channel you want to set or clear the skip setting.
 ① Push **▲GRP** or **▼GRP** to change the group.



MEMORY screen

3. Push **QUICK**.

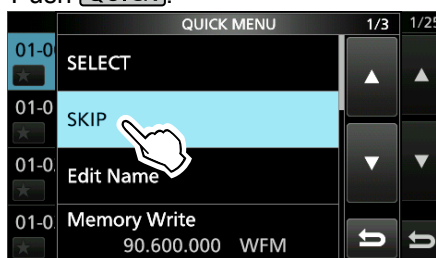

4. Touch [SKIP].
 • The SKIP screen is displayed.
5. Touch the desired option.
 - OFF: Clears the skip setting.
 - SKIP: Skipped during a memory scan. (Not skipped during a VFO scan.)
 - PSKIP: Skipped during a VFO or memory scan.

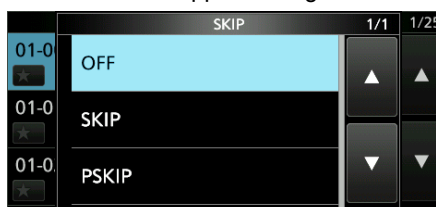

- "SKIP" is displayed.

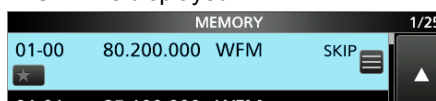

6. To close the MEMORY screen, push **EXIT**.

Voice Squelch Control function

FM, WFM, AM and SSB modes

The Voice Squelch Control (VSC) function opens the squelch, or stops the scan only when voice components are detected in the signal.

① It is convenient to receive only voice communications.

1. Push **[DIAL C]**.
2. Touch **[VSC]**.
 - Each touch turns the VSC function ON or OFF.
 - "VSC" appears when the function is ON.

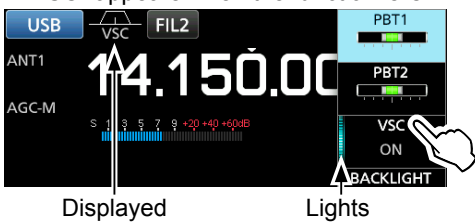

Displayed

Lights

3. To close the setting menu, push **[EXIT]**.

NOTE:

The VSC function is designed to not detect a continuous audio signal. When receiving a signal such as a radio broadcast program that contains a continuous audio, the received audio may be broken up. In such case, turn OFF the VSC function.

Tone scan operation

FM mode

The IC-R8600 can detect subaudible tone frequency or the DTCS code in a received signal. You can determine the tone frequency or DTCS code necessary to open the squelch.

1. On the FUNCTION screen, touch **[TONE]** for 1 second.
2. Touch **[T-SQL TONE]** or **[DTCS CODE]**.
(Example: T-SQL TONE)

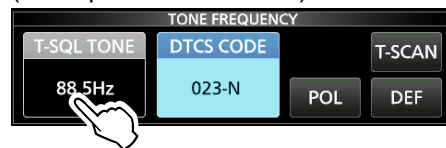

3. Touch **[T-SCAN]**.

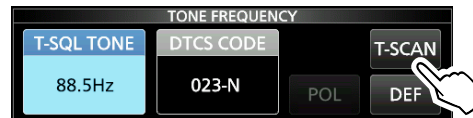

- The Tone scan starts.

① Information

- The selected tone frequencies or codes are scanned, and "SCAN" blinks under the frequency readout.
 - The audio is muted.
 - The scan speed is slow when the squelch is open, and is fast when the squelch is closed.
4. When the tone frequency or code is detected, the tone scan pauses.

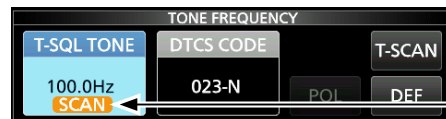

Blinks during scan

- The detected frequency or code is automatically set.
5. To cancel the scan, touch **[T-SCAN]** again.
① The last scanned tone frequency or code is displayed.
 6. To close the TONE FREQUENCY screen, push **[EXIT]**.

Setting the Time and Date

Manually set date and time without accessing the time management server.

◇ Setting date

1. Open the Date screen.
MENU » **SET > Time Set > Date/Time > Date**
2. Touch [+] or [-] to set the date.
3. Touch [SET] to store the entry.

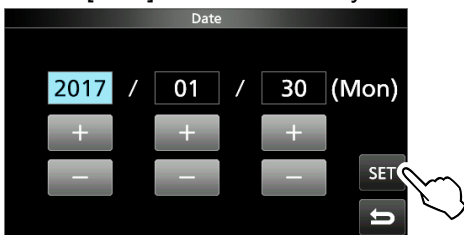

4. To close the Date screen, push **EXIT** several times.

◇ Setting time

1. Open the Time screen.
MENU » **SET > Time Set > Date/Time > Time**
2. Touch [+] or [-] to set the current time.
3. Touch [SET] to store the entry.

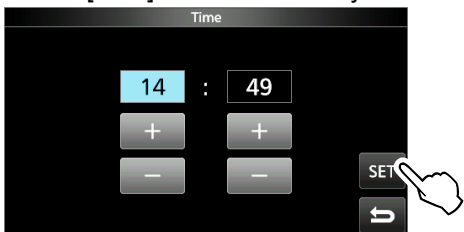

4. To close the Time screen, push **EXIT** several times.

NOTE: The backup battery for the internal clock

The IC-R8600 has a rechargeable Lithium battery to backup the internal clock. If you connect the receiver to a power source, the battery is charged and it keeps the correct clock setting. However, if you do not connect the receiver to a power source for a long period of time, the battery will discharge. In that case, the receiver resets the internal clock.

If you do not use the receiver for a long period, we recommend that you connect the receiver to a power source at least once a month. The charging period is two days whether the receiver's power is ON or OFF.

NTP Time Server

The NTP function periodically synchronizes the internal clock with the time management server.

① To use this function, an internet connection are necessary.

◇ Execute the time synchronization

The IC-R8600 accesses the NTP server address that is set in the "NTP Server Address" item.

1. Open the DATE/TIME screen.
MENU » **SET > Time Set > Date/Time**
2. Touch <<NTP TIME SYNC>>.

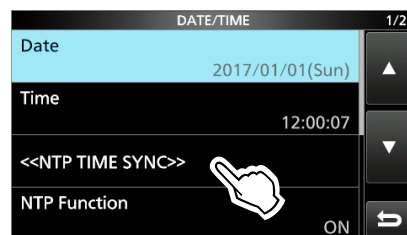

- The "Connecting to the NTP server" dialog is displayed.

3. When the "Succeed" dialog is displayed, touch [OK].
4. To close the DATE/TIME screen, push **EXIT** several times.

◇ Setting the NTP Server address

1. Open the DATE/TIME screen.
MENU » **SET > Time Set > Date/Time**
2. Touch [NTP Server Address].
3. Enter the address using the keypad, then touch [ENT].
4. To close the DATE/TIME screen, push **EXIT** several times.

Timer

◇ Setting the Sleep timer

The Sleep timer automatically turns OFF the receiver power after the set period of time ends.

- Settable range: 5 ~ 120 minutes (in 5 minutes steps)

1. Hold down **TIMER** for 1 second.
2. Touch [Sleep Timer].



3. Rotate **DIAL C** to set the desired length of time.



4. Touch [SET].
 - The timer LED **TIMER** lights orange.
 - 10 seconds before the sleep timer period ends, the receiver starts sounding beeps and the timer LED blinking, then turns OFF.
 - ① When the sleep timer ends, the time period set in step 3 is cleared.
 - ① Each push of **TIMER** stops and resumes the timer.
5. To close the TIMER screen, push **EXIT** several times.

NOTE: About the Timer accuracy

Since the Sleep timer counts in 'minute' steps (not counts in 'second' steps), it may have maximum 59 seconds of error.

◇ Setting the Daily timer

The IC-R8600 automatically turns power ON or OFF on the specified day and time.

- ① You can set up to 3 timer slots for different timer setting.

1. Hold down **TIMER** for 1 second.
2. Touch to select a timer slot.

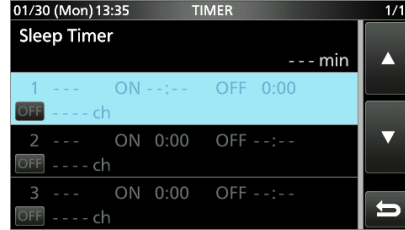

TIMER screen

3. Rotate **DIAL C** to set each item for the timer slot. (Example: TIMER1).
 - ① See page 10-3 for each item's details.
 - ① Push **QUICK** to reset to the default setting or cancel.

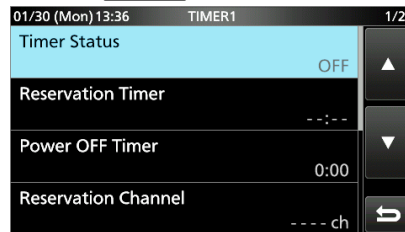

4. After you configure the Timer, touch [**<<Set>>**].

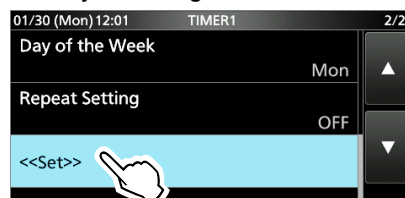

5. Touch [YES].
 - The "Set Timer?" dialog appears.
 - The timer LED **TIMER** lights orange.
 - ① **When the Power OFF Timer is set:** 10 seconds before the sleep timer period ends, the receiver starts sounding beeps and the timer LED blinking, then turns OFF.
 - ① Each push of **TIMER** stops and resumes the timer.

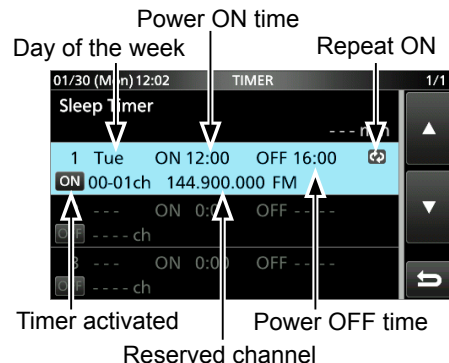

6. To close the TIMER screen, push **EXIT** several times.

Timer (continued)

◇ Timer setting items

Timer Status (Default: OFF)

Turns this timer slot ON or OFF. Set to ON to activate the Timer.

① **ON** is displayed in the slot while the Timer is activated.

Reservation Timer (Default: 00:00)

Sets the time to turn ON the power in the 24-hour clock.

① If you use the Timer to turn OFF the power, push **QUICK** then touch [Clear] to clear the Reservation Timer.

Power OFF Timer (Default: --:--)

Sets the time to turn OFF the power in the 24-hour clock.

① If you use the timer to turn ON the power, push **QUICK** then touch [Clear] to clear the Power OFF Timer.

NOTE:

If you set the Power OFF timer earlier than Reservation Timer, the receiver will not automatically turn OFF.

For example, if Reservation Timer is set to "8:00" and Power OFF timer is set to "7:30," the receiver will not automatically turn OFF.

Reservation Channel (Default: ----)

Selects the memory channel number that is displayed on start up. When Reservation Timer is set to ON, the IC-R8600 starts with the selected memory channel.

① You can select any memory channel except blank one.

① If you want to start with currently selected memory channel, push **QUICK** then touch [Clear].

① Even if the receiver power is ON, the currently selected memory channel is automatically changed to the selected memory channel.

Day of the Week (Default: ---)

Selects the day of the week to activate the Timer every week.

• If you want to activate the Timer everyday, push **QUICK** then touch [Clear].

Repeat Setting (Default: OFF)

Selects the timer repeat option.

• OFF: The timer activates only once.
(The Timer Status item is automatically reset to "OFF," after the Timer has been activated.)

• ON: The Timer activates everyday, or every week if a day of the week is selected.

① **ON** is displayed in the slot when "ON" is selected.

<<Set>>

Touch to store the timer settings and starts the Timer.

◇ About the Timer recording

You can start the recording using the Timer.

- Start the recording then turn OFF the power.
- When the IC-R8600 is turned on by the Timer, the recording is automatically starts, according to the preset recording setting (p. 6-4).

Set mode description

You can use the Set mode to set infrequently changed values or function settings.

TIP: The Set mode is constructed in a tree structure. You may go to the next tree level, or go back a level, depending on the selected item.

◇ Entering the Set mode

1. Push **[MENU]**.
 - Opens the MENU screen.
2. Touch **[SET]**.

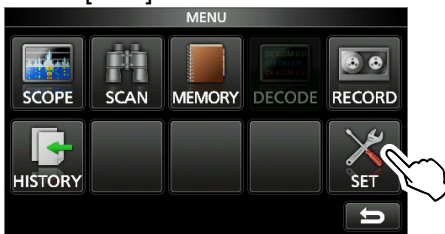

MENU screen

3. Rotate **[DIAL C]** to select the desired item.

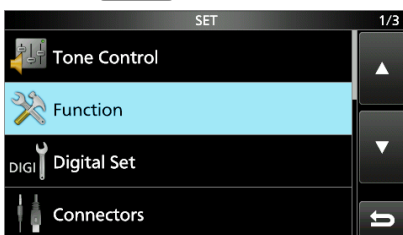

4. Push **[DIAL C]** to go to the next tree level.
 - ① You can also go to the next tree level by directly touching the desired item in the screen.
 - ① To go back the previous tree level, push **[EXIT]**.
5. Repeat steps 3 and 4 to open the desired item's setting screen.

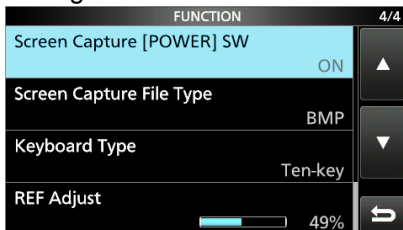

6. Rotate **[DIAL C]** to select the desired option, and then push **[DIAL C]** to set it.

① Information

- You can also select the option by directly touching the option or **[▲/+]** or **[▼/-]** on the screen.
- To continue setting other items in the same tree level, repeat step 6.
- To continue setting other items in a different tree level, push **[EXIT]** to go back the previous tree level.

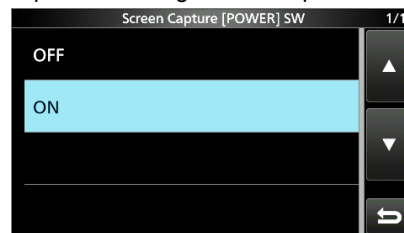

7. To close the SET screen, push **[EXIT]** several times.

TIP: How to reset to the default setting

Pushing **[QUICK]** opens the Quick menu, and then touch "Default" to reset to the default settings.

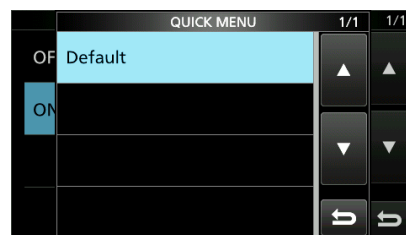

Tone Control

MENU » SET > Tone Control > **FM**

HPF/LPF (Default: - - - - -)

Sets the receive audio high-pass filter and low-pass filter cutoff frequencies in 100 Hz steps.

Selectable ranges:

- HPF: 100 ~ 2000 Hz
- LPF: 500 ~ 2400 Hz

Bass (Default: 0)

Treble (Default: 0)

Sets the bass or treble level of the receive audio.

- Range: -15 ~ +15

De-Emphasis(50k) (Default: OFF)

De-Emphasis(15k) (Default: ON)

De-Emphasis(7k) (Default: ON)

Turns the de-emphasis circuit ON or OFF for each bandwidth of filter (50k/15k/7k).

- OFF: The de-emphasis circuit is turned OFF.
- ON: The de-emphasis circuit is turned ON for the selected band width.

MENU » SET > Tone Control > **WFM**

Bass (Default: 0)

Treble (Default: 0)

Sets the bass or treble level of the receive audio.

- Range: -15 ~ +15

MENU » SET > Tone Control > **AM/SSB/CW/FSK/
D-STAR/P25/dPMR/NXDN/DCR**

HPF/LPF (Default: - - - - -)

Sets the receive audio high-pass filter and low-pass filter cutoff frequencies in 100 Hz steps.

Selectable ranges:

- HPF: 100 ~ 2000 Hz
- LPF: 500 ~ 2400 Hz

Bass (Default: 0)

Treble (Default: 0)

Sets the bass or treble level of the receive audio.

- Range: -15 ~ +15

Function

MENU » SET > **FUNCTION**

Beep Level (Default: 50%)

Sets the beep output level.

- Range: 0 ~ 100%

① If the "Beep (Confirmation)" item is set to "OFF," no beep sounds.

Beep Level Limit (Default: ON)

Selects whether or not to limit the volume up to the specified level.

- OFF: Does not limit the volume level.
- ON: Limits the volume level.

Further rotation of **(DIAL B)** does not increase the level.

Beep (Confirmation) (Default: ON)

Turns the Confirmation beep ON or OFF.

- OFF: Does not sound a beep.
- ON: Sounds the beep when a key is pushed.

① If the "Beep Level" item is set to "0%," no beep sounds.

SPEECH > SPEECH Language (Default: English)

Selects the speech language.

- English: Speech in English.
- Japanese: Speech in Japanese.

SPEECH > SPEECH Speed (Default: Fast)

Selects the speech speed.

- Slow: Speech speed is slow.
- Fast: Speech speed is fast.

SPEECH > S-Level SPEECH (Default: ON)

Turns the S-meter level announcement ON or OFF.

- OFF: When you push **(SPEECH LOCK)**, the frequency and receive mode is announced.
- ON: When you push **(SPEECH LOCK)**, the S-meter level, frequency and receive mode are announced.

SPEECH > MODE SPEECH (Default: OFF)

Turns the receive mode announcement ON or OFF.

- OFF: The receive mode is not announced.
- ON: The receive mode is announced when you change the receive mode.

SPEECH > SCAN SPEECH (at Receive Pause)
(Default: OFF)

Turns the frequency announcement ON or OFF.

- OFF: The frequency is not announced.
- ON: When a signal is received during a scan, the frequency and receive mode is announced.

① If the "S-Level SPEECH" item is set to "On," S-Meter level is also announced.

Function (Continued)

SPEECH > **SPEECH Output for Ext connectors** (Default: All)

Selects the announcement condition to output from the external terminals (USB, LAN, AF/IF and EXT-SP).

- OFF: The announcement is not output.
- Push/Touch: The announcement is output when you push **[SPEECH LOCK]**, or touch the screen.
- All: The announcement is output when you push **[SPEECH LOCK]** or touch the screen, or when a signal is received during a scan.

① The announcement is not output if [S-Level SPEECH], [MODE SPEECH] or [SCAN SPEECH] is set to "OFF."

SPEECH > **SPEECH Output for Recording** (Default: All)

Selects the announcement recorded condition.

- OFF: The announcement is not recorded.
- Push/Touch: The announcement is recorded when you push **[SPEECH LOCK]**, or touch the screen.
- All: The announcement is recorded when you push **[SPEECH LOCK]** or touch the screen, or when a signal is received during a scan.

① The announcement is not recorded if [S-Level SPEECH], [MODE SPEECH] or [SCAN SPEECH] is set to "OFF."

SPEECH > **SPEECH Level** (Default: 50%)

Sets the announcement output level.

- Range: 0 ~ 100%

[SPEECH/LOCK] Switch (Default: SPEECH/LOCK)

Selects the **[SPEECH LOCK]** key action.

- SPEECH/LOCK: Pushing **[SPEECH LOCK]** turns ON the Speech function.
Holding down **[SPEECH LOCK]** turns the Lock function ON or OFF.
- LOCK/SPEECH: Pushing **[SPEECH LOCK]** turns the Lock function ON or OFF.
Holding down **[SPEECH LOCK]** turns ON the Speech function.

[P.LOCK] Switch (Default: ALL)

Selects the action of the **[P.LOCK]** key.

① **[POWER]** and **[P.LOCK]** are not locked.

- ALL: All controls are disabled.
- KEY: All controls except **[DIAL A]** and **[DIAL B]** are disabled.

① When you hold down **[P.LOCK]** for 1 second, the display backlight is turned OFF.

① When "KEY" is selected and while the Panel Lock is activated, rotating **[DIAL A]** or **[DIAL B]** turns ON the display backlight.

MAIN DIAL Auto TS (Default: High)

Sets the Auto Tuning Step function for **[MAIN DIAL]**.

When rapidly rotating **[MAIN DIAL]**, the tuning step automatically changes according to the rotation speed.

- OFF: Auto tuning step is turned OFF.
- LOW: Approximately 2 times faster.
- HIGH: Approximately 5 times faster when the tuning step is set to 1 kHz or smaller steps.
Approximately 2 times faster when the tuning step is set to 1 kHz or larger steps.

AFC Limit (Default: ON)

Selects whether or not to limit the frequency shift range for the AFC function.

- OFF: Does not limit the frequency shift range.
- ON: Limits the frequency shift range according to the table below.

Receive mode	Filter width	AFC range limit
DIGITAL	5 kHz	±3.5 kHz
	10 kHz	±7 kHz
FM/DIGITAL	7 kHz	±5 kHz
	15 kHz	±10 kHz
FM	50 kHz	±25 kHz
WFM	200 kHz	±100 kHz

[NOTCH] Switch (AM) (Default: Auto/Manual)

[NOTCH] Switch (SSB) (Default: Auto/Manual)

Selects the Notch function type in the SSB or AM mode.

- Auto: Only the Auto notch filter (AN).
- Manual: Only the Manual notch filter (MN).
- Auto/Manual: Both the Auto and Manual notch filters.

SSB/CW Synchronous Tuning (Default: OFF)

Turns the Displayed Frequency Shift function ON or OFF.

This function automatically shifts the frequency to match the CW pitch when the operating mode is toggled between SSB and CW.

- OFF: Stays on the frequency even when the operating mode is toggled between SSB and CW.
- ON: Shifts the frequency when the operating mode is toggled between SSB and CW, to keep receiving the signal.

CW Normal Side (Default: LSB)

Selects the carrier point in the CW normal mode.

- LSB: The LSB side.
- USB: The USB side.

Screen Capture [POWER] Switch (Default: OFF)

Assigns the Screen Capture function to **[POWER]**.

- OFF: **[POWER]** does not act as the Screen Capture key.
- ON: **[POWER]** acts as the Screen Capture key.

Function (Continued)**Screen Capture File Type** (Default: PNG)

Selects the file format for the Screen Capture function.

- Options: PNG or BMP

Keyboard Type (Default: Full Keyboard)

Sets the keyboard entry type to Ten-key or Full Keyboard.

- Ten-key: Ten-key type
- Full Keyboard: Full Keyboard type
 - ① You can enter upper case letters, lower case letters, numbers, some symbols and spaces with this type.

① When the edit screen is displayed, push **QUICK** to open the QUICK menu and select the desired keyboard type.

Full Keyboard Layout (Default: English)

You can choose the keyboard type to the language.

Options: English, German and French

*For the France version, the default is "French."

REF Adjust

Calibrates the internal reference frequency (10 MHz).

- Range: 0 ~ 100%

Digital Set

MENU » **SET > Digital Set**

Digital Monitor (Default: Auto)

Selects the receive mode when **DIAL B** is pushed in the DIGITAL mode.

- Auto: Receives in the DIGITAL mode or the FM mode, depending on the received signal.
- Digital: Receives in the DIGITAL mode.
- Analog: Receives in the FM mode.

Digital Mode Select (Default: (All modes selected))

Selects the DIGITAL mode options. Only checked modes are displayed as the option on the [MODE] screen.

- Options: D-STAR, P25, dPMR, NXDN-N, NXDN-VN and DCR

RX History Log > **RX History Log** (Default: OFF)

You can store the Received Call logs on to an SD card in CSV format.

- OFF: Does not store the log.
- ON: Stores the logs.

Digital Set (Continued)RX History Log > CSV Format > **Separator/Decimal** (Default: Sep [,] Dec [.])

Selects the separator and the decimal character for the CSV format.

- Sep [,] Dec [.] : Separator is “,” and Decimal is “.”
 - Sep [.] Dec [.] : Separator is “.” and Decimal is “.”
 - Sep [.] Dec [,] : Separator is “.” and Decimal is “,”
- ① The default value differs, depending on the receiver version.

RX History Log > Date > **Date** (Default: yyyy/mm/dd)

Selects the date format between “yyyy/mm/dd,” “mm/dd/yyyy” and “dd/mm/yyyy.” (y: year, m: month, d: day)

① * The default value may differ, depending on the receiver version.

D-STAR Standby Beep (Default: ON)

Turns the Standby Beep function ON or OFF.

- OFF: Turns OFF the function.
- ON: Sounds a beep after a received signal disappears, in the DV (D-STAR) mode.

D-STAR Auto Detect (Default: OFF)

Turns the DV (D-STAR) mode Automatic Detect function ON or OFF.

- OFF: Turns OFF the function. The receive mode is fixed to the DV mode.
- ON: Automatically and temporarily switches to the FM mode, when an FM signal is received in the DV mode.

RX Record (D-STAR RPT) (Default: All)

Records the received call history when a DV (D-STAR) signal is received.

- ALL: Records up to 50 calls.
- Latest Only: Records only the last call.

D-STAR EMR AF Level (Default: 20%)

Set the audio output level for when an EMR (Enhanced Monitor Request) communication signal is received in the DV (D-STAR) mode.

Range: 0 ~ 100%

- ① When an EMR signal is received, the audio will be heard at the set level, or the [AF GAIN] level, whichever is higher.
- ② To disable the setting, set it to “0%.”

Fast Unmute (NXDN) (Default: ON)

Selects the mute state for the Encryption function in the NXDN mode. This function releases the mute without confirming whether or not the encryption key matches.

- OFF: Releases the mute after confirming the encryption key matches.
- ON: Releases the mute without confirming whether or not the encryption key matches.

① If you want to prevent cutting off the beginning of the

Connectors

MENU » **SET > Connectors**

Phones Level Ratio (Default: 1.00)

Sets the output ratio of the speaker output level and headphones output level.

- Range: 0.40 ~ 2.00

AF/IF > Output Select (Default: AF)

Selects the signal output from [AF/IF].

- AF: The demodulated AF signal is output.
- IF: A 12 kHz IF signal is output.
 - ① You can listen to the Digital Radio Mondiale (DRM) broadcast with an application software receiver if it is installed into your PC.

AF/IF > AF Output Level (Default: 50%)

Sets the AF output level of [AF/IF].

- Range: 0 ~ 100%
- ① At 50% (default), the output level is 200 mV (RMS).

AF/IF > AF SQL (Default: OFF (OPEN))

Selects whether or not to output the audio from [AF/IF], according to the squelch and signal levels.

- OFF(OPEN): The squelch is always opened regardless of the squelch and signal levels.
- ON: The squelch opens and closes, according to the squelch and signal levels.

AF/IF > AF Beep/Speech... Output (Default: OFF)

Sets the Beep and Speech audio output status of [AF/IF].

- OFF: The beep and speech audio are not output from [AF/IF].
- ON: The beep and speech audio are output from [AF/IF].

AF/IF > IF Output Level (Default: 50%)

Sets the IF output level of [AF/IF].

- Range: 0 ~ 100%
- ① At 50% (default), the output level is 200 mV (RMS).

USB (Front) > Output Select (Default: AF)

Selects the signal output from [USB] on the front panel.

- AF: The demodulated AF signal is output.
- IF: A 12 kHz IF signal is output.
 - ① You can listen to the Digital Radio Mondiale (DRM) broadcast with the application software receiver that is installed into your PC.

USB (Front) > AF Output Level (Default: 50%)

Sets the AF output level of [USB] on the front panel.

- Range: 0 ~ 100%

USB (Front) > AF SQL (Default: OFF (OPEN))

Selects whether or not to output the audio from [USB] on the front panel, according to the squelch and signal levels.

- OFF(OPEN): The squelch is always opened regardless of the squelch and signal levels.
- ON: The squelch opens and closes, according to the squelch and signal levels.

USB (Front) > AF Beep/Speech... Output (Default: OFF)

Sets the Beep and Speech audio output status of [USB] on the front panel.

- OFF: The beep and speech audio are not output from [USB] on the front panel.
- ON: The beep and speech audio are output from [USB] on the front panel.

USB (Front) > IF Output Level (Default: 50%)

Sets the IF (12 kHz) output level of [USB] on the front panel.

- Range: 0 ~ 100%

USB (Front) > Serial Function (Default: FSK Decode)

Selects the signal output from [USB] on the front panel.

- FSK Decode: An FSK decoded signal is output.
- D-STAR Data: A D-STAR data is output.

USB (Front) > FSK Decode Baud Rate (Default: 9600)

Selects the data transfer rate (Baud rate) of decoded FSK signals from [USB] on the front panel.

- Options: 4800, 9600, 19200 or 38400 (bps)

USB (Front) > D-STAR Data Baud Rate (Default: 9600)

Selects the data transfer rate (Baud rate) of decoded D-STAR data from [USB] on the front panel.

- Options: 4800 or 9600 (bps)

USB (Rear) > Output Select (Default: AF)

Selects the signal output from [USB] on the rear panel.

- AF: The demodulated AF signal is output.
- IF: A 12 kHz IF signal is output.
 - ① You can listen to the Digital Radio Mondiale (DRM) broadcast with the application software receiver that is installed into your PC.

USB (Rear) > AF Output Level (Default: 50%)

Sets the AF output level of [USB] on the rear panel.

- Range: 0 ~ 100%
- ① At 50% (default), the output level is 200 mV (RMS).

Connectors (Continued)

USB (Rear) > AF SQL (Default: OFF (OPEN))

Selects whether or not to output the audio from [USB] on the rear panel, according to the squelch and signal levels.

- OFF(OPEN): The squelch is always opened regardless of the squelch and signal levels.
- ON: The squelch opens and closes, according to the squelch and signal levels.

USB (Rear) > AF Beep/Speech... Output (Default: OFF)

Sets the Beep and Speech audio output status of [USB] on the rear panel.

- OFF: The beep and speech audio are not output from [USB] on the rear panel.
- ON: The beep and speech audio are output from [USB] on the rear panel.

USB (Rear) > IF Output Level (Default: 50%)

Sets the IF (12 kHz) output level of [USB] on the rear panel.

- Range: 0 ~ 100%

USB (Rear) > Serial Function (Default: FSK Decode)

Selects the signal output from [USB] on the rear panel.

- FSK Decode: An FSK decoded signal is output.
- D-STAR Data: A D-STAR data is output.

USB (Rear) > FSK Decode Baud Rate (Default: 9600)

Selects the data transfer rate (Baud rate) of decoded FSK signals from [USB] on the rear panel.

- Options: 4800, 9600, 19200 or 38400 (bps)

USB (Rear) > D-STAR Data Baud Rate (Default: 9600)

Selects the data transfer rate (Baud rate) of decoded D-STAR data from [USB] on the rear panel.

- Options: 4800 and 9600 (bps)

LAN > Output Select (Default: AF)

Selects the signal output from [LAN].

- AF: The demodulated AF signal is output.
- IF: A 12 kHz IF signal is output.
 - ① You can listen to the Digital Radio Mondiale (DRM) broadcast with an application software receiver that is installed into your PC.

LAN > AF SQL (Default: OFF (OPEN))

Selects whether or not to output the audio from [LAN], according to the squelch and signal levels.

- OFF(OPEN): The squelch is always opened regardless of the squelch and signal levels.
- ON: The squelch opens and closes, according to the squelch and signal levels.

LAN > AF Speech Output (Default: OFF)

Sets the Speech audio output status of [LAN].

- OFF: The speech audio is not output from [LAN].
 - ON: The speech audio is output from [LAN].
- ① You should set the "AF SQL" item to "AF."

CI-V > CI-V Baud Rate (Default: Auto)

Selects the CI-V data transfer rate.

- Options: 4800, 9600, 19200 (bps) or Auto
- ① When "Auto" is selected, the baud rate is automatically set, according to the data rate of the connected controller.

CI-V > CI-V Address (Default: 96h)

Selects the CI-V address.

- Range: 02h ~ 96h ~ DFh
- ① "96h" is the default address of the IC-R8600.

CI-V > CI-V Transceive (Default: ON)

Turns the Transceive function ON or OFF.

- OFF: The status is not output.
- ON: The status is output.

CI-V > USB/LAN→REMOTE Transceive Address (Default: 00h)

Sets the address used to remotely control the receiver using the optional RS-R8600, through the [USB] or [LAN] port.

The external equipment control signal is output from the [REMOTE] port.

- Range: 00h ~ DFh

TIP: When multiple devices are connected.

The default transceive address is "00h." To control dedicated equipment when several devices are connected, set the same CI-V address.

CI-V > CI-V USB (Front) Baud Rate (Default: Auto)

Selects the CI-V data transfer rate for [USB] on the front panel.

- Options: 4800, 9600, 19200, 38400, 57600, 115200 (bps) or Auto
- ① When "Auto" is selected, the baud rate is automatically set according to the data rate of the connected controller.

CI-V > CI-V USB (Front) Echo Back (Default: OFF)

Turns the Data Echo Back function ON or OFF, when remotely controlling through the [USB] CI-V port.

- OFF: Turns OFF the function.
- ON: Turns ON the function.

Connectors (Continued)

CI-V > **CI-V USB (Rear) Port** (Default: Unlink from [REMOTE])

Selects the internal connection type between the [USB] port on the rear panel and the [REMOTE] CI-V port.

- Link to [REMOTE]:
The [USB] port on the rear panel and the [REMOTE] CI-V port are internally connected.
- Unlink from [REMOTE]:
The [USB] port on the rear panel and [REMOTE] CI-V port are not internally connected. Each port functions independently. (duplex communication can be made.)

CI-V > **CI-V USB (Rear) Baud Rate** (Default: Auto)

Selects the CI-V data transfer rate (bps) for [USB] on the rear panel.

- Options: 4800, 9600, 19200, 38400, 57600, 115200 or Auto
- ① When "Auto" is selected, the baud rate is automatically set according to the data rate of the connected controller.
- ① This setting is valid only when the "CI-V USB Port" item is set to "Unlink from [REMOTE]."

CI-V > **CI-V USB (Rear) Echo Back** (Default: OFF)

Turns the Data Echo Back function ON or OFF, when remotely controlling through the [USB] CI-V port.

- OFF: Turns OFF the function.
- ON: Turns ON the function.
- ① This setting is valid only when the "CI-V USB Port" item is set to "Unlink from [REMOTE]."

External Meter Output (Default: Signal)

Selects the signal output from [METER].

- Signal: Signal strength.
- Signal+SQL: Signal strength and squelch level.

External Meter Level (Default: 50%)

Sets the voltage level output from [METER].

- Range: 0 ~ 100%
- ① 8 V DC is output at full scale (50%). (into a 10 kΩ load)

REF IN/OUT (Default: OFF)

Selects the receiver's reference frequency signal source.

- IN: Uses an external reference signal.
NOTE: SELECT "OFF" or "OUT" if you are not use a reliable external signal source.
When the input signal source level is too low, or the frequency precision is not high, the frequency readout blinks and the receiver does not function correctly.
- OFF: Does not input/output the reference signal.
- OUT: Outputs the internal reference signal.

Network

MENU » SET > Network

DHCP (Valid after Restart) (Default: ON)

Turns the DHCP function ON or OFF.

- OFF: Uses the static IP address.
- ON: Uses the DHCP function.
If a DHCP server is in your network environment, the IP address is automatically obtained.
- ① This setting takes effect after restart.

IP Address (Valid after Restart) (Default: 192.168. 0. 10)

Sets the static IP address.

- ① This setting is valid when "OFF" is selected the [DHCP (Valid after Restart)] item.
- ① This setting takes effect after restart.

Subnet Mask (Valid after Restart) (Default: 255.255.255.0 (24bit))

Sets the subnet mask to connect to your PC or LAN (Local Area Network), through the Ethernet. Rotate **(DIAL C)** to set.

- Range: 128.0.0.0 (1 bit) ~ 255.255.255.252 (30 bit)
- ① This setting takes effect after restart.

Default Gateway (Valid after Restart) (Default: . . .)

When you remotely control the IC-R8600 using the optional RS-R8600, a default gateway setting is required.

- ① This setting is valid when "OFF" is selected the [DHCP (Valid after Restart)] item.
- ① This setting takes effect after restart.

Primary DNS Server (Valid after Restart) (Default: . . .)

If there are two DNS server addresses, enter the primary DNS server address.

- ① This setting takes effect after restart.

2nd DNS Server (Valid after Restart) (Default: . . .)

If there are two DNS server addresses, enter the secondary DNS server address.

- ① This setting takes effect after restart.

Network (Continued)

Network Name

When you remotely control the IC-R8600 using the optional RS-R8600, enter a network name.

- ① "." (period) cannot be used for the first character.
- ① Push **[QUICK]** to change the keyboard type.
- ① Refer to page 1-7 for the character entering.

Network Control (Valid after Restart) (Default: OFF)

When you remotely control the IC-R8600 using the optional RS-R8600, select "ON."

- OFF: Turn OFF the function.
- ON: Turn ON the function.
- ① This setting takes effect after restart.

Power OFF Setting (for Remote Control)

(Default: Shutdown only)

When you remotely control the IC-R8600 using the optional RS-R8600, select "ON."

- Shutdown only: Shuts down immediately.
- Standby/Shutdown: Displays the SHUTDOWN dialog before shutting down.

Control Port (UDP) (Valid after Restart)

(Default: 50001)

When you remotely control the IC-R8600 using the optional RS-R8600, set a port number for the control signal transfers between the IC-R8600 and the remote station.

- Set the same port number to the PC.
- ① This setting takes effect after restart.

Serial Port (UDP) (Valid after Restart)

(Default: 50002)

When you remotely control the IC-R8600 using the optional RS-R8600, set a port number for the serial data transfers between the IC-R8600 and the remote station.

- ① This setting takes effect after restart.

Audio Port (UDP) (Valid after Restart)

(Default: 50003)

When you remotely control the IC-R8600 using the optional RS-R8600, set a port number for the audio signal transfers between the IC-R8600 and the remote station.

- ① This setting takes effect after restart.

Internet Access Line (Valid after Restart)

(Default: FTTH)

When you remotely control the IC-R8600 using the optional RS-R8600, set the port number for the audio signal transfers between the IC-R8600 and the remote station.

- Set the same port number to the remote station.
- ① This setting takes effect after restart.

Network user1 > Network User1 ID

Network user2 > Network User2 ID

When you remotely control the IC-R8600 using the optional RS-R8600, enter a user name.

- ① Push **[QUICK]** to change the keyboard type.
- ① Refer to page 1-7 for the character entering.

Network user1 > Network User1 Password

Network user2 > Network User2 Password

Enter a password for each user.

- ① Push **[QUICK]** to change the keyboard type.
- ① Refer to page 1-7 for the character entering.

Network user1 > Network User1 Administrator

Network user2 > Network User2 Administrator

(Default: NO)

Sets the user as the administrator.

Only authorized users can disconnect the communication between the remote IC-R8600 and the optional RS-R8600.

- NO: Not authorized.
- YES: Authorized.

Network Radio Name

(Default: IC-R8600)

When you remotely control the IC-R8600 using the optional RS-R8600, enter a nickname.

- ① Push **[QUICK]** to change the keyboard type.
- ① Refer to page 1-7 for the character entering.

Display

MENU » **SET > Display**

LCD Backlight (Default: 50%)

Sets the LCD backlight brightness.
• Range: 0 (dark) ~ 100% (bright)

LED Bright (Default: 80%)

Sets the LED brightness.
• Range: 0 (dark) ~ 100% (bright)

Display Type (Default: A)

Sets the display background type to A or B.
• A: Display background color is black.
• B: Display background color is blue.

Meter Peak Hold (Default: ON)

Turns the Meter Peak Hold function ON or OFF.
• OFF: Does not hold the peak level.
• ON: Holds the peak level on the signal meter display for 0.5 seconds.

Memory Name (Default: ON)

Turns the Memory name display in the Memory mode ON or OFF.
• OFF: Memory name is not displayed, even if entered.
• ON: The entered Memory name is displayed above the frequency display.

Group Name Popup (Default: ON)

Select whether or not to display the group name when you change the memory channel group.
• OFF: The group name is not displayed.
• ON: The group name is displayed.

MN-Q Popup (MN OFF→ON) (Default: ON)

Selects whether or not to display the Manual Notch filter width when you select the Manual Notch.
• OFF: The Manual Notch filter width is not displayed.
• ON: The Manual Notch filter width is displayed.

BW Popup (PBT) (Default: ON)

Selects whether or not to display the digital TWIN PBT shift value while rotating **TWIN PBT CLR**.
• OFF: The the PBT and center shift value are not displayed.
• ON: The the PBT and center shift value are displayed.

BW Popup (FIL) (Default: ON)

Selects whether or not to display the digital IF filter width and shift value when you change the IF filter.
• OFF: The IF filter width and shift value are not displayed.
• ON: The IF filter width and shift value are displayed.

RX Popup (Default: Normal)

Selects whether or not to display the information included in the received digital signal such as call sign, caller's ID, code and so on, when you receive a digital signal.

- OFF: The information is not displayed.
- Normal: The information is displayed for approximately 3 seconds.
- RX Hold: The information is displayed until an operation is performed.
- Hold: The information is displayed and remains, even an operation is performed.

P25 RX ID Display (Default: Dec)

Selects the P25 Talk-group ID display type.

- Dec: In Decimal.
- Hex: In Hexadecimal.

Screen Saver (Default: 60min)

Sets the Screen Saver function.

This function activates and automatically turns OFF the screen* when no operation is performed for the preset period of time.

- OFF: Turns OFF the function.
- 15min: Activates after 15 minutes with no operation.
- 30min: Activates after 30 minutes with no operation.
- 60min: Activates after 60 minutes with no operation.

***POWER** indicator blinks.

Opening Message (Default: ON)

Selects whether or not to display the opening message (including the opening comment) at power ON.

- OFF: Opening message is not displayed.
- ON: Opening message is displayed.

Opening Comment

Enter the opening comment displayed with the opening message at power ON.

- ① Push **QUICK** to change the keyboard type.
- ① Refer to page 1-7 for the character entering.

Display Language (Default: English)

Sets the display language.

- English: Displays in English.
- Japanese: Displays in Japanese.
- ① This item is not displayed when "English" is selected in the "System Language" item.

System Language (Default: English)

Sets the system language.

- English: Displays in English.
- Japanese: Displays in Japanese.
- ① If you set the language to English, all Japanese characters (such as memory name) you entered are garbled. But the display returns to normal when you change to Japanese again.

Time Set

MENU » **SET > Time Set**

Date/Time > **Date** (Default: 2000/01/01)

Sets the date* (Year/Month/Day).

- Settable range: 2000/01/01 ~ 2099/12/31

① The day of the week is automatically set.

② If the NTP Function is ON and receiver is connected to Internet, these items are automatically set.

Date/Time > **Time** (Default: 0:00)

Sets the current time.

- Settable range: 0:00 ~ 23:59

① The time is displayed in the 24 hour format.

② If the NTP Function is ON and receiver is connected to Internet, these items are automatically set.

Date/Time > <<**NTP TIME SYNC**>>

Touch to synchronize the internal clock to the NTP server.

- Automatically obtains the current time from the NTP server.

Date/Time > **NTP Function** (Default: ON)

Automatically obtains the current time from the NTP server.

- OFF: Turn OFF the function.
- ON: Use the function. (An internet access is necessary.)

Date/Time > **NTP Server Address** (Default: time.nist.gov)

Sets the NTP server address.

① Do not change this setting, unless it is necessary.

② Refer to page 1-7 for the character entering.

UTC Offset (Default: + 0:00)

Sets the UTC offset time.

- Range: -14:00 to +14:00 (in 5 minute steps)

SD Card

MENU » **SET > Time Set**

Load Setting

Selects the saved data file to load.

① See "Using An SD Card" in Section 7 for data load details.

Save Setting

Saves the setting data onto an SD card.

① See "Using An SD Card" in Section 7 for data write details.

Save Form (Default: Now Ver)

Selects the save version format to save the Memory channels, the Set mode settings, and so on to an SD card.

- Now Ver: Saves the setting data in the current version format.
- Old Ver (1.00 - 1.02): Saves the setting data in the older version format (1.00 - 1.02).

① If you select "Old Ver (1.00 - 1.02)," a function that is added when the receiver's firmware format is updated will not be saved.

② You cannot load a setting file that is saved in the current version format to an earlier firmware version IC-R8600.

NOTE:

- If you select "Old Ver (xxx - xxx)," a function that is added when the receiver's firmware format is updated will not be saved.
- You cannot write a setting file that is saved in the current version format to an earlier firmware version IC-R8600.

SD Card (Continued)

SD Card Info

Displays the SD card capacity and the time remaining for recording.

Screen Capture View

Displays the selected screen capture.

① See "Screen Capture function" (p. 5-11) for details.

Firmware Update

Enters the Firmware Update mode.

① See "Updating the firmware" (p. 13-1) for details.

Format

Formats the SD card.

① See "Formatting an SD card" (p. 7-2) for details.

Unmount

Unmounts the SD card.

NOTE:

Before you remove a card when the receiver is ON, be sure to electrically unmount it (p. 7-1). Otherwise the data may be corrupted or deleted.

Others

MENU » **SET > Other**

Information > **Version**

Displays the firmware version.

Information > **MAC Address**

Displays the receiver's MAC address.

Clone > **Clone Mode**

Touch to enter the cloning mode.

① The cloning mode is cancelled on restart.

Touch Screen Calibration

Touch to adjust the touch screen.

① Touch the white dots that sequentially appears on the screen.

<<**BER Measurement Start/Stop**>>

Touch to enter or quit the BER Measurement mode.

- "BER" is displayed while in the measurement mode.
- Push **QUICK** to select the testing signal type (Clock/Data or UART) and measurement mode (General or P25 specific).

Reset > **Partial Reset**

Touch to return all the settings to their factory defaults except the memory channels.

① See "Resetting" (p. 12-2) for details.

Reset > **All Reset**

Touch to return all the settings to their factory defaults, and clears all the memory channels.

① See "Resetting" (p. 12-2) for details.

Cleaning



DO NOT use harsh solvents such as benzine or alcohol when cleaning, because they will damage the receiver surfaces.



If the receiver becomes dusty or dirty, wipe it clean with a dry, soft cloth.

Replacing fuse

If a fuse blows, or the receiver stops functioning, find and repair the cause of the problem. Then replace the damaged fuse with a new, adequately rated fuse.

The fuses are installed in the DC power cable and the circuitry in the body, to protect the receiver.

- DC power cable fuses3 A/125 V
- Circuitry fuseATC 3 A/32 V

⚠ WARNING!

- Disconnect the DC power cable from the receiver before replacing the fuse.
- **NEVER** use fuses that are not specified.

CAUTION: When you remove a fuse, use longnose pliers to protect your fingers and the fuse holders.

◇ DC power cable fuses

See the following illustration to replace the blown DC power cable fuse.

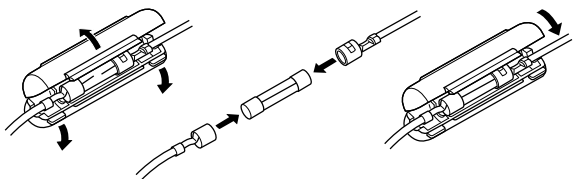

3 A fuses

◇ Circuitry fuse

1. Remove the 10 screws, then remove the cover.

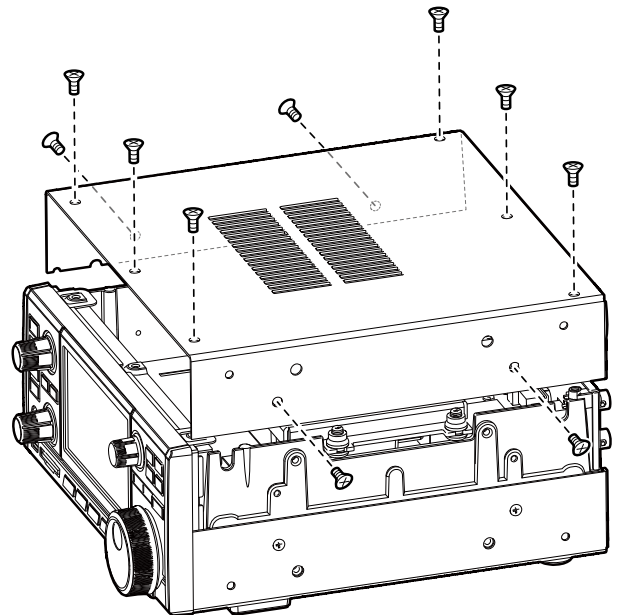

2. Replace the circuitry fuse as shown below.

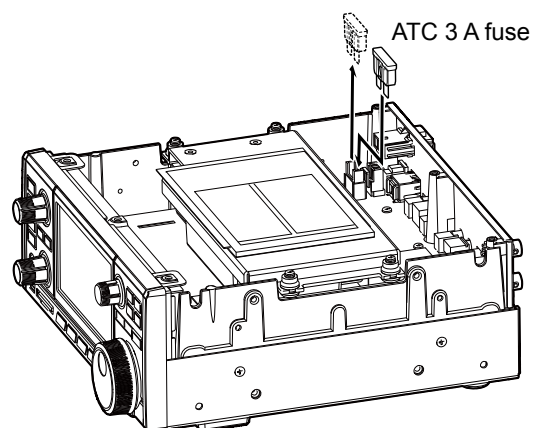

3. Replace the cover and the screws.

Resetting

Occasionally, erroneous information may be displayed. This may be caused by static electricity or by other factors.

If this problem occurs, turn OFF the receiver. After waiting a few seconds, turn ON the receiver.

If the problem still exists, perform a Partial reset as described below.

If the problem still exists after a Partial reset, perform an All reset as described to the right.

NOTE: An All reset clears all data and returns all settings to their factory defaults. Save memory channel content, setting status, and so on, onto an SD card before doing an All reset. (p. 7-2)

◇ Partial reset

A Partial reset resets operating settings to their default values (Timer setting, NTP Server Address, Lower and upper edge of the spectrum scope, Set mode items).

① Network settings, Reference frequency, Memory channels and Opening comments are not returned to their default value.

1. Open the RESET screen.

MENU » **SET > Others > Reset**

2. Touch “Partial reset.”

• The confirmation screen is displayed.

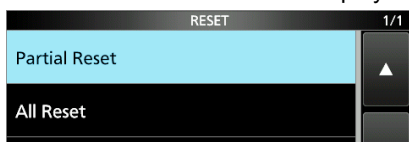

3. Touch [Yes].

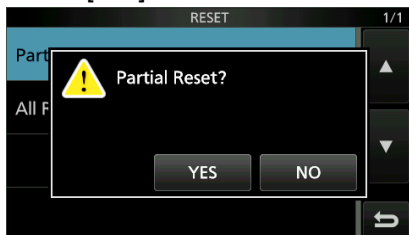

① After resetting, the IC-R8600 will automatically restart.

◇ All reset

All reset clears all data and returns all settings to their factory defaults.

1. Open the RESET screen.

MENU » **SET > Others > Reset**

2. Touch “All reset.”

• The confirmation screen is displayed.



3. Touch [NEXT].

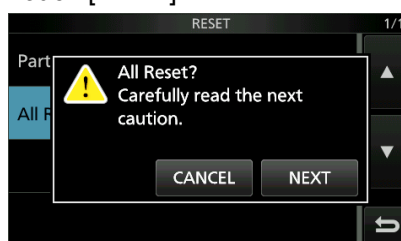

4. After carefully reading the displayed message, touch [YES] to perform the All reset.

① After resetting, the IC-R8600 will automatically restart.



TIP: When you cannot operate the screen

If a touch screen operation error or an unexpected operation occurs, you cannot enter the Set mode. In that case, perform the All reset as described below:

1. Turn OFF the receiver power.
2. While holding down **V/M** and **MW**, push **POWER**.

• "ALL RESET" is displayed on the opening screen.

① If "ALL RESET" is not displayed, repeat the above procedure again.

Touch screen calibration

When no screen action occurs, or a different function is activated after touching the screen, the touched point and the detected point may be different. In that case, the Touch screen calibration function helps to correct the touch screen sensing accuracy.

1. Open the OTHERS screen.

MENU » **SET > Others**

2. Touch "Touch Screen Calibration."

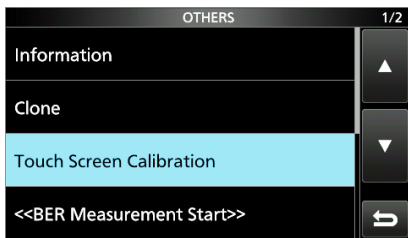

- A dot appears on the screen.

3. Touch the dot that appears on the screen.



- A new dot appears in another position.

4. Repeat step 3.
 - ①When the calibration is complete, the receiver returns to the OTHERS screen.
5. Touch the frequency readout or key on the screen, to check the sensing accuracy was corrected.

TIP: When the touch screen is not accurate, and you cannot access the OTHERS screen.

Do the following steps to correct the touch screen sensing accuracy.

1. Turn OFF the receiver power.
2. While holding down **MENU** and **EXIT**, push **POWER** to display the "Touch Window Calibration" screen, and then release **MENU** and **EXIT**.
3. Repeat the above touch screen calibration procedure.

Troubleshooting

The following chart is designed to help you correct problems which are not equipment malfunctions.

If you are unable to locate the cause of a problem, or solve it through the use of this chart, contact your nearest Icom Dealer or Service Center.

PROBLEM	POSSIBLE CAUSE	SOLUTION	REF.
Power does not come on when POWER is pushed.	Power cable is improperly connected.	Reconnect the power cable correctly.	p. 2-1
	The external power supply is turned OFF.	Turn ON the external power supply.	p. 2-1
	The DC power cable fuses or circuitry fuse is blown.	Find and repair the cause of the problem and then replace the damaged fuse with a new one.	p. 12-1
	The optional AD-55NS or SP-39AD is used but the supplied short connector is not connected.	Connect the supplied DC power short connector to [DC 13.8 V].	p. 2-1
No sound is heard from the speaker.	Audio level is too low or 0%.	Set the audio level to a higher level.	p. 3-1
	The squelch is too tight.	Set the squelch level to open the squelch.	p. 3-1
	The Tone/Code squelch or Digital squelch (D.SQL) is ON.	Turn OFF the Tone or Digital squelch.	p. 5-9
	A headphones is connected to [EX-SP] or [PHONES].	Disconnect the headphones.	p. 2-3
	The external speaker cable is disconnected.	Check the external speaker cable and repair it.	p. 2-3
Sensitivity is too low, and only strong signals can be heard.	The attenuator is activated.	Turn OFF the attenuator in the FUNCTION screen.	p. 5-1
	The RF gain is reduced. ("RFG" is displayed.)	Set [RF GAIN] to 100%. ("RFG" is disappeared.)	p. 3-1
	The antenna is defective or the coaxial cable is shorted or disconnected.	Repair the problem and then reconnect to the antenna connector.	p. 2-2
	You are using an antenna not suitable for the band you have selected.	Connect an antenna suitable for the operating frequency.	p. 2-2
	The selected antenna connector is incorrect.	Select the appropriate antenna connector.	pp. 2-2, 3-2 or 5-1
	The squelch is too tight.	Set the squelch level to open the squelch.	p. 3-1
Received audio in the SSB mode is unclear or distorted.	The incorrect sideband is selected.	Toggle between USB and LSB.	p. 3-1
	The Digital TWIN PBT function is activated.	Touch [PBT1] or [PBT2] for 1 second to clear the settings.	p. 5-2
The displayed frequency does not properly change by rotating MAIN DIAL .	The Dial Lock function is activated. (The [LOCK] indicator lights.)	Hold down SPEECH LOCK for 1 second to turn OFF the Lock function.	p. 3-3

Troubleshooting (Continued)

PROBLEM	POSSIBLE CAUSE	SOLUTION	REF.
The backlight is OFF. The touch panel does not work.	The [P.LOCK] indicator lights. (The Panel Lock function is activated.)	Push [P.LOCK] to turn OFF the Panel Lock function.	p. 3-3
Programmed scan does not start.	The same frequencies have been set in scan edge memory channels.	Set different frequencies in scan edge memory channels (P00A/P00B ~ P49A/P49B).	p. 8-2
Memory scan does not start.	There is no entered memory channel.	Enter at least 2 memory channels.	p. 8-2
	In the Memory mode, "BLANK" is displayed instead of frequency.	Write a frequency to the blank channel.	p. 8-2
Select memory scan does not start.	0 or only 1 memory channel is assigned as a Select channel.	Assign at least 2 memory channels as Select channels.	p. 9-8
Cannot hear the speech after pushing [SPEECH LOCK].	The speech level is too low.	Adjust the speech level in the Set mode.	p. 11-3
The frequency readout is blinking.	No external reference signal is input.	Check the [REF I/O 10MHz] connector setting or external signal source.	p. 11-7
"OVF" is displayed.	An excessively strong signal is received.	Set [RF GAIN] to a lower level.	p. 3-1
		Turn OFF the Preamp.	p. 5-1
		Turn ON the attenuator.	p. 5-1
The touch screen is not correctly working.	The touched point and the detected point may be different.	Calibrate the touch screen.	p. 12-3
Spectrum scope's sensitivity is too low, and only strong signals are displayed.	The reference level is too low.	Set the reference level to a higher level.	p. 4-4
When selecting a firmware file, "- No File -" is displayed.	No firmware file is not found on the SD card.	Copy the firmware file to the SD card.	p. 13-2
	The inserted SD card is not formatted.	Format the SD card with the built-in format function.	p. 7-2
	The firmware file name has been changed.	Download the firmware again.	p. 13-1
FSK (RTTY) signal is not demodulated.	The Mark or Space frequency is incorrect.	Set the appropriate Mark and Space frequencies.	p. 5-7
FSK (RTTY) signal is received but not decoded.	The shift setting is reversed.	Select the FSK-R (Reverse) mode.	p. 3-1

General

◇ About updating the firmware

You can update the IC-R8600's firmware using an SD card. Updating the firmware may add new functions and improves performance parameters.

You can download the latest firmware from the Icom website.

<http://www.icom.co.jp/world/index.html>

◇ Checking the firmware version

You can check the firmware version on the Opening screen when you turn ON the receiver.



The Main CPU's firmware version is displayed.

TIP: You can also check the firmware version on the INFORMATION screen.

MENU » **SET** > Others > Information > **Version**

Preparation

◇ Downloading the firmware file

Access the following URL and download the firmware file.

<http://www.icom.co.jp/world/index.html>

① These instructions are based on Microsoft® Windows® 7.

1. Click **[Support]**.



2. Click **“Firmware Updates/Software Downloads”**.



3. Click the desired firmware file link.

4. Read **“Regarding this Download Service”** carefully, and then click **[Agree]**.

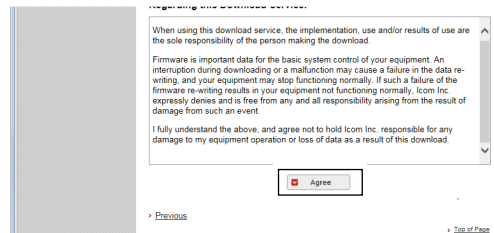

5. Click **“Save as”** in the displayed File Download dialog.

6. Select the location where you want to save the firmware, and then click **[Save]** in the displayed File Download dialog.

- The file starts downloading.
- The firmware and the firm utility are compressed in a “zip” format folder. Unzip it before use.

◇ Unzipping the firmware folder

1. Right-click the downloaded firmware folder (zip format).

- Right-click menu is displayed.

2. Click **“Extract All...”**

- After unzipping, a folder is created in the same location as the downloaded folder.

① In the “R8600_X*” folder, “8600XXXX.dat*” is created.

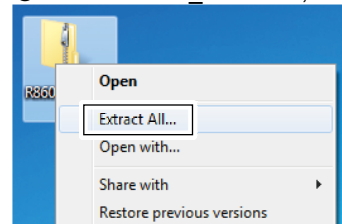

* X represents the release number.

Updating the firmware

IMPORTANT: To update the firmware, first format your SD card using the IC-R8600. (p. 7-2) Then copy the downloaded firmware data from your PC into the IC-R8600 folder that was created on the SD card.

CAUTION: NEVER turn OFF the receiver while updating the firmware. If you turn OFF the receiver, or if a power failure occurs while updating, the firmware will be damaged and you will have to send the receiver back to the nearest Icom distributor for repair. This type of repair is out of warranty, even if the receiver warranty period is still valid.

TIP: BE SURE to unzip the downloaded file. See “Unzipping the firmware folder (p. 13-1)” for details.

1. Copy the downloaded firmware data into the IC-R8600 folder on the SD card.

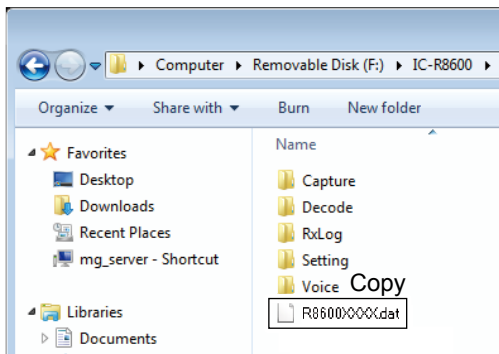

2. Insert the SD card into the receiver's [SD CARD] slot.
3. On the Set mode menu screen, display the SD CARD screen.

MENU » **SET > SD card**

4. Select “Firmware Update.”

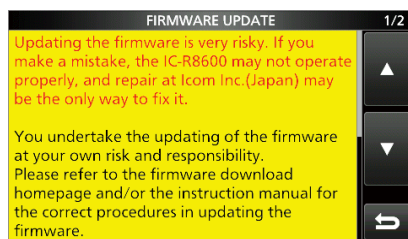
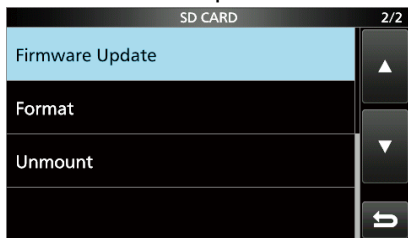

The Firmware Update Agreement screen

5. Touch [▲] or [▼] to scroll the screen.
6. After you read and agree with all the precautions, touch [YES].
 - The file select screen is displayed.

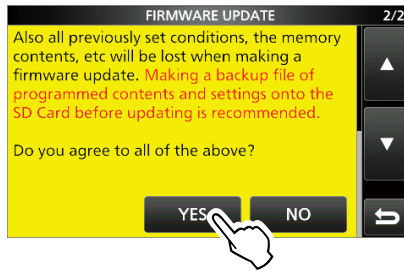

7. Touch the Firmware (Example: 8600XXXX.dat*).
 - The final confirmation screen is displayed.
 - Carefully read all the displayed precautions.



* X represents the release number.

8. After you read and agree with all the precautions, touch [YES] for 1 second.
 - The updating starts.
 - If you want to cancel the updating, touch [NO].



9. “Firmware updating has completed.” is displayed in the dialog.
 - The IC-R8600 will automatically restart.
 - After the updating finishes, the operating screen is displayed.

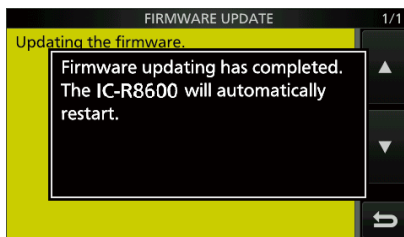

TIP: To check the firmware version after the updating, see “Checking the firmware version (p. 13-1)” for details.

◇ General

- Frequency coverage:

USA

0.010000 ~ 821.999999 MHz*
 851.000000 ~ 866.999999 MHz
 896.000000 ~ 3000.000000 MHz

France

0.135700 ~ 0.137800 MHz
 1.810000 ~ 1.850000 MHz
 3.500000 ~ 3.800000 MHz
 7.000000 ~ 7.200000 MHz
 10.100000 ~ 10.150000 MHz
 14.000000 ~ 14.350000 MHz
 18.068000 ~ 18.168000 MHz
 21.000000 ~ 21.450000 MHz
 24.890000 ~ 24.990000 MHz
 28.000000 ~ 29.700000 MHz
 50.000000 ~ 52.000000 MHz
 144.000000 ~ 146.000000 MHz
 430.000000 ~ 440.000000 MHz
 1240.000000 ~ 1300.000000 MHz
 2300.000000 ~ 2450.000000 MHz

Other than above

0.010000 ~ 3000.000000 MHz*

*Some frequency ranges are not guaranteed.

- Receiving modes:

SSB, CW, FSK, AM, FM, WFM and DIGITAL (D-STAR, P25, NXDN, dPMR and DCR)

- Number of memory channels:

2000 (in 100 groups)
 + 400 (Scan edges: 100 (50 pairs), Auto Memory Write: 200 and Scan Skip: 100)

- Power supply requirement:

13.8 V DC (±15%)

- Grounding system:

Negative

- Operating temperature range:

-10°C to +60°C, +14°F to +140°F

- Frequency stability:

Less than ±0.5 ppm

- Antenna connectors:

	[ANT1]	[ANT2]	[ANT3]
Frequency range	10 kHz ~ 3000 MHz	10 kHz ~ 30 MHz	10 kHz ~ 30 MHz
Impedance	50 Ω Unbalanced	50 Ω Unbalanced	500 Ω Unbalanced
Connector	N type	SO-239	RCA

- Frequency resolution:

1 Hz (minimum)

- Power consumption:

Standby 1.8 A

Maximum audio 2.0 A

- Dimensions (projections not included):

220 (W)×90 (H)×230 (D) mm, 8.7 (W)×3.5 (H)×9.1 (D) in

- Weight (approximately):

4.3 kg, 9.5 lb

◇ Receiver

- Receive system:

0.010000 ~ 29.999999 MHz Direct sampling
 30.000000 ~ 1099.999999 MHz Double superheterodyne
 1100.000000 ~ 3000.000000 MHz Triple superheterodyne
 122.88 MHz

- Sampling frequency:

- Intermediate frequencies:

Receive frequency (MHz)	1st IF (MHz)	2nd IF (MHz)	3rd IF (MHz)
0.010000 ~ 29.999999	—	—	—
30.000000 ~ 499.999999	778.7	46.35	—
500.000000 ~ 1099.999999	278.7	46.35	—
1100.000000 ~ 1499.999999	900 ~ 500.000001	278.7	46.35
1500.000000 ~ 3000.000000	1000 ~ 500	278.7	46.35

14 SPECIFICATIONS

◇ Receiver (continued)

• Sensitivity for all versions:

SSB/CW/FSK (BW: SSB/FSK=2.4 kHz, CW=500 Hz)

0.100000 ~ 1.799999 MHz	10 dB S/N	-6 dB μ (P.AMP ON)
1.800000 ~ 29.999999 MHz	10 dB S/N	-14 dB μ (P.AMP ON)
30.000000 ~ 1099.999999 MHz	10 dB S/N	-10 dB μ (P.AMP ON)
1100.000000 ~ 1999.999999 MHz	10 dB S/N	-10 dB μ (P.AMP ON)
2000.000000 ~ 3000.000000 MHz	10 dB S/N	-8 dB μ (P.AMP ON)

AM (BW=6 kHz)

0.100000 ~ 1.799999 MHz	10 dB S/N	16 dB μ (P.AMP ON)
1.800000 ~ 29.999999 MHz	10 dB S/N	8 dB μ (P.AMP ON)
30.000000 ~ 1099.999999 MHz	10 dB S/N	15 dB μ (P.AMP ON)
1100.000000 ~ 1999.999999 MHz	10 dB S/N	15 dB μ (P.AMP ON)
2000.000000 ~ 3000.000000 MHz	10 dB S/N	15 dB μ (P.AMP ON)

FM (BW=15 kHz)

28.000000 ~ 29.999999 MHz	12 dB SINAD	-6 dB μ (P.AMP ON)
30.000000 ~ 1099.999999 MHz	12 dB SINAD	-6 dB μ (P.AMP ON)
1100.000000 ~ 1999.999999 MHz	12 dB SINAD	-6 dB μ (P.AMP ON)
2000.000000 ~ 3000.000000 MHz	12 dB SINAD	-4 dB μ (P.AMP ON)

WFM (BW=180 kHz)

30.000000 ~ 1099.999999 MHz	12 dB SINAD	3 dB μ (P.AMP ON)
1100.000000 ~ 1999.999999 MHz	12 dB SINAD	3 dB μ (P.AMP ON)
2000.000000 ~ 3000.000000 MHz	12 dB SINAD	5 dB μ (P.AMP ON)

DIGITAL (D-STAR, NXDN, dPMR and DCR)

28.000000 ~ 1099.999999 MHz	1% BER	-2 dB μ (P.AMP ON)
1100.000000 ~ 1999.999999 MHz	1% BER	-2 dB μ (P.AMP ON)
2000.000000 ~ 3000.000000 MHz	1% BER	0 dB μ (P.AMP ON)

DIGITAL (P25)

28.000000 ~ 1099.999999 MHz	5% BER	-5 dB μ (P.AMP ON)
1100.000000 ~ 1999.999999 MHz	5% BER	-5 dB μ (P.AMP ON)
2000.000000 ~ 3000.000000 MHz	5% BER	-3 dB μ (P.AMP ON)

• Sensitivity for European versions (only for amateur band):

SSB (BW=2.4 kHz)

0.100000 ~ 2.999999 MHz	12 dB SINAD	10 dB μ V emf (P.AMP ON)
3.000000 ~ 29.999999 MHz	12 dB SINAD	0 dB μ V emf (P.AMP ON)
30.000000 ~ 3000.000000 MHz	12 dB SINAD	-6 dB μ V emf (P.AMP ON)

AM (BW=4 kHz)

0.100000 ~ 2.999999 MHz	12 dB SINAD	16 dB μ V emf (P.AMP ON)
3.000000 ~ 29.999999 MHz	12 dB SINAD	6 dB μ V emf (P.AMP ON)
30.000000 ~ 3000.000000 MHz	12 dB SINAD	0 dB μ V emf (P.AMP ON)

FM (BW=7 kHz)

3.000000 ~ 29.999999 MHz	12 dB SINAD	0 dB μ V emf (P.AMP ON)
30.000000 ~ 3000.000000 MHz	12 dB SINAD	-6 dB μ V emf (P.AMP ON)

• Selectivity:

SSB/FSK (BW=2.4 kHz)	More than 2.4 kHz/-3 dB	Less than 3.6 kHz/-60 dB
CW (BW=500 Hz)	More than 500 Hz/-3 dB	Less than 700 Hz/-60 dB
AM (BW=6 kHz)	More than 6.0 kHz/-3 dB	Less than 15.0 kHz/-60 dB
FM (BW=15 kHz)	More than 12.0 kHz/-6 dB	Less than 25.0 kHz/-60 dB
WFM	More than 180 kHz/-6 dB	

• Spurious and image rejection:

0.100000 ~ 29.999999 MHz	More than 70 dB
30.000000 ~ 1099.999999 MHz	More than 50 dB
1100.000000 ~ 2499.999999 MHz	More than 40 dB*
2500.000000 ~ 3000.000000 MHz	More than 40 dB*

*In the 1100 MHz and above frequencies, the 1st IF through is more than 35 dB.

*In the 2000 MHz and above frequencies, the 1st IF image rejection is more than 30 dB.

• Audio output power:

More than 2 W (8 Ω load, 10% distortion)

• AF output impedance:

8 Ω

①All stated specifications are typical and subject to change without notice or obligation.

Options

AD-55NS

AC ADAPTOR
• 15 V/2 A



① The shape may differ, depending on the version.

SP-23

EXTERNAL SPEAKER
• 4 W/8 Ω



① 145.0(W)×111.0(H)×282.5(D) mm
5.7(W)×4.4(H)×11.1(D) inch
(Projections not included)

SP-39AD

EXTERNAL SPEAKER
WITH BUILT-IN POWER SUPPLY
• 15 V/2 A
• 4 W/8 Ω

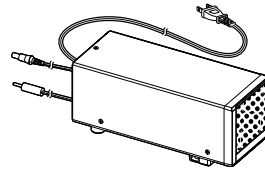

• Same height as the IC-R8600.
(Has a desktop stand.)

- CS-R8600 Cloning Software
- MB-123 Carrying handle

- RS-R8600 Remote control software

Approved Icom optional equipment is designed for optimal performance when used with an Icom receiver. Icom is not responsible for the destruction or damage to an Icom receiver in the event the Icom receiver is used with equipment that is not manufactured or approved by Icom.

Attaching the MB-123

The optional MB-123 carrying handle with the rubber feet is convenient for carrying the receiver.

1. Attach the rubber feet supplied with the MB-123 to the receiver.
① To firmly attach, push-in the center part of the rubber feet.
2. Attach the carrying handle using the supplied screws as shown to the right.

⚠ WARNING! NEVER use other than the screws supplied with the MB-123.

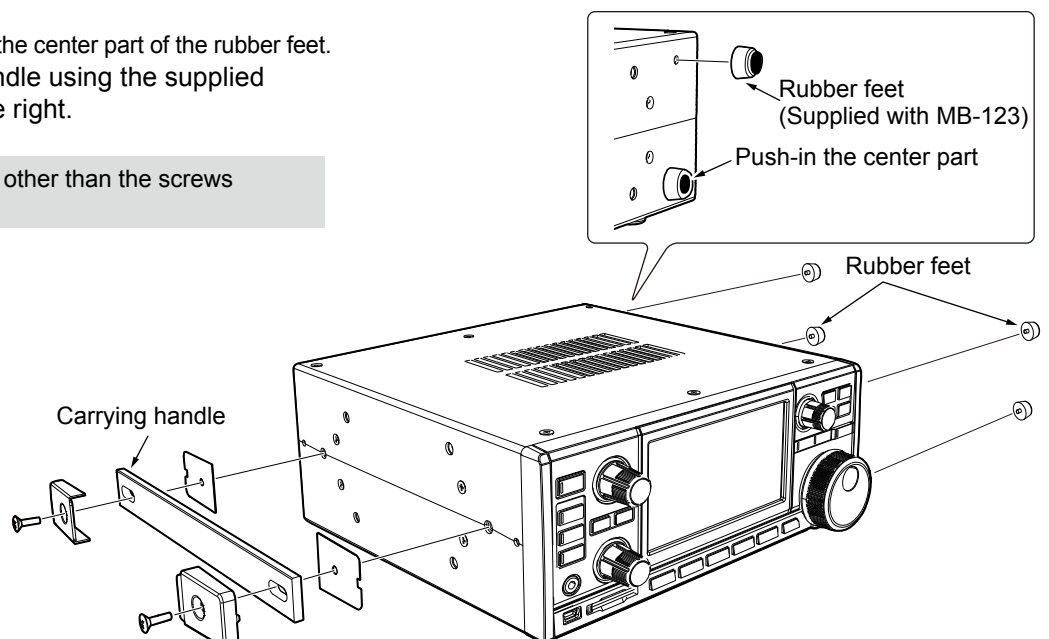

16 CONNECTOR INFORMATION

[10.7 MHz OUT]

Outputs the 10.7 MHz IF signal for an external detector/demodulator circuit.

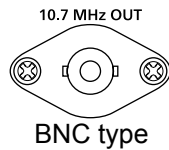

- Center frequency: 10.7 MHz
 - Band width*: 10 MHz
 - Impedance: 50 Ω (unbalanced)
 - Maximum output level: -10dBm (approximately)
- *The band width is fixed regardless of the digital PBT filter setting.

[REF I/O 10 MHz]

Outputs or inputs a 10 MHz reference frequency signal. You can change the signal direction in the Set mode.

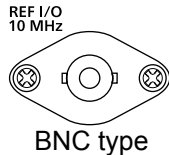

- Center frequency: 10 MHz
- Impedance: 50 Ω (unbalanced)
- Input/Output level: -10 dBm (approximately)
- Frequency stability: ±0.5 ppm (-10°C ~ +60°C, +14°F ~ +140 °F)

[I/Q OUT]

Outputs the Phase/Quadrature data which is processed by the FPGA. Connect a PC's USB port, to demodulate the DRM broadcast or Software Defined Radio SDR.



- Interface: USB (1.1/2.0), type B
- ① Icom does not provide any support regarding SDR technology and related software, except the inspection for the normality of output signal.
② The IQ driver and instruction guide will be released on the Icom website near future.
<http://www.icom.co.jp/world/index.html>

[AF/IF]

Outputs the demodulate audio signal or 12 kHz IF signal (unfiltered). The output level is fixed, regardless of the volume control position. (3.5 mm, 1/8 in (d))



- Impedance: 4.7 kΩ
 - Output level: 100 ~ 300 mV (RMS)
- ① You can select the output signal from AF or IF signals.

MENU » **SET > Connectors > AF/IF**

② The signal is also output from [USB] (front or rear) or [LAN].

[USB]

2 USB ports: Type B mini and Type B.

On the front panel On the rear panel



- Outputs the decoded FSK (RTTY) signal, or D-STAR data.
 - Outputs the demodulated signal or 12 kHz IF signal.
 - Remote control interface for optional RS-R8600.
 - Programming interface for the optional CS-R8600.
- ① You can change the port settings (FSK decode data/D-STAR data, AF/IF), baud rate and output level.

MENU » **SET > Connectors > USB (Front)**

MENU » **SET > Connectors > USB (Rear)**

② You can download the USB driver and installation guide from the Icom website.
<http://www.icom.co.jp/world/support/download/firm>

[LAN]

LED indication:

- ① LINK/ACT Lights: Cable connected.
Doesn't light: Cable not connected.
Blinks: While the line is communicating.
- ② Speed Lights: Communicating in 100BASE-TX
Doesn't lights: Communicating in 10BASE-T, or not connected.

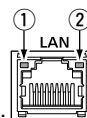

- Time synchronization by an NTP server.
 - Outputs the demodulated signal or 12 kHz IF signal.
 - Remote control interface for the optional RS-R8600.
- ① You can select the output signal from AF and IF signals.

MENU » **SET > Connectors > LAN**

[MUTE] JACK / [MUTE] SWITCH

Used to mute the receiver output. (3.5 mm, 1/8 in (d))

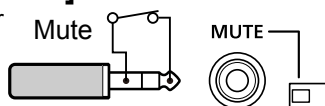

- When the [MUTE] is slid to left:**
When this terminal is grounded, the receive circuit is turned OFF.
① Use this function when you use the IC-R8600 with a transceiver.
② The sink current is approximately 1 mA at 8 V input.

When the Mute Switch is slid to right, the receiver enters to the Bit Error Rate (BER) Measurement mode for the maintenance purpose.

- When the [MUTE] is slid to right:**
Connect a BER counter. In the BER Measurement mode, the PN9 bit stream is output from this terminal.







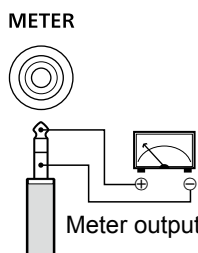

[METER]

Connects to an external meter. Outputs the received signal strength or squelch level. (3.5 mm, 1/8 in (d))

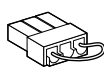
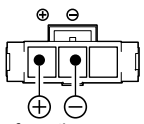
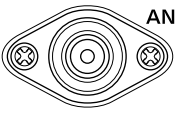
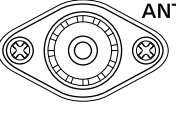

- Output voltage: 8 V (maximum)
 - Output impedance: 10 kΩ
- ① You can select the output signal from received signal strength and squelch levels.

MENU » **SET > Connectors**

<p>[REMOTE] Used to remotely controls the receiver with the CI-V format data. (3.5 mm, 1/8 in (d))</p> <p>① You can download the USB driver and installation guide from the Icom website. http://www.icom.co.jp/world/support/download/firm</p>	<p>REMOTE</p> 	<p>In the remote control mode, push [LOCAL] to return to the normal (Local) mode (LOCAL LED turns OFF). *Except [LOCAL], [POWER] and [P.LOCK].</p>
<p>[EXT-SP] Connects to an external speaker such as the optional SP-39AD. (3.5 mm, 1/8 in (d))</p>	<p>EXT-SP</p> 	<ul style="list-style-type: none"> • Output impedance: 4 ~ 8 Ω • Output level: More than 2 W at 10% distortion into an 8 Ω load.
<p>[DC IN] Connects to the optional SP-39AD.</p>	<p>DC IN</p> 	<p>When SP-39AD or AD-55NS is connected, connect the supplied DC short connector to [DC13.8V].</p> 
<p>[DC13.8V] Accepts the regulated DC power for 13.8 V DC (±15%), through the supplied DC power cable.</p>	<p>DC 13.8 V</p>  <p>View from the rear</p>	<p>WARNING! NEVER reverse the DC power cable polarity (Red= ⊕, Black= ⊖).</p>
<p>[ANT 1]</p> <p>N type</p>  <p>ANT 1</p> <p>0.01-3000 MHz</p>		<ul style="list-style-type: none"> • Frequency range: 10 kHz ~ 3000 MHz • Input impedance: 50 Ω (unbalanced) <p>① When the receive frequency is set to between 10 kHz and 29.999999 MHz, you can select the antenna on [ANT 1] ~ [ANT 3]. (p. 3-3)</p>
<p>[ANT 2]</p> <p>SO-239</p>  <p>ANT 2</p> <p>0.01-30 MHz</p>		<ul style="list-style-type: none"> • Frequency range: 10 kHz ~ 30 MHz • Input impedance: 50 Ω (unbalanced)
<p>[ANT 3] ① For a long wire antenna.</p>	<p>RCA type</p>  <p>ANT 3</p>	<ul style="list-style-type: none"> • Frequency range: 10 kHz ~ 30 MHz • Input impedance: 400 ~ 500 Ω (unbalanced)
<p>[AUX] A reserved terminal. No internal connection.</p>	<p>RCA type</p>  <p>AUX</p>	
<p>[PHONES] Connects to standard stereo headphones. (3.5 mm, 1/8 in (d))</p>	<p>PHONES</p> 	<ul style="list-style-type: none"> • Output impedance: 8 ~ 16 Ω • Output level: More than 50 mW (into an 8 Ω load)

ABOUT THE LICENSES

Information on the open source software being used by this product.

COPYRIGHT NOTICE, DISCLAIMER, and LICENSE:

If you modify libpng you may insert additional notices immediately following this sentence.

This code is released under the libpng license.

libpng versions 1.2.6, August 15, 2004, through 1.6.12, June 12, 2014, are Copyright (c) 2004, 2006-2014 Glenn Randers-Pehrson, and are distributed according to the same disclaimer and license as libpng-1.2.5 with the following individual added to the list of Contributing Authors:

Cosmin Truta

libpng versions 1.0.7, July 1, 2000, through 1.2.5, October 3, 2002, are Copyright (c) 2000-2002 Glenn Randers-Pehrson, and are distributed according to the same disclaimer and license as libpng-1.0.6 with the following individuals added to the list of Contributing Authors:

Simon-Pierre Cadieux
Eric S. Raymond
Gilles Vollant

and with the following additions to the disclaimer:

There is no warranty against interference with your enjoyment of the library or against infringement. There is no warranty that our efforts or the library will fulfill any of your particular purposes or needs. This library is provided with all faults, and the entire risk of satisfactory quality, performance, accuracy, and effort is with the user.

libpng versions 0.97, January 1998, through 1.0.6, March 20, 2000, are Copyright (c) 1998, 1999, 2000 Glenn Randers-Pehrson, and are distributed according to the same disclaimer and license as libpng-0.96, with the following individuals added to the list of Contributing Authors:

Tom Lane
Glenn Randers-Pehrson
Willem van Schaik

libpng versions 0.89, June 1996, through 0.96, May 1997, are Copyright (c) 1996, 1997 Andreas Dilger Distributed according to the same disclaimer and license as libpng-0.88, with the following individuals added to the list of Contributing Authors:

John Bowler
Kevin Bracey
Sam Bushell
Magnus Holmgren
Greg Roelofs
Tom Tanner

libpng versions 0.5, May 1995, through 0.88, January 1996, are Copyright (c) 1995, 1996 Guy Eric Schalnat, Group 42, Inc.

For the purposes of this copyright and license, "Contributing Authors" is defined as the following set of individuals:

Andreas Dilger
Dave Martindale
Guy Eric Schalnat
Paul Schmidt
Tim Wegner

The PNG Reference Library is supplied "AS IS". The Contributing Authors and Group 42, Inc. disclaim all warranties, expressed or implied, including, without limitation, the warranties of merchantability and of fitness for any purpose. The Contributing Authors and Group 42, Inc. assume no liability for direct, indirect, incidental, special, exemplary, or consequential damages, which may result from the use of the PNG

Reference Library, even if advised of the possibility of such damage.

Permission is hereby granted to use, copy, modify, and distribute this source code, or portions hereof, for any purpose, without fee, subject to the following restrictions:

1. The origin of this source code must not be misrepresented.
2. Altered versions must be plainly marked as such and must not be misrepresented as being the original source.
3. This Copyright notice may not be removed or altered from any source or altered source distribution.

The Contributing Authors and Group 42, Inc. specifically permit, without fee, and encourage the use of this source code as a component to supporting the PNG file format in commercial products. If you use this source code in a product, acknowledgment is not required but would be appreciated.

A "png_get_copyright" function is available, for convenient use in "about" boxes and the like:

```
printf("%s", png_get_copyright(NULL));
```

Also, the PNG logo (in PNG format, of course) is supplied in the files "pngbar.png" and "pngbar.jpg (88x31)" and "pngnow.png" (98x31).

Libpng is OSI Certified Open Source Software. OSI Certified is a certification mark of the Open Source Initiative.

The contributing authors would like to thank all those who helped with testing, bug fixes, and patience. This wouldn't have been possible without all of you.

Thanks to Frank J. T. Wojcik for helping with the documentation.

License for CMSIS-RTOS RTX Implementation

Copyright (c) 1999-2009 KEIL, 2009-2013 ARM Germany GmbH All rights reserved.

Redistribution and use in source and binary forms, with or without modification, are permitted provided that the following conditions are met:

- Redistributions of source code must retain the above copyright notice, this list of conditions and the following disclaimer.
- Redistributions in binary form must reproduce the above copyright notice, this list of conditions and the following disclaimer in the documentation and/or other materials provided with the distribution.
- Neither the name of ARM nor the names of its contributors may be used to endorse or promote products derived from this software without specific prior written permission.

THIS SOFTWARE IS PROVIDED BY THE COPYRIGHT HOLDERS AND CONTRIBUTORS "AS IS" AND ANY EXPRESS OR IMPLIED WARRANTIES, INCLUDING, BUT NOT LIMITED TO, THE IMPLIED WARRANTIES OF MERCHANTABILITY AND FITNESS FOR A PARTICULAR PURPOSE ARE DISCLAIMED. IN NO EVENT SHALL COPYRIGHT HOLDERS AND CONTRIBUTORS BE LIABLE FOR ANY DIRECT, INDIRECT, INCIDENTAL, SPECIAL, EXEMPLARY, OR CONSEQUENTIAL DAMAGES (INCLUDING, BUT NOT LIMITED TO, PROCUREMENT OF SUBSTITUTE GOODS OR SERVICES; LOSS OF USE, DATA, OR PROFITS; OR BUSINESS

INTERRUPTION) HOWEVER CAUSED AND ON ANY THEORY OF LIABILITY, WHETHER IN CONTRACT, STRICT LIABILITY, OR TORT (INCLUDING NEGLIGENCE OR OTHERWISE) ARISING IN ANY WAY OUT OF THE USE OF THIS SOFTWARE, EVEN IF ADVISED OF THE POSSIBILITY OF SUCH DAMAGE.

ZLIB DATA COMPRESSION LIBRARY

zlib 1.2.8 is a general purpose data compression library. All the code is thread safe. The data format used by the zlib library is described by RFCs (Request for Comments) 1950 to 1952 in the files <http://tools.ietf.org/html/rfc1950> (zlib format), [rfc1951](http://tools.ietf.org/html/rfc1951) (deflate format) and [rfc1952](http://tools.ietf.org/html/rfc1952) (gzip format).

All functions of the compression library are documented in the file `zlib.h` (volunteer to write man pages welcome, contact zlib@gzip.org). A usage example of the library is given in the file `test/example.c` which also tests that the library is working correctly. Another example is given in the file `test/minigzip.c`. The compression library itself is composed of all source files in the root directory.

To compile all files and run the test program, follow the instructions given at the top of `Makefile.in`. In short "`./configure; make test`", and if that goes well, "`make install`" should work for most flavors of Unix. For Windows, use one of the special makefiles in `win32/` or `contrib/vstudio/`. For VMS, use `make_vms.com`.

Questions about zlib should be sent to zlib@gzip.org, or to Gilles Vollant info@winimage.com for the Windows DLL version. The zlib home page is <http://zlib.net/>. Before reporting a problem, please check this site to verify that you have the latest version of zlib; otherwise get the latest version and check whether the problem still exists or not.

PLEASE read the zlib FAQ http://zlib.net/zlib_faq.html before asking for help.

Mark Nelson markn@ieee.org wrote an article about zlib for the Jan. 1997 issue of Dr. Dobbs's Journal; a copy of the article is available at <http://marknelson.us/1997/01/01/zlib-engine/>.

The changes made in version 1.2.8 are documented in the file `ChangeLog`.

Unsupported third party contributions are provided in directory `contrib/`.

zlib is available in Java using the `java.util.zip` package, documented at <http://java.sun.com/developer/technicalArticles/Programming/compression/>.

A Perl interface to zlib written by Paul Marquess pmqs@cpan.org is available at CPAN (Comprehensive Perl Archive Network) sites, including <http://search.cpan.org/~pmqs/IO-Compress-Zlib/>.

A Python interface to zlib written by A.M. Kuchling amk@amk.ca is available in Python 1.5 and later versions, see <http://docs.python.org/library/zlib.html>.

zlib is built into `td: http://wiki.tcl.tk/4610`.

An experimental package to read and write files in .zip format, written on top of zlib by Gilles Vollant info@winimage.com, is available in the `contrib/minizip` directory of zlib.

Notes for some targets:

- For Windows DLL versions, please see `win32/DLL_FAQ.txt`
- For 64-bit Irix, `deflate.c` must be compiled without any optimization. With
- O, one libpng test fails. The test works in

32 bit mode (with the `-n32` compiler flag). The compiler bug has been reported to SGI.

- zlib doesn't work with gcc 2.6.3 on a DEC 3000/300LX under OSF/1 2.1 it works when compiled with cc.

- On Digital Unix 4.0D (formerly OSF/1) on AlphaServer, the `cc` option `-std1` is necessary to get `gzprintf` working correctly. This is done by `configure`.

- zlib doesn't work on HP-UX 9.05 with some versions of `/bin/cc`. It works with other compilers. Use "make test" to check your compiler.

- `gzdopen` is not supported on RISCOS or BEOS.

- For PalmOS, see <http://palmzlib.sourceforge.net/>

Acknowledgments:

The deflate format used by zlib was defined by Phil Katz. The deflate and zlib specifications were written by L. Peter Deutsch. Thanks to all the people who reported problems and suggested various improvements in zlib; they are too numerous to cite here.

Copyright notice:

(C) 1995-2013 Jean-loup Gailly and Mark Adler

This software is provided 'as-is', without any express or implied warranty. In no event will the authors be held liable for any damages arising from the use of this software.

Permission is granted to anyone to use this software for any purpose, including commercial applications, and to alter it and redistribute it freely, subject to the following restrictions:

1. The origin of this software must not be misrepresented; you must not claim that you wrote the original software. If you use this software in a product, an acknowledgment in the product documentation would be appreciated but is not required.
2. Altered source versions must be plainly marked as such, and must not be misrepresented as being the original software.
3. This notice may not be removed or altered from any source distribution.

Jean-loup Gailly Mark Adler
jloup@gzip.org madler@alumni.caltech.edu
If you use the zlib library in a product, we would appreciate "not" receiving lengthy legal documents to sign. The sources are provided for free but without warranty of any kind. The library has been entirely written by Jean-loup Gailly and Mark Adler; it does not include third-party code.

If you redistribute modified sources, we would appreciate that you include in the file `ChangeLog` history information documenting your changes. Please read the FAQ for more information on the distribution of modified source versions.

	Symbols		
ΔF scan		9-5	
ΔF scan operation		9-5	
[NOTCH] Switch		11-3	
[P.LOCK] Switch		11-3	
[SPEECH/LOCK] Switch		11-3	
	Number		
2nd DNS Server (Valid after Restart)		11-7	
	A		
Auto Tuning Step function		3-3	
ABOUT THE INSTRUCTIONS		iv	
About the VFO and Memory modes		3-1	
AF Beep/Speech... Output.....		11-5, 11-6	
AFC function.....		5-5	
AFC Limit.....		11-3	
AF Output Level.....		11-5	
AF Speech Output.....		11-6	
AF SQL.....		11-5, 11-6	
AGC function		5-1	
AGC Time constant		5-1	
Antenna			
About antenna.....		2-2, 3-3	
Connecting an antenna		2-2	
Antenna connectors		14-1, 16-2	
Selecting the antenna		3-3, 5-1	
Attenuator.....		5-1	
Audio			
Audio tone		3-1	
Bass		11-2	
De-Emphasis.....		11-2	
HPF/LPF		11-2	
Tone Control.....		11-2	
Treble		11-2	
Volume level.....		3-1	
Audio Port (UDP).....		11-8	
Auto Memory Write scan		9-6	
	B		
Backlight dimmer		3-4	
Beep (Confirmation)		11-2	
Beep Level		11-2	
Beep Level Limit.....		11-2	
BER Measurement		11-10	
BW Popup (FILTER).....		11-9	
BW Popup (PBT).....		11-9	
	C		
CC		5-10	
CI-V			
Address		11-6	
Baud Rate		11-6	
Baud Rate (Front USB port)		11-6	
Baud Rate (Rear USB port)		11-7	
Echo Back (Front USB port)		11-6	
Echo Back (Rear USB port)		11-7	
Port (Rear USB port)		11-7	
Transceive.....		11-6	
Cleaning		12-1	
Clock			
NTP Function		11-10	
NTP Server address.....		11-10	
NTP Server address setting		10-1	
NTP TIME.....		11-10	
NTP Time Server.....		10-1	
Setting date and time		10-1	
Time Set		11-10	
Time synchronization		10-1	
UTC Offset		11-10	
Clone Mode		11-10	
COM ID (Common ID).....		5-10	
CONNECTOR INFORMATION		16-1	
Connectors		11-5	
Control Port (UDP) (Valid after Restart)		11-8	
Copying the Memory contents.....		8-3	
CW			
CW		5-5	
Normal Side		11-3	
Reversing the carrier point.....		5-5	
	D		
Daily timer.....		10-2	
Date.....		11-4, 11-10	
DC power supply		2-1	
Decoding FSK signal.....		5-5	
Decryption function.....		5-10	
De-Emphasis.....		11-2	
Default Gateway (Valid after Restart)		11-7	
Descrambler function.....		5-10	
DHCP (Valid after Restart)		11-7	
DIAL A.....		1-2	
DIAL B		1-1	
DIAL C		1-2	
Dial Lock function		3-3	
Dial/Panel Lock function.....		3-3	
Digital Code Squelch.....		5-9	
Digital IF filter.....		5-3	
Digital Mode Select.....		11-4	
Digital Monitor.....		11-4	
Digital Set		11-4	
Digital Squelch.....		5-9	
Digital Twin PBT		5-2	
Directly entering a frequency.....		3-2	
Display Type		11-9	

INDEX

- DISPOSAL..... iii
Downloading the firmware file 13-1
dPMR..... 5-10
D.SQ (Digital Squelch) function 5-9
D-STAR Auto Detect..... 11-4
D-STAR Data Baud Rate..... 11-5, 11-6
D-STAR EMR AF Level 11-4
D-STAR Standby Beep..... 11-4
DTCS codes 5-9
Duplex operation 5-4
- E**
- Entering a frequency 3-2
Entering a group/memory name 8-4
Entering a group name 8-4
Entering a memory name 8-4
Entering and editing characters..... 1-7
Entering the Set mode..... 11-1
Entry example (Group and memory name) 1-8
External device connection..... 2-3
External Meter Level..... 11-7
External Meter Output 11-7
- F**
- FCC INFORMATION iii
FEATURES..... ii
FFT scope zone..... 4-3
Fine Δ F scan operation 9-5
Fine Programmed scan 9-4
Fine Programmed scan operation 9-4
Fine tuning..... 3-4
Firmware
 Download URL 13-1
 Updating..... 13-2
 Version 11-10
 Version checking 13-1
 Unzipping the firmware folder 13-1
Fixed mode screen 4-1
Formatting an SD card 7-2
Frequency coverage..... 14-1
Front panel 1-1
FSK (RTTY)
 Decode..... 5-5
 Decoder..... 2-2
 Decode Baud Rate..... 11-5, 11-6
 DECODE SET screen 5-8
 Decode setting 5-8
 Logging 5-6
 Log view..... 5-7
 Receiving FSK (RTTY) signal 5-5
 Shift setting 5-7
 Tone and shift setting 5-7
FUNCTION KEY 1-1
FUNCTION screen 1-7, 5-1, 5-6
Function menu keys 4-1
- Fuse
 Circuitry fuse 12-1
 DC power cable fuses 12-1
 Replacement 12-1
- G**
- Grounding..... 2-1
Group Code (COM ID) and CC 5-10
Group Name Popup..... 11-9
- H**
- Headphones 2-3
Heat dissipation 2-1
History log..... 5-11
HPF/LPF 11-2
- I**
- IF
 IF filter 5-3
 IF filter passband widths 5-3
 IF filter shape 5-3
 IF Output Level..... 11-5, 11-6
 Digital IF filter 5-3
 Twin Peak Filter..... 5-7
 Using the Digital Twin PBT..... 5-2
IMPORTANT i
Inserting a blank channel..... 8-3
Inserting or removing the SD card..... 7-1
Interfere prevention 2-1
Internet Access Line 11-8
IP Address (Valid after Restart) 11-7
IP Plus function..... 5-2
- K**
- Keyboard
 Entering and editing 1-7
 Full Keyboard 1-8
 Keyboard Type 11-4
 Tenkey 1-8
- L**
- Language
 Display Language 11-9
 System Language 11-9
LAN port 2-3
LCD Backlight..... 11-9
LED Bright 11-9
Loading the setting data 7-3
Load setting..... 11-10

M

MAIN DIAL..... 1-1

MAIN DIAL Auto TS..... 11-3

MB-123 (Optional) attachment 15-1

Memory channel

 Entry example (Group and memory name)..... 1-8

 Inserting a blank channel 8-3

 Memory channels..... 8-1

 Memory channel clearing 8-3

 Memory channel group name 8-4

 Memory channel group select screen 8-1

 Memory channel group selecting 8-1

 Memory channel name..... 8-4

 Memory channel tree view 8-1

 Memory contents copying 8-3

 Memory Name..... 11-9

 MEMORY screen 8-5

 Selecting a memory channel..... 8-2

 Selecting channel group..... 8-1

 Writing a memory channel 8-2

MENU KEY..... 1-1

MENU screen 1-6

Meter

 Meter display types 3-4

 Meter Peak Hold 11-9

Mini scope screen..... 4-3

MN-Q Popup..... 11-9

Mode select memory scan..... 9-9

MODE SPEECH 11-2

Monitor function 3-1

Monitoring the Priority channel..... 9-2

MULTI DIAL MENU..... 1-6

N

NAC 5-9

Network

 2nd DNS Server 11-7

 Audio Port (UDP) 11-8

 Control Port (UDP)..... 11-8

 Default Gateway..... 11-7

 Internet Access Line..... 11-8

 IP Address..... 11-7

 LAN port..... 2-3

 Network Access Code (NAC)..... 5-9

 Network Control 11-8

 Network Name 11-8

 Network Radio Name 11-8

 Network User Administrator 11-8

 Network User ID..... 11-8

 Network User Password..... 11-8

 Primary DNS Server..... 11-7

 Serial Port (UDP) 11-8

 Subnet Mask 11-7

 Transceive Address..... 11-6

Noise Blanker (NB)..... 5-4

Noise reduction..... 5-4

Normal recording 6-1

Notch Filter 5-2

Notching width and frequency 5-2

NTP Function..... 11-10

NTP Server Address..... 11-10

NTP TIME 11-10

NTP Time Server 10-1

O

Opening Comment 11-9

Opening Message 11-9

Options 15-1

Output Select..... 11-5, 11-6

P

P25 5-9

P25 RX ID Display..... 11-9

Panel Lock function 3-3

Partial reset 11-10, 12-2

Peak signal 4-3

Phones Level Ratio 11-5

Playback screen 6-2

PLAYER SET screen..... 6-4

Playing back 6-1

Power consumption 14-1

Power OFF Setting (for Remote Control) 11-8

Power supply 2-1

Power supply requirement..... 14-1

Preamplifier 5-1

PRECAUTIONS..... viii

Primary DNS Server (Valid after Restart)..... 11-7

Priority scan

 About the Priority scan 9-1

 Monitoring the Priority channel..... 9-2

 Priority interval 9-2

 Priority scan operation 9-2

 Programmable Tuning Step function..... 3-3

Programmed scan 9-4

Q

QUICK MENU..... 1-6

Quick recording 6-1

R

Radio Access Number (RAN)..... 5-10

Rear panel 1-3

Receive frequency..... 3-2

Receive history log 5-11

Receiving mode..... 3-1

Receiving modes 14-1

Recording

 Normal recording..... 6-1

 Operation while playing back 6-2

 Playback screen..... 6-2

 PLAYER SET screen..... 6-4

INDEX

Playing back.....	6-1
Playing back on a PC.....	6-2
Quick recording.....	6-1
Recording setting.....	6-1
RECORDER SET screen.....	6-4
REF (reference frequency) adjust.....	11-4
Reference level.....	4-4
REF IN/OUT.....	11-7
Reset	
All reset.....	11-10, 12-2
Partial reset.....	11-10, 12-2
Reversing the carrier point.....	5-5
RF gain.....	3-1
RX history items.....	5-11
RX History Log.....	11-4
RX Marker.....	4-1
RX Popup.....	11-9
RX Record (D-STAR RPT).....	11-4

S

Save Setting.....	11-10
Saving data onto the SD card.....	7-1
Saving in the old format.....	7-2
Saving the setting data.....	7-2
Scan pause timer.....	9-2
Scan	
Δ F scan.....	9-5
Basic scanning.....	9-1
Fine Δ F scan operation.....	9-5
Fine Programmed scan.....	9-4
Fine Programmed scan operation.....	9-4
Memory scan and Select Memory scan.....	9-7
Memory scan operation.....	9-7
Mode select memory scan.....	9-9
Scan Resume function.....	9-2
Scan pause timer.....	9-2
Scan Setting screen.....	9-3
SCAN SPEECH (at Receive Pause).....	11-2
Scan speed.....	9-1
Scan types.....	9-1
Select Memory channel.....	9-7
Select Memory channel settings.....	9-8
Select Memory channel clearing.....	9-8
Select Memory channel setting.....	9-8
Skip frequency.....	9-9
Temporary Skip.....	9-10
Tone scan operation.....	9-11
Programmed scan.....	9-4
VFO scan and Memory scan.....	9-1
Spectrum scope	
Center mode screen.....	4-1
Reference level.....	4-4
Scope screen.....	4-1
Scope screen parameters.....	4-5
Scope set screen.....	4-5
Waterfall zone.....	4-3

Screen	
Screen Capture File Type.....	11-4
Screen Capture function.....	5-11
Screen Capture [POWER] Switch.....	11-3
Screen Capture View.....	11-10
Screen Saver.....	11-9
Touch screen calibration.....	12-3
SD card.....	11-10
Audio file delete.....	6-3
Audio file folder delete.....	6-4
Audio file information.....	6-3
Checking SD card information.....	7-3
Checking the file information.....	6-3
Formatting an SD card.....	7-2
Inserting or removing.....	7-1
Loading the data files.....	7-3
SD card compatibility.....	7-1
SD card data.....	7-1
SD card deleting a data file.....	7-3
SD card deleting a folder.....	6-4
SD Card Info.....	11-10
SD card information.....	7-3
SD card loading data files.....	7-3
SD card removal.....	7-1
SD card saving setting data.....	7-2
SD card's folder contents.....	7-1
Saving data onto the SD card.....	7-1
Saving in the old format.....	7-2
Saving the setting data.....	7-2
Searching for the peak signal.....	4-3
Search menu keys.....	4-3
Select Memory channel.....	9-7
Select Memory channel clearing.....	9-8
Select Memory channel setting.....	9-8
Select Memory scan operation.....	9-7
Sensitivity.....	14-1
Separator/Decimal.....	11-4
Serial Function.....	11-5, 11-6
Serial Port (UDP) (Valid after Restart).....	11-8
Set mode description.....	11-1
Setting time.....	10-1
Skip channel for memory scan.....	9-10
Skip frequency.....	9-9
Sleep timer.....	10-2
S-Level SPEECH.....	11-2
Specification.....	14-1
Spectrum Scope	
Fixed mode screen.....	4-1
Mini scope screen.....	4-3
Peak signal.....	4-3
Range.....	4-2
Span.....	4-2
Spectrum scope screen.....	4-1
Sweep speed.....	4-4

Speech function
 Language 11-2
 Level..... 11-3
 SPEECH Output for Ext connectors..... 11-3
 SPEECH Output for Recording 11-3
 SPEECH Speed 11-2
 SQL level3-1
 SSB/CW Synchronous Tuning..... 11-3
 S (Synchronous)-AM mode3-2
 Stand2-1
 Subnet Mask..... 11-7
 Supplied accessories..... ii
 Sweep speed.....4-4
 System Language..... 11-9

T

TABLE OF CONTENTS..... v
 Temporary Skip.....9-10
 Time..... 11-10
 Time and Date 10-1
 Timer 10-2
 Daily timer 10-2
 Sleep timer 10-2
 Timer accuracy..... 10-2
 Timer recording 10-3
 Timer setting items 10-3
 Time Set 11-10
 Tone Control 11-2
 Tone frequencies5-9
 Tone scan operation 9-11
 Tone squelch function.....5-9
 Touch panel display 1-4
 Touch screen calibration..... 11-10, 12-3
 Touch screen operation4-3
 TRADEMARKS..... i
 Treble 11-2
 Troubleshooting..... 12-4
 Tuning indicator3-4
 Tuning Step3-2
 Changing the Tuning Step.....3-2
 Tuning Step (TS) function3-2
 Twin Peak Filter5-7

U

Unmount..... 11-10
 Unzipping the firmware folder..... 13-1
 USB/LAN→REMOTE Transceive Address..... 11-6
 Using the Digital Twin PBT5-2
 Using the Spectrum Scope.....4-1
 UTC Offset..... 11-10

V

Version..... 11-10
 VFO and Memory modes3-1
 VFO scan and Memory scan9-1
 Viewing the captured screen 5-11
 Voice Squelch Control function..... 9-11
 Volume level3-1

W

Waterfall zone.....4-3
 Writing a memory channel.....8-2

Count on us!

