



ZASTONE ELECTRONICS CO LIMITED

UV008

**DUAL BAND DIGITAL
TWO-WAY RADIO**



USER MANUAL



THANK YOU!

We are grateful that you chose our radio for your land mobile radio applications.

We believe this easy-to-use digital dual band radio will provide dependable and reliable communication to personal operating at peak efficiency. The radio incorporates the latest in advanced technology. As a result, we feel strongly that you will be pleased with the quality and features of this product!

CONTENT

UNPACKING AND CHECKING EQUIPMENT	01
Packing Lists	01
PREPARATION	02~06
Charging the Battery Pack	02
LED Indicator	03
Attaching/Removing the Antenna	04
Installing/Removing the Battery Pack	05
Installing the Belt Clip	06
Installing the Earphone	06
GETTING ACQUAINTED	07~11
Orientation	07
Programmable Auxiliary Functions	08
LCD Icons	10
LED Indicator	11
BASIC OPERATION	12~13
MENU	14~19
FUNCTION OPERATIONS	20~29
CTCSS/DCS	30
TROUBLESHOOTING	31~33

UNPACKING AND CHECKING EQUIPMENT

Carefully unpack the transceiver. We recommend that you identify the items listed in the following table before discarding the packing material. If any items are missing or have been damaged during shipment, file a claim with the carrier immediately.

Packing Lists

Description	Quantity
Radio	1
Battery Pack	1
Desktop Stand	1
Adapter	1
Antenna	1
Belt Clip	1
Handstrap	1
User Manual	1

PREPARATION

Charging the Battery Pack

1. Using the Battery Pack.

The battery pack is not charged at the factory, please charge it before use. To extend the battery pack lifetime, please power off the transceiver and remove the battery pack when not in use.

2. Battery Pack Characteristics.

The battery will slowly wear out even not in use. After charging and recharging, it's normal that the talk and standby times are noticeably shorter than normal times. If leaving the battery in very hot or cold place, it will reduce the capacity and lifetime of the battery. Overcharging may also shorten its lifetime.

3. Charging the Battery Pack.

Please charge your battery only with approved charger.

Initially charging the battery pack after purchase or extended storage (greater than 2 months) will not bring the battery pack to its normal operating capacity. After repeating the charge/discharge cycle two or three times, the operating capacity will increase to normal level.

PREPARATION

Please charge the battery pack as follows:

1. Slide the battery pack or transceiver with a battery pack into the desktop charger.
2. Make sure the battery pack contacts are in contact with the charging terminals.
3. The charging LED lights red and charging begins.
4. After charging about 4 hours, when the light turns to green, it means the battery pack is fully charged.
5. Then you can take off the battery pack or transceiver with the battery pack and use it.

LED Indicator

LED Indicator	Status
The LED glows red.	Charging the battery pack.
The LED flashes between red and green.	Already charge the battery is charged up to 90%.
The LED flashes red.	The battery pack is short circuit or low voltage status.
The LED glows green.	Charging completed.

PREPARATION

Attaching/Removing the Antenna

1. Screw the antenna into the connector on the top of the transceiver by holding the antenna at its base and turning it clockwise until secure.
2. Turn the antenna counter clockwise until you can remove it.

Installing/Removing the Battery Pack

To install the battery pack, Fit the extensions at the bottom of the battery into the slots at the bottom of the transceiver's body. Press the top part of the battery towards the transceiver until a "click" sound is heard.

To remove the battery pack, lift up the battery latches in the middle of the battery. Pull the top part of the battery away from the transceiver's body, and lift the battery from the transceiver's body.

Installing the Belt Clip

If necessary, screw the belt clip at the back of the battery.

Installing the Earphone

Insert the earphone plug into the speaker/microphone jacks.

GETTING ACQUAINTED

Orientation

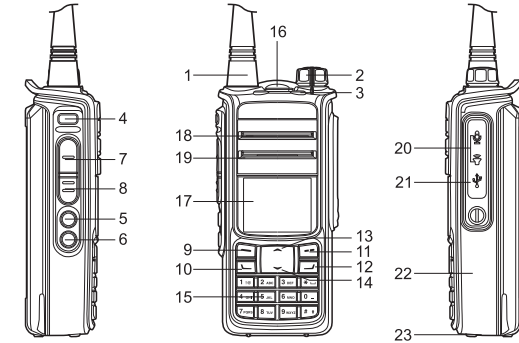

No.	Part Name	No.	Part Name
1	Antenna	13	UP Key
2	Power/Volume Switch	14	Down Key
3	LED Indicator	15	Keypad
4	Top Key (TK)	16	Hand Strap Hook
5	Programming SK1	17	LCD Display
6	Programming SK2	18	Speaker
7	PTT A Key	19	Internal Microphone
8	PTT B Key	20	Earphone/Data Cable Jack
9	Menu Key	21	Micro USB
10	Contact Key	22	Battery Pack
11	Exit Key	23	Battery Lock Button
12	MR/CH/VFO Key		

GETTING ACQUAINTED

Programmable Auxiliary Functions

Your dealer may program the [TK], [SK1] or [SK2] (long press or short press) with one of the following auxiliary functions respectively.

Shortcut key	Function
None	No function.
Emergency On	Allows the user to set up an emergency call.
Emergency Off	Allows the user to terminate an outgoing emergency call.
Squelch On Momentary	To always unmute the speaker no matter whether carrier is present or not.
Zone Up	To increase the Zone number.
Zone Down	To decrease the Zone number.
Scan	Allows the user to toggle the scan feature between on or off.
Noise Ch Del	Allows the user to temporarily remove an unwanted channel from the scan list, except the selected channel. The nuisance deleted channel will be restored into the scan list, for instance, when radio is powered off and back on again.
Adjust Power Level	Quickly switch between high power and low power.
Adjust Squelch Level	Allows the user to access Squelch Level setting list.
Home Channel	When the activity in other channels or interface, press to quickly switch to the set waiting channel.

GETTING ACQUAINTED











Shortcut key	Function
Squelch On	To always unmute the speaker no matter whether carrier is present or not.
Monitor	Enable monitor function.
Talk Around	To directly communicate with other radios.
Quick Cll 1	To make corresponding service.
Quick Cll 2	To make corresponding service.
Quick Cll 3	To make corresponding service.
Quick Cll 4	To make corresponding service.
Quick Cll 5	To make corresponding service.
Lone Work	Working alone to open the key. Press this button to turn on or off individual job functions.
VOX	Hands-free transmission.
FM Radio	To activate the FM radio.

Note:

- ◆ You can set the time of pressing long key from 1.5~5.0 seconds (default: 2.0 seconds) with programming software, when you press any of [TK], [SK1] or [SK2] key, the time of pressing is over your setting time, then it's a long time key, otherwise, it's a short key.
- ◆ Squelch Off feature only to be enabled for analogue channels.

GETTING ACQUAINTED

LCD Icons

Indicator	Icon	Radio Status
RSSI		More bars indicate better signal strength.
Battery Strength Icon		More bars indicate more battery power.
Scan Icon		Scanning is in progress.
		Scanning pauses on a non-priority channel.
		Scanning pauses on Priority Channel 1.
Talk Around Icon	DM	Direct mode.
	RM	Talk around feature is activated.
Emergency Icon		The Emergency mode (other than secret emergency) is activated.
TX Power Icon	L	Low Tx power for the current channel.
	H	High Tx power for the current channel.
Receiving Icon		Receiving is in progress.
Message Icon		New message/unread message.
Channel Type	A	Analog channel.
	D	Digital channel.
	M	Mixed channel.
FM Radio	FM	Turn on the FM radio.
VFO Channel	VFO	In the VFO mode.
GPS 1		GPS is positioned.
GPS 2		No GPS signal.

GETTING ACQUAINTED

LED Indicator

The top LED indicator will help you easily identify the current radio status.

LED Indication	Radio status
LED glows red	Transmitting
LED flashes red	Low battery
LED glows green	Receiving
LED flashes orange	Scanning
LED glows orange	Within the call holding time

BASIC OPERATION

Switch Power On/Off

1. Power ON: rotate the [**Power On-Off/Volume Control**] knob clockwise until a click is heard.
2. Power OFF: rotate the [**Power On-Off/Volume Control**] knob counter-clockwise until a click is heard.

Adjusting the Volume

After turning the radio on, rotate the [**Power On-Off/Volume Control**] knob clockwise to increase the output sound volume, or counter-clockwise to decrease it.

Select Working Band

In standby mode, you can press [Toggle] key to select working band, the highlighten area on LCD display means the current working band you are selecting, the grey area on LCD display means you don't select. The PTT operation, programmable keys, keypad, tuning control ect. only work under working band.

Select Channel Mode

In standby mode, you can press [VFO/MR/CH] key to select one of VFO/MR/CH mode cyclically.

- VFO mode: You can change frequency through keypad or tuning control.
- MR mode: To display current channel information.
- CH mode: To display alias of current channel, this alias can be edited by user.

BASIC OPERATION

Selecting a Zone

A zone is a group of channels exhibiting the same property, and is programmed by your dealer. The radio supports 100 zones, each with a maximum of 200 channels. You may select a zone through any of the following method:

- 1) Go to the menu "Zone", and use the Up/Down key to select your desired zone.
- 2) You can select through the zone programmable key.

Selecting a Channel

You can use [▲]/[▼] to select the desired channel.

Battery Save

The battery save function decreases the amount of power used when signal is not being received and no operations are being performed (no keys are being pressed and no switches are being turned); While the channel is not busy and no operation is performed, battery save function activates. When a signal is received or an operation is performed, battery save is disabled.

Low Battery Alert

For extra convenience, if the battery level runs low, when press PTT to transmit, the transceiver will sounds "Please charge the battery" at setting time (every 1~255 seconds, default: OFF), to alert the user to recharge the battery.

Press the Menu Key to access menu items. Menu options are variety according to the channel which is in use. You may request your dealer to program whether some menu options will be listed.

Public Menu

Scan

Press the Menu key in the home screen and then select "Scan".

The Scan feature allows you to listen to communication activities on other channels so that you can keep a close track of your team members. This option is used to enable or disable the function.

Settings

To access this menu, press the Menu key in the home screen and then select "Setting" to "Radio Set".

- 1) The volume level: There are 3 levels (High, Mid, Low) for selection, you can select proper level based on your condition and habit.
- 2) Alert Tone: This option allows you to configure whether to emit an alert tone when making keypad operation/power on or power off tone.
- 3) Brightness: Allow the user to adjust the brightness level of the radio display.
- 4) Backlight: This option is used to enable or disable the backlight feature. There offers 6 options: Off/Infinite/5s/15s/30s/60s.

- 5) Zone: The radio supports up to 100 zones. You can use this menu to select your desired zone and you may request your dealer to program zone number or alias.
- 6) Power Level: This option allows you to set transmit power level. Alternatively, you can change the power level by pressing the shortcut key for Adjust Power Level in the home screen.
 - **H** icon displays on LCD screen is high power;
 - **L** icon is low power. High power level enables you to communicate with farther team members.
- 7) Language: This option allows you to configure radio language. There offers 2 options: Chinese/English.
- 8) Keypad Lock: To set the lock modes and turn on/off keypad lock feature.
- 9) Hands-Free VOX: To set the voice input gain level, VOX delay time or turn on/off VOX feature.
- 10) Micphone Gain: There are 3 levels (High, Mid, Low) for selection, you can select proper level based on your condition and habit.
- 11) Channel Step: In VFO mode, to select the channel step from one of them (5.00K/6.25K/10.00K/12.50K/25.00K /50.00K/100.00K).
- 12) Time-Out Timer (TOT): To set the overtime time and alert time of TOT.
- 13) Battery Saving: To turn on/off battery saving feature.

- 14) Working Modes: To set the radio working mode at dual band (Band A & Band B), only Band A or only Band B.
- 15) Edit the Channel: You can edit the current channel in the list or create a new channel and edit it. New channel will automatically be added in the current channel list.
- 16) Programming Key: There are 3 programmable side key ([TK], [SK1], [SK2]) to set your desired feature.

Noted: Menu No.15 & Menu No.16 may require input password before setting, you can program the password through software, also set no password.

Radio Information

To access this item, press the Menu key in the home screen and then select "Radio Information".

With this option, you can view basic information of your radio, including model name, radio ID, serial number, firmware version, frequency range.

Digital Menu

Contact

To access this item, press the Menu key in the home screen and then select "Contact".

- 1) Contact List:

- a) View: You can view details of each contact, such as contact alias, number.
 - b) Send Message: You can edit and send a message to a Call contact in the list.
- 2) New: You can add a Call contact to the contact list. Contact number up to 8 numbers can be input.

Check DMR ID: There are up to maximum 160000 DMR ID in the list, you can check the list and the relative details, or search your desired ID to call. If someone who already in your contact list transmit a call to you, then his/her DMR ID (Call ID, Name, Address ect.) will appear on your display.

Message

To access this item, press the Menu key in the home screen and then select "Message".

- 1) New: You can create a new message and send it out or save it to draft. You can send it to a single user or to a group.
- 2) Quick Text: Users can access quick text messages stored in the host predefined. User can edit or send these text messages.
- 3) Inbox: The Inbox can save up to 16 received messages. When the Inbox is full, the earliest message will be overwritten by the latest one automatically. For each message, you can choose to perform any of these operations: Resend, Forward, Save as New, Delete.

To delete all messages in the Inbox, select "Message -> Inbox -> Delete All".

4) Outbox: The Outbox can save up to 16 sent messages. When the Outbox is full, the earliest message will be overwritten by the latest one automatically. For each message, you can choose to perform any of these operations: Resend, Forward, Detail Save as New, Delete.

To delete all messages in the Outbox, select "Message -> Outbox -> Delete All".

5) Draft: The Drafts can save up to 16 draft messages. When the Drafts are full, the earliest message will be overwritten by the latest one automatically. For each message, you can choose to perform any of these operations: Send, Save as, Delete.

To delete all messages in the Drafts, select "Message -> Drafts -> Delete All".

Call Logs

To access this item, press the Menu key in the home screen and then select "Call Logs".

The radio can save up to 16 Private Call entries in the Outgoing/Incoming/Missed list respectively. When the Outgoing/Incoming/Missed list is full, the earliest entry will be overwritten by latest one automatically.

After accessing a list and selecting an entry, you can perform any of these operations: hold down the PTT to initiate a call; add it to Contact List; or delete it.

To delete all entries in the Outgoing/Incoming/Missed list at a time, select "Call Logs -> Outgoing/Incoming/Missed -> Delete All".

Analog Menu

Squelch Level

To access this item, press the Menu key in the home screen and then select "Settings". This option allows you select an appropriate squelch level.

FUNCTION OPERATIONS

Call

This radio supports two calls: analog and digital call. Analog channel can only speak to analog channel, Digital channel can only speak to digital channel.

- In the analog channels, hold down the PTT key to transmit a call and speak to against the MIC.
- In the digital channels, hold down the PTT key to transmit a call to the call contact preset for the current channel.

It was transferred to the receiving state after release [PTT] key.

Receive

- In the analog channels, radios can be programmed CTCSS / DCS function. If you choose to these features in the current channel, you can only receive calls the same set of radio transmitted. If you choose a channel is not set above, you will receive a call that the other using the same frequency emitted.
- In the digital channel, when you must receive a matching color code or the radio receives a call ID, you can hear the call from transmitter.

Call System

Private Call

You may initiate a Private Call through any of the following methods.

- Initiating a call to the preset contact: In the home screen, hold down the PTT key to initiate a Private Call to the Private Call contact preset for the current digital channel.

FUNCTION OPERATIONS

- Initiating a call through Contact List or Call Logs

1. Go to "Contact -> Contact List", or go to "Call Logs" access the Outgoing/Incoming/Missed list.
2. Use the Up/Down key to select the Private Call contact you want to call.
3. Hold down the PTT key to initiate the Private Call.

- Initiating a call through Manual Dial: Input a Private Call number you want to call, Hold down the PTT key to initiate the Private Call.

Group Call

You may initiate a Group Call through any of the following methods.

- Initiating a call to the preset contact: In the home screen, hold down the PTT key to initiate a Group to the Group Call contact preset for the current digital channel.
- Initiate a call through Contact List: Go to "Contact->Contact List", Use the Up/Down key to select the Group Call contact you want to call, Hold down the PTT key to initiate the Group Call.
- Initiating a call through Manual Dial: Input a Group Call number you want to call, Hold down the PTT key to initiate the Group Call.

All Call

You may initiate an All Call through any of the following methods.

- Initiating a call to the preset contact: In the home screen, hold down the PTT key to initiate a Group to the Group Call contact preset for the current digital channel.

FUNCTION OPERATIONS

- Initiate a call through Contact List: Go to "Contact->Contact List", Use the Up/Down key to select the All Call contact you want to call, Hold down the PTT key to initiate the All Call.
- Initiating a call through Manual Dial: Input a All Call number you want to call, Hold down the PTT key to initiate the All Call.

Call Hang

This is unique features of digital channels.

Press [PTT], you can continue to call back after the call to end and within the call holding time. The specific time provided by the dealer.

Adjust Power Level

Power level indicates the power of the transmit power; radios can be set power level according to the actual demand. After the power level is adjusted by programming key, power is switched between high and low power.

Channel Spacing

Analog channel: 12.5K and 25K.

Digital channel: 12.5K.

TX Admit

If enabled via the programming software, this feature can prevent radio interfering with other transmitting radios on the same channel.

If you hold down the PTT key while the channel is in use, your radio

FUNCTION OPERATIONS

will keep beeping alerting you to transmission prohibition. To stop beeping, please release the PTT key. When the channel is free, you can hold down the PTT key to transmit.

RX Only

Current channel only do receive, and prohibit any transmit on the channel.

TOT

The purpose of TOT is to prevent any user from occupying a channel for an extended period. If the preset time expires, radio will automatically terminate transmission and keep beeping. To stop beeping, please release the PTT key. You must wait for a certain time period (preset by your dealer) to initiate another transmission.

Talk around

You can continue to communicate in DM mode by pressing the programmed Talk Around key, when your repeater malfunction or when your radio is out of the repeater's range but within talking range of other radios.

Private Call Confirmed

This feature sets Private Individual calls on the current digital channel as confirmed. By default, Private Individual calls are unconfirmed.

FUNCTION OPERATIONS

Squelch Tail Elimination (STE)

When finish communication, there is a tail squelch, you can use this feature to eliminate.

The default setting is OFF.

NOTE: Only analog channel have this function.

VOX

The VOX feature allows radio to transmit just need the voice rather than press the PTT.

Adjust Squelch Level

When there is no signal present, squelch outputs muffler from background noise (squelch circuit closed).

You can choose to squelch level.

Squelch On

Press programmed to squelch on button, radios will sound background noise, again press the button to exit.

Squelch On Momentary

With the same to squelch on function, only difference is you need to hold down to work, when you release the squelch is closed.

Scan

Scan feature can help you listen to the other channels of communication activities. The scanning process is as follows:

FUNCTION OPERATIONS

1. When scanned, LED flashes orange.
2. When you scan a channel that has an active, the radio will remain in the current channel.
3. In the scanning process can be transmit, transmitting mode configured by the dealer.
4. Press the Scan button to exit.

Note: When scanning, the VOX function does not work.

Digital Emergency

In case of an emergency, you can seek through this function to a partner or a control center to help. Start the alarm function can be activated by the emergency alarm button.

This radio supports 3 kinds of emergency mode, you can choose one of the following:

1. Emergency: The radio sends an emergency alarm and exits the emergency mode. This alarm is non-voice signal that triggers an alert indication on another radio.
2. Emergency Call: An emergency alarm is sent, after which an emergency call can be transmitted by pressing the PTT button.
3. Urgent Call: This option enables the Hot Mic feature, allowing for the programming of the Hot Mic related feature, i.e. Hot Mic Duration. An emergency alarm is sent and the microphone is activated for an urgent call. Voice is transmitted without the need to press the PTT button.

FUNCTION OPERATIONS

Lone Worker

If radio has no valid physical operations (buttons) within a range of time, during which time the pre-alarm tone will sound, the time it reaches the set value, is recognized as an emergency, entered an emergency alarm mode.

Quick Call

Quick call access feature allows you to operate according to the preset key setting function, this function can be set through the radio side key function.

Digital: To initiate a call to send Short Message/Call Alert/Radio Check/Remote Monitoring to the specified contact.

Encrypt

This is unique features of digital channels. Encrypt feature can encrypt your audio signals to prevent eavesdropping, thus privacy of your communication is guaranteed.

Radio Disable

Sometime you would like the radio is prohibited to transmit and receive, then you can use remote disable function.

Radio Enable

It wakes the radio in the Disable state.

FUNCTION OPERATIONS

Remote Monitor

Remote monitoring function is allowing users to remotely activate the microphone of the target radio, the target radio secretly send background voice to users, so as to achieve the effect to voice messages be monitored.

Radio Check

Radio Check allows you to configure whether the target radio can send an acknowledgement back to the digital channel. Radio Check enables the originating radio to recognize that a call using the digital channel has been received by the target transceiver. NOTE: Only private call has this function.

Keypad Lockout

Press [Menu] key and [*] key in 2 seconds after pressing [Menu] key to lock the keypad.

When keypad lockout, press [Menu] key and press [*] key in 2 seconds after pressing [Menu] key to unlock the keypad.

There are 2 modes of keypad lockout:

Keypad: Only lockout of keypad.

ALL: Lockout of all keypad, button and switch except [PTT] button.

Digital Monitor

You can turn on/off this feature through "Setting" - "Digital Monitor"

FUNCTION OPERATIONS

menu in menu system. When turn on this feature, your radio will monitor current channel and show out the relative infos (DMR ID, color code) on "Channel Infos" menu. You can set only to monitor the channel of the same ID or anyone of ID, the same color code or anyone of color code in your list, when select anyone of ID or color code, it means to monitor all digital channel call.

Transmit Interrupt

This feature allows you to stop an ongoing transmission of a remote interruptible call to free the channel.

Voice Interrupt: When your radio is receiving an interruptible call, you can stop the call at any time, just press and hold your [PTT] button to transmit the order of interruption, when end the interruption of the call, you can transmit your call. This feature is only operated for digital channel and should select "transmit interrupt" of channel setting in advance.

Digital & Analog Converter

When the current channel is in mix mode, your radio can receive the signals of both of digital call or analogue call. In this mode, the setting of analogue receiving should be set with CTCSS.

FUNCTION OPERATIONS

GPS

If you buy this radio version with GPS feature and turn it on, " 📍 " will be appeared on LCD display, if " 📍 " to be appeared, it means successfully position and the relative coordinates info will be appeared.

(Note: please use GPS feature in open area.)

FM Radio

You can turn on/off FM radio through programmable key or menu of "setting" - "FM Radio".

There are 20 memory channels and 1 VFO channel, you can toggle the VFO and MR mode through [VFO/MR/CH] key. Memory channels only to be programmed through software in advance.

1. In MR mode, no any frequency to be showed on LCD display means idle channel, you can input the frequency to automatically save to current channel, then press [▲]/[▼] key or tuning control to select MR channel.
2. In VFO mode, you can input frequency directly, or when turn on FM radio, use [▲]/[▼] key to scan the frequency. When scanning to a valid frequency, it will stay on the current channel.

Standard CTCSS Tones Table

1 - 67.0	11 - 94.8	21 - 131.8	31 - 171.3	41 - 203.5
2 - 69.3	12 - 97.4	22 - 136.5	32 - 173.8	42 - 206.5
3 - 71.9	13 - 100.0	23 - 141.3	33 - 177.3	43 - 210.7
4 - 74.4	14 - 103.5	24 - 146.2	34 - 179.9	44 - 218.1
5 - 77.0	15 - 107.2	25 - 151.4	35 - 183.5	45 - 225.7
6 - 79.7	16 - 110.9	26 - 156.7	36 - 186.2	46 - 229.1
7 - 82.5	17 - 114.8	27 - 159.8	37 - 189.9	47 - 233.6
8 - 85.4	18 - 118.8	28 - 162.2	38 - 192.8	48 - 241.8
9 - 88.5	19 - 123.0	29 - 165.5	39 - 196.6	49 - 250.3
10 - 91.5	20 - 127.3	30 - 167.9	40 - 199.5	50 - 254.1

Standard DCS Codes Table

023	071	143	225	266	356	452	532	664
025	072	145	226	271	364	454	546	703
026	073	152	243	274	365	455	565	712
031	074	155	244	306	371	462	606	723
032	114	156	245	311	411	464	612	731
036	115	162	246	315	412	465	624	732
043	116	165	251	325	413	466	627	734
047	122	172	252	331	423	503	631	743
051	125	174	255	332	431	506	632	754
053	131	205	261	343	432	516	645	
054	132	212	263	346	445	523	654	
065	134	223	265	351	446	526	662	

Phenomena	Analysis	Solution
Power-on Failure.	<ul style="list-style-type: none"> The battery may be improperly installed. 	Remove the battery and reassemble it.
	<ul style="list-style-type: none"> The battery may be dead. 	Recharge or replace the battery.
	<ul style="list-style-type: none"> The battery is poorly connected due to dirtied or damaged battery contacts. 	Clean the battery contacts. If the problem cannot be solved, contact your dealer or authorized service center for inspection and repair.
During receiving, the voice is weak, discontinuous or totally inactive.	<ul style="list-style-type: none"> Low battery voltage. 	Recharge or replace the battery.
	<ul style="list-style-type: none"> Low volume level. 	Increase the volume by rotating the Volume Control knob.
	<ul style="list-style-type: none"> The antenna may be loosened or improperly installed. 	Reassemble the antenna after turning off the radio.
	<ul style="list-style-type: none"> The speaker may be blocked or damaged. 	Clean the surface of the speaker. If the problem cannot be solved, contact your dealer or authorized service center for inspection and repair.

TROUBLESHOOTING

Phenomena	Analysis	Solution
Unable to communicate with other members.	<ul style="list-style-type: none"> The frequency or signaling may be inconsistent with that of other members. 	Set your TX/RX frequency and signaling to the same as that of other members.
	<ul style="list-style-type: none"> The channel type (digital/analogue) may be set inconsistently. 	Make sure all members are on the same digital/analogue channel.
	<ul style="list-style-type: none"> You may be too far away from the group members. 	Move towards other members.
Irrelevant communication or noise is heard on the channel.	<ul style="list-style-type: none"> You may be interrupted by radios using the same frequency. 	Change the frequency, or adjust the squelch level.
	<ul style="list-style-type: none"> The radio may be set with no signaling. 	Set signaling for all member radios to avoid interference at the same frequency. And change the signaling settings for all portable radios at the same time.

TROUBLESHOOTING

Phenomena	Analysis	Solution
The noise is too loud.	<ul style="list-style-type: none"> You may be too far away from other members. 	Move towards other members.
	<ul style="list-style-type: none"> You may locate in an unfavorable position. For example, your communication may be blocked by high buildings or frustrated in the underground areas. 	Move to an open and flat area, and restart the radio to try again.
	<ul style="list-style-type: none"> You may suffer from external disturbance (such as electromagnetic interference). 	Stay away from equipment that may cause interference.

省信息化局(省无线电管理办公室)友情提醒

购买、使用本设备属于设置使用无线电台(站)的行为,必须依法办理设台审批手续,领取无线电台执照。在使用设备过程中,应当按照电台执照核定的项目工作。擅自设置使用无线电台(站)、干扰无线电业务、不按核定项目工作以及其他违反无线电管理法规的行为,由无线电管理机构给予行政处罚。严重的无线电违法行为,还可能触犯《刑法》第288条或《治安管理处罚法》第28条,将被处以三年以下有期徒刑、拘役或者管制,并处或者单处罚金的刑事处罚或者由公安机关处以拘留的行政处罚。

致尊敬的用户

非常感谢您使用本品牌无线对讲机。我们相信这台易于使用的双段数字无线对讲机将给您带来可靠、清晰、高效的无线通讯服务,让您的工作保持高效率。为了让您充分地了解该对讲机的各种优越性能及使用、保养方法,请仔细阅读此说明书。

开箱和配置检查	01
准备工作	02
对电池组进行充电	02
安装/卸下天线	03
安装/卸下电池组	03
安装皮带夹	03
安装另购的音频附件/编程线	03
熟悉对讲机	04
可编程键设置	05
LED指示灯	06
LCD状态图标	07
基本操作	08
菜单设置	11
高级操作	17
附表一、CTCSS模拟亚音频表 (Hz)	28
附表二、DCS数字亚音代码表	28
常见故障处理指南	29
清洁与保养	30

包装盒内含有以下物件，如有任何丢失或损坏，请与您所购产品的经销商联系。

包装清单

配件名称	数量
对讲机	1
锂离子电池组	1
充电座	1
电源适配器	1
橡胶天线	1
皮带夹	1
手提绳	1
用户手册	1

对电池组进行充电

请使用本公司指定的充电座对电池进行充电，充电座的指示灯可显示充电状态。

充电请按如下步骤进行操作：

1. 将充电座的直流插头连接至交流电源线插座；
2. 充电指示灯亮橙色约2秒后熄灭；
3. 将电池组或装有电池组的对讲机插入充电座上；
4. 确认电池组与充电座端子接触好，充电指示灯变为红色，充电开始；
5. 当充电指示灯变为绿色时，表示充电完成，此时，可以取走电池组或装有电池组的对讲机使用。

**注意：**

装有电池组的对讲机请关闭电源后进行充电，否则会影响正常的充电过程。同时，充电期间请勿使用对讲机。

充电指示灯

指示灯显示	状态
红灯亮	正在充电
红绿灯交替闪烁	电池充电容量大于90%，转入慢充
红灯闪亮	电池短路现象或电池低压现象
绿灯亮	已充电完成

安装/卸下天线

1. 沿顺时针方向旋转天线直至旋紧。
2. 如需卸下天线，逆时针旋转即可。

安装/卸下电池组

1. 安装电池组时，将电池组对准对讲机相应位置，然后将电池组向下轻按，直到听见“咔嗒”声响起。
2. 卸下电池组时，请先确认对讲机已关闭，然后将对讲机的电池扣向上轻推，听到“嚓”的一声，电池将向上弹起，将电池组取下。

安装皮带夹

1. 如有必要，可将皮带夹锁入机身背面的螺丝孔。
2. 要卸下皮带夹时，只须将两个螺丝旋下即可。

安装另购的音频附件/编程线

掀开附件口盖，将附件直接插入耳机插孔即可。

部件介绍

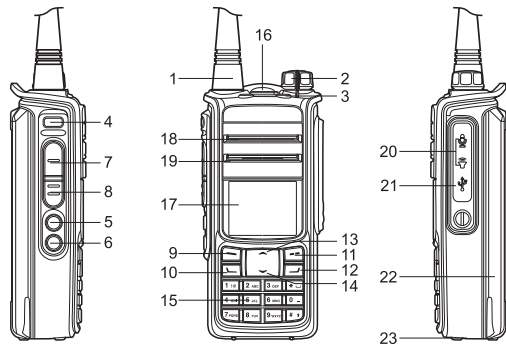

序号	部件名称	序号	部件名称
1	天线	13	向上按键
2	电源开关/音量控制	14	向下按键
3	状态指示灯	15	数字键盘
4	可编程键(TK)	16	手提绳孔
5	可编程键(SK1)	17	彩色显示屏
6	可编程键(SK1)	18	喇叭
7	发射键(PTT A)	19	麦克风
8	发射键(PTT B)	20	音频附件/编程线插孔
9	菜单键	21	USB插孔
10	进入联系人	22	电池组
11	返回键/A/B键	23	电池卡扣
12	MR/CH/VFO键		

可编程键设置

经销商可根据客户需求，通过写频软件将[TK]/[SK1]/[SK2]长按或短按编程设置为下列功能之一。参阅“高级操作”部分的说明。

序号	可编程项目	用途
1	无功能	该功能键不设置任何功能
2	报警开启	启动报警功能
3	报警关闭	关闭报警功能
4	暂态静噪开启	无论是否检测到载波，喇叭暂时打开
5	区域上升	区域依次递增切换
6	区域下降	区域依次递减切换
7	扫描开启	启动扫描功能
8	噪声信道临时删除	暂时删除产生不需要的噪声的信道
9	功率级别调整	快速调整发射功率
10	静噪级别调整	调整所需静噪级别
11	守候信道	当活动在其它信道或界面时，按此键可快速切换到设定的守候信道
12	静噪开启	无论是否检测到载波，喇叭始终打开
13	监听	启动监听功能
14	脱网	开启或关闭脱网功能
15	一键通1~5	只需按下一键编程按键便可发起呼叫
16	单独工作	单独工作开关键。按下该键开启或关闭单独工作功能
17	声控	不需要按PTT只用语音就能实现发射
18	收音机	快捷开启收音机应用界面

**备注:**

- 您可以通过写频软件设置长按时间(可设定时间范围: 1.5-5秒, 默认设置为: 2秒), 如果您按这些编程键时, 用时比设定的长按时间更长时, 则为长按; 比设定的长按时间短时, 则为短按。
- 同一按键的短按和长按可实现不同功能, 长按可以配置按键的时间, 具体由经销商设置。
- 监听键功能只对模拟信道起作用。

LED指示灯

顶部LED指示灯让您轻松掌握对讲机当前的操作状态。

指示灯状态	对讲机状态
红灯常亮	正在高功率发射
红灯闪烁	处于低电状态
绿灯常亮	正在接收
橙灯闪烁	正在扫描
橙灯常亮	呼叫保持时间内/低功率发射

LCD状态图标

图标名称	图标显示	对讲机状态
信号强度		信号条数越多, 信号越强
电池电量		格数越多表示当前电池电量越多
扫描		对讲机处于扫描状态
		扫描停留于非优先信道
		扫描停留于优先信道1
通信模式	DM	已开启直通模式
	RM	已开启中转模式
紧急报警		对讲机处于紧急报警状态(秘密报警除外)
功率	L	当前信道功率为低功率
	H	当前信道功率为高功率
接收		对讲机处于接收状态时, 显示信号
消息图标		接收到短信/有未读短消息
信道类型	A	模拟信道
	D	数字信道
	M	混合信道
收音机	FM	收音机处于开启状态
VFO信道	VFO	当前信道为VFO信道
GPS 1		已定位
GPS 2		未定位

呼叫

本机支持两种呼叫：模拟呼叫和数字呼叫，基于这两种呼叫实现的方式不同，模拟信道只能和模拟信道通话；数字信道只能和数字信道通话。

在模拟信道上，按住PTT键对着MIC说话就能进行呼叫。

在数字信道上，按PTT键即可对当前信道上预设的呼叫联系人发起呼叫。松开[PTT]键则转入接收状态，每个信道设置的呼叫联系人由经销商设置。为了保证接收方的最佳接收音量，发射时请保持麦克风距离嘴大约2.5至5厘米。

接收

在模拟信道上，对讲机可以编程设定CTCSS/DCS功能或信令。如果选择设定了这些功能的信道，您仅能收到与您系统CTCSS/DCS和信令相同设定的对讲机发出的呼叫。如果您选择的信道没有设定以上功能，您将接收到其他使用相同频率的对讲发出的呼叫。

在数字信道上，必须接收到匹配的色码或者接收到呼叫本机ID时，才能听到发射方的呼叫。

开机与关机

如需开机，请顺时针旋转[电源开关/音量控制]旋钮直到听到“咔嗒”声；如需关机，请逆时针旋转此旋钮直到听到“咔嗒”声。

调整音量

开机后，顺时针旋转[电源开关/音量控制]旋钮可增大音量，逆时针旋转可减小音量。

选择A/B段工作区域



您可以通过在待机界面中按[]键来进行A/B段工作区域的切换，被选中的工作区域显示为高亮，未被选中的区域显示为灰色。

选择信道模式

您可以通过在待机界面中按[]键在VFO/MR/CH三种信道模式中进行来回切换。VFO模式下，您可以通过数字键盘或向上按键对当前VFO信道的频率进行设置。MR模式下，显示当前信道频率信息。CH模式下，显示当前信道或别名信息，信道别名可由用户自行定义。

选择区域

区域是一个信道组，即您可将具有相同属性的信道列入到一个区域中，这样便于您对现有信道进行有效管理。本机共1000个信道，支持100个区域，每个区域最多包含200个信道。您可通过以下两种方式选择区域：

1. 通过菜单选择进入“区域”菜单后，按[]/[]键来选择所需区域，然后按菜单键切换至所选区域。
2. 通过编程键选择，若经销商为您设置了选择区域快捷键，则按此快捷键可切换至所需区域。

选择信道

按[**▲**]/[**▼**]键即可选择所需信道。

电池省电

当对讲机未收到信号或无操作时，持续时间大于进入省电延迟时间时，接收电路进入省电状态，省电功能启动；在接收到信号或进行操作时，电池省电功能自动关闭。

低电压提示音

当电池处于低电的状态，对讲机会每隔一段时间(具体由经销商设置)提醒用户需要充电。当电压低于禁发值时，对讲机无法发射。

按[菜单]键进入菜单，根据您正在使用的信道是数字信道还是模拟信道，可提供使用的菜单会有所不同。另外通过经销商编程设置，可以控制部分菜单是否出现。

公共菜单**扫描功能**

要进入此菜单，按[菜单]键进入主菜单后选择“扫描功能”。

扫描功能可助您收听其它信道上的通信活动，从而了解相关组员当前活动情况。您可通过[**▲**]/[**▼**]键选择扫描方向。

设置

要进入此菜单，按[菜单]键进入主菜单后选择“设置”。可对以下功能进行设置：

- 1) 通话音量：有低、中、高三级通话音量等级可选，用户可以根据使用环境及习惯来选择适当的等级；
- 2) 提示音：可设置按键音，开机或关机提示音是否开启；
- 3) 亮度：设置对讲机的背光灯亮度，有1-5个等级可选；
- 4) 背光灯：设置对讲机的背光灯，有6个选项可供选择：关闭/长亮/5s/15s/30s/60s；
- 5) 区域：本机支持100个区域，您可通过此菜单选择您所需的区域(具体区域数量、名称可由经销商通过写频软件配置)；

- 6) 功率级别: 您可在此菜单选择对讲机的发射功率级别为低、高;
- 7) 语言: 设置对讲机显示的语言, 提供中、英文两种语言选择;
- 8) 键盘锁定: 可设置键盘锁定模式及是否开启键盘锁定功能;
- 9) 声控发射: 可设置声控增益电平, 声控延迟时间, 及是否开启声控发射功能;
- 10) 麦克风增益: 有低、中、高三级麦克风增益等级可选, 用户可以根据使用环境及习惯来选择适当的等级;
- 11) 频率步进: 设置VFO信道的频率步进值, 有7个选项可供选择:
5.00K/6.25K/10.00K/12.50K/25.00K/50.00K/100.00K;
- 12) 发射限时器: 可设置超时禁发功能的超时时间及预警时间;
- 13) 省电: 可设置是否开启省电功能;
- 14) 工作模式: 可设置对讲机工作在AB双段模式或单A段、单B段模式;
- 15) 编辑信道: 可在信道列表中选取需要编辑的信道, 可对其基本参数进行编辑操作。可以新建信道并对其进行编辑操作, 新建信道将自动加入到当前工作区域(A或B)指定的信道区域中, 注: 当前信道区域中的信道数满200个时, 将不被加入;

对讲机信息

要进入此菜单, 按[菜单]键进入主菜单后选择“对讲机信息”。本机信息可助您查看本机相关信息, 如本机别名, 本机ID、机型名称、频段、固件版本。

数字菜单

联系人

要进入此菜单, 在数字信道待机界面, 按[菜单]键进入主菜单后选择“联系人”。可对以下功能进行设置:



联系人列表: 最多可存储500组联系人, 从联系人列表可进行如下操作。

- a) 查看联系人的详细信息, 如联系人别名, 号码; 若该联系人为个呼时, 可对其号码别名进行编辑。
- b) 发信息: 可对联系人列表中的联系人进行短信编辑并发送。
- c) 编辑: 联系人列表中的个呼联系人, 可对号码、别名进行编辑。
- d) 补充业务: 联系人列表中的个呼联系人可进入补充业务, 发送遥毙或激活码。
- e) 删除: 可删除新创建的个呼联系人, 但通过读写频后, 不能使用删除功能。

菜单设置

新建：此菜单可创建新联系人(仅个呼联系人)至联系人列表。输入的联系人号码最多为8位数字，不够8位时系统将自动补充为8位数。

查看DMR ID：支持最多16万个DMR ID的全网通讯录功能，您可以查看DMR ID列表及每个DMR ID的详细信息，也可以通过ID搜索功能来快速定位您想查看的ID联系人信息。可以对列表中选中的联系人按[PTT]键直接发起呼叫或在其菜单中发起呼叫提示操作。当本机接收到DMR呼叫时，如果呼入的DMR ID与此通讯录中的DMR ID相匹配，在呼入显示界面中将显示此ID的详细信息（呼号，姓名，地址等）。

短消息

要进入此菜单，在数字信道待机界面，按[菜单]键进入主菜单后选择“短消息”。可对以下功能进行编辑：



- 1) 新建：您可进入此菜单，编辑新的短消息(最多120个字符)进行发送或保存到草稿箱，可选择发送给个人或群组。
- 2) 快捷文本：用户可以选择是否可以访问存储在主机中(最多保存16条)预先定义的快捷文本信息，当用户新建信息时可以选择插入这些模板信息。

菜单设置

3) 收件箱：本机可存储最多16条已接收的短消息。若收件箱已满时收到新的短消息，最早已读的短消息将自动被覆盖，若都是未读，则覆盖最先收到的那条。您可对任一短消息进行如下操作：重发、转发、另存为新联系人、删除；要删除收件箱中的所有短消息，选择“短消息- > 收件箱- > 删除全部”。

4) 发件箱：本机可存储最多16条已发送的短消息。若发件箱已满，如有新的发送短消息，则最早的短消息将自动被覆盖。您对任一短消息进行如下操作：重发、转发、另存为新联系人、删除；要删除发件箱中的所有短消息，选择“短消息- > 收件箱- > 删除全部”。

5) 草稿箱：本机最多可存储最多16条草稿消息。当草稿已满时，如有新的草稿消息，则最早的草稿消息将自动被覆盖。您可对任一条草稿消息进行如下操作：发送、保存、删除；要删除草稿箱中的所有草稿消息，选择“短消息- > 草稿箱- > 删除全部”。

呼叫记录

要进入此菜单，在数字信道待机界面，按[菜单]键进入主菜单后选择“呼叫记录”。呼叫记录仅针对个呼。可对以下功能进行编辑：

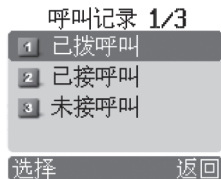

- 1) 已拨呼叫：本机可存储最多16条已拨呼叫。当呼叫记录已满时收到新的呼叫记录，将自动覆盖最早的那条记录。您可对任一记录进行呼叫、添加至联系人列表、删除等操作。
- 2) 已接呼叫：同已拨呼叫，请参考已拨呼叫。
- 3) 未接呼叫：同已拨呼叫，请参考已拨呼叫。

模拟菜单

静噪级别

在模拟信道，按菜单键进入主菜单后，选择设置-静噪级别，进入之后可以选择对讲机的静噪级别；有1~3级可选。

呼叫系统

个呼

若联系人中的呼叫类型为个呼，则实现个呼功能，个呼是由一个个体对讲机对另一个个体对讲机的呼叫。您可通过以下方式发起个呼。

对预设联系人发起呼叫：在待机界面下，按住PTT即可对当前数字信道预设的个呼联系人发起个呼。

通过“联系人列表”或“呼叫记录”发起呼叫

- a. 选择“联系人- > 联系人列表”，或进入“呼叫记录”已拨/已接/未接呼叫列表；
- b. 用[▲]/[▼]键选择您想要呼叫的个呼联系人；
- c. 按住PTT即可发起个呼。

通过手动拨号发起呼叫：在键盘上输入你想要呼叫的个呼号码，按住PTT即可发起呼叫。

组呼

若联系人中的呼叫类型为组呼，则实现组呼功能。将组呼联系人添加到组列表成员中，当接收来自该用户组的呼叫时，即可进行通话。您可以通过以下方式发起组呼。

对预设联系人发起呼叫：在待机界面下，按住PTT即可对当前数字信道上预设的组呼联系人发起组呼。

通过“联系人列表”发起呼叫：选择“联系人- >联系人列表”，用

[**▲**]/[**▼**]键选择您想要呼叫的组呼联系人，按住PTT即可发起组呼。通过手动拨号发起呼叫：在键盘上输入你想要呼叫的组呼号码，按住PTT即可发起呼叫。

全呼

若联系人中呼叫类型为全呼，则实现全呼功能，当设置全呼时此联系人将向信道所有用户发射信号。设置全呼时，需要先将写频软件设置中的允许全呼勾选。

您可以通过以下方式发起全呼。

对预设联系人发起呼叫：在待机界面下，按住PTT即可对当前数字信道上预设的组呼联系人发起全呼。

通过“联系人列表”发起呼叫：选择“联系人->联系人列表”，用[**▲**]/[**▼**]键选择您想要呼叫的全呼联系人，按住PTT即可发起全呼。通过手动拨号发起呼叫：在待机界面下，在键盘上输入全呼号，按住PTT即可发起全呼。

呼叫保持

数字信道的独特功能，个呼或组呼呼叫结束后，在呼叫保持时间内，按住[PTT]，能回拨过去继续通话。如果在呼叫保持时间外按[PTT]，则按当前数字信道绑定的联系人进行呼叫。具体保持时间由经销商设置。

功率级别调整

功率级别表示对讲机工作时发射功率的大小，对讲机可依据实际需求设置功率级别。当要求通信距离远，通话质量高的情况可选择对讲机高功率工作状态；当要求通信距离近，通话质量一般的情况可选择低功率工作状态，能减少电池的损耗，延长使用时间。按编程为功率级别调整的按键后，功率会在高、低功率之间切换，也可以通过菜单[**▲**]/[**▼**]键来选择高、低功率。

宽/窄带

模拟信道有12.5KHz和25KHz两种。

数字信道有12.5KHz一种。

准许发射条件

如果您开启了该功能，当该信道正被其它对讲机使用时，按[PTT]键无法发射，发出警告音。只有在没接收到信号时，再次按下[PTT]键才能发射，此功能可以各个信道独立设定。

允许发射：对讲机随时可以发射。

信道空闲：当所选信道繁忙时，不允许发射。

亚音匹配(模拟)：对讲机在信道空闲且亚音匹配时允许发射，否则不允许发射。

亚音不匹配(模拟)：对讲机在信道空闲且亚音不匹配时允许发射，否则不允许发射。

仅接收

表示当前信道只能做接收，禁止在该信道上进行任何发射。

超时禁发

超时禁发的作用是防止过久的占用信道，同时也防止对讲机由于长时间发射而造成损坏。如果您连续发射时间超过定时器限制的时间，对讲机将停止发射并发出禁发音。这时您需要松开[PTT]键，过一段时间(这个时间由经销商设置)后才能继续发射。

脱网

如遇中转台故障或超出中转台的覆盖范围，但两台对讲机均处于对方的通讯范围内，此时，您可按[脱网]快捷键，实现两台对讲机直接通话。

个呼确认

设置对讲机发送个呼时是否发送确认个呼请求，接收方解码确认个呼请求后自动发送回复给发射方主机，然后才能建立语音通话。

尾音消除

对讲机在加有亚音信令的信道上默认设置了此项功能，将听不到发送方由于通话结束、载波消失而引起的“嚓”音，从而使您免受噪声冲击的困扰。在没有加亚音频率的信道尾音不消除。

注：只有模拟信道才有此功能。

声控

声控发射功能可以无须按下[PTT]键，直接对着MIC说话，对讲机即可发射。

静噪级别调整

静噪功能目的在于无信号出现时，使喇叭的背景噪声输出消声(静噪电路闭路)。如果静噪输出设定正确，当实际接收到信号时才会听到声音(静噪电路开路)，您可以在1~3级范围内选择静噪带电平，默认值：2级。

静噪开启

按编程为“静噪开启”的按键时，对讲机会响“沙沙”的背景噪音，再按一次该键则关闭静噪。

暂态静噪开启

和静噪开启的功能相同，区别是需要一直按住才起作用，松开时则关闭静噪。

扫描

扫描功能可助您收听其他信道上的通信活动，从而了解相关组员当前的活动状况。按编程为扫描功能的按键后，启动扫描。“本机支持2种扫描方式：信道扫描方式和VFO扫描方式，VFO扫描方式仅在VFO信道下使用。”

信道扫描过程如下:

- 1、扫描时，对讲机LED闪橙灯。
- 2、扫描到某个信道上活动时，对讲机将停留在当前信道。
- 3、在扫描的过程中可以进行发射，发射模式由经销商配置。
- 4、如要停止扫描，按扫描键退出。

VFO扫描过程如下:

- 1、扫描时，对讲机LED闪橙灯，VFO信道频率按设定的频率步进进行变化。
- 2、扫描到某个频点上有活动时，对讲机将停留在当前频点，当活动消失时，将继续扫描。
- 3、在扫描过程中可以通过按[上箭头，注:使用具体图标]/[下箭头]键来选择扫描方向，向上为频率增加，向下为频率减小。
- 4、如要停止扫描，按扫描键或[PTT]键可退出扫描。

需要注意的是：扫描时VOX功能不起作用。

数字紧急报警系统

遇到紧急情况，您可通过此功能来向同伴或控制中心寻求帮助。通过紧急报警键可启动报警功能。

本机支持以下3种报警模式，您可通过经销商任选其一：

紧急警报：对讲机发出紧急警报，然后退出“紧急”模式。此警报是一种非语音信令，可触发另一部对讲机上的提示指示。若

当前信道被占用，将根据设定的礼貌与非礼貌发射的次数进行发射。

警报呼叫：将会发送紧急警报，然后通过按下一键通(PTT)按键发射紧急呼叫。若当前信道被占用，将根据设定的礼貌与非礼貌发射的次数进行发射。

紧急呼叫：将发送紧急警报并激活麦克风进行紧急呼叫。无需按下一键通(PTT)按键即可发射语音。

单独工作

如果在一段范围内对讲机一直无有效物理操作(按键)，在这段时间内会响起报警提示音，时间到达设定值后，则确认为紧急状况，进入紧急报警模式。

一键通

一键通功能可以让您方便的按照预定键设置的功能进行操作，该功能可以通过设置对讲机的侧键功能使用。

数字：对设定的联系人发送选呼、呼叫提示、对讲机检查、短消息、远程监听、数字遥毙或激活码。

加密

数字信道的独特功能，保证通话不会被第三方听到，呼叫双方需要密钥一致才能通话，从而使您的通信情况得以保密。

遥毙

当对讲机收到正确的遥毙码后，则对讲机将禁止发射/接收。对讲机将不能接收语音信号，只能接收激活码解除遥毙。

激活

当被遥毙的对讲机收到正确的激活码后，对讲机将解除遥毙功能。

远程监听

远程监听功能允许用户远程激活目标方对讲机的麦克风，使目标方对讲机秘密地发射背景语音给用户对讲机，从而达到被监听语音信息的效果。该功能主要在紧急情况下使用，只对数字信道有效。

对讲机检查

主叫用户可以采用对讲机检查功能，在不干扰某一无线对讲设备用户的情况下确认该设备是否开机工作。此功能只针对个呼。

对讲机键盘锁

当对讲机按下菜单键后2s内按下“*”键对讲机将把键盘进行锁定。

再次按下菜单键和“*”对讲机将对键盘解锁。

支持两种锁定模式:

仅键盘: 此模式下，仅对键盘进行锁定。信道旋钮及可编程按键及[PTT]键可以正常响应。

所有按键: 除[PTT]键外的所有按键（包括信道旋钮）均被锁定。

数字监听

可通过操作数字菜单“设置”-“数字监听”来开启该功能。当数字监听功能打开时，本机会根据数字监听规则监听当前信道下的数字通话，并在“信道信息”菜单中显示该DMR通话的信息（包括DMR ID和色码）。数字监听规则可配置为相同ID或任意ID、相同色码或任意色码。当配置为任意ID和任意色码时，可对当前信道上的所有数字通话进行监听。

信道强插

该功能能够远程中断一个正在发送可中断语音的对讲机呼叫过程。

语音强插: 本机在接收一个允许中断语音呼叫的过程中，可以随时中断对方的此次语音呼叫，本机按下[PTT]键，发出强插命令，等打断对方通话后，接着发起本机自己的通话。该功能只对数字信道有效，并在信道配置中将“接收过程发射权限”项配置为“发射中断”方可使用。

数模同解

当信道类型设置为混合信道时，可以同时数字呼叫或模拟呼叫进行解码接收。混合接收模式下，信道的模拟参数必须配置为带亚音接收模式。

您可通过对讲机的键盘输入用户别名、号码和短信等。本对讲机支持中文简体拼音输入法、英文输入法及数字输入法。

中文简体拼音输入法

操作方式:

- 1) 按[#]键切换至拼音输入法;
- 2) 按本机数字键依次输入拼音字母, 彩色屏幕会显示备选拼音及其对应的备选汉字;
- 3) 按[^]/[v]键选择所需拼音;
- 4) 按[菜单]键将高亮条移至中文汉字区, 再按[^]/[v]键选择所需汉字;
- 5) 按[菜单]键输入所选汉字。
- 6) 重复以上步骤完成输入。

注意: 只有对讲机通过编程软件设置语言类型为中文时, 才能切换为中文简体拼音输入法。

英文输入法

操作方式:

- 1) 按[#]键切换至大写或小写英文输入法;
- 2) 按本机数字键依次输入所需英文字母, 彩色屏幕会显示相应字母;
- 3) 重复以上步骤完成输入。

数字输入法

操作方式:

- 1) 按[#]键切换至数字输入法;
- 2) 按本机数字键依次输入相应的数字。
- 3) 要输入空格, 请按本机数字键[*]。

附表一、CTCSS模拟亚音频表(Hz)

1 - 67.0	11 - 94.8	21 - 131.8	31 - 171.3	41 - 203.5
2 - 69.3	12 - 97.4	22 - 136.5	32 - 173.8	42 - 206.5
3 - 71.9	13 - 100.0	23 - 141.3	33 - 177.3	43 - 210.7
4 - 74.4	14 - 103.5	24 - 146.2	34 - 179.9	44 - 218.1
5 - 77.0	15 - 107.2	25 - 151.4	35 - 183.5	45 - 225.7
6 - 79.7	16 - 110.9	26 - 156.7	36 - 186.2	46 - 229.1
7 - 82.5	17 - 114.8	27 - 159.8	37 - 189.9	47 - 233.6
8 - 85.4	18 - 118.8	28 - 162.2	38 - 192.8	48 - 241.8
9 - 88.5	19 - 123.0	29 - 165.5	39 - 196.6	49 - 250.3
10 - 91.5	20 - 127.3	30 - 167.9	40 - 199.5	50 - 254.1

附表二、DCS数字亚音代码表

023	071	143	225	266	356	452	532	664
025	072	145	226	271	364	454	546	703
026	073	152	243	274	365	455	565	712
031	074	155	244	306	371	462	606	723
032	114	156	245	311	411	464	612	731
036	115	162	246	315	412	465	624	732
043	116	165	251	325	413	466	627	734
047	122	172	252	331	423	503	631	743
051	125	174	255	332	431	506	632	754
053	131	205	261	343	432	516	645	
054	132	212	263	346	445	523	654	
065	134	223	265	351	446	526	662	

故障描述	故障原因分析	故障解决方法
无法开机	a. 电池可能未被正常安装	取出电池重新安装
	b. 电池电量可能已经耗尽	充电或更换电池
	c. 电池触点污浊或受损而导致接触不良	清洁电池触点。如仍不能解决问题，请联系经销商或指定维修点进行检修
接收信号时声音小、断续或无声	a. 电池电压过低	充电或更换电池
	b. 音量较小	调大音量
	c. 天线松动或安装不到位	关机后重新安装并旋紧天线
	d. 扬声器堵塞或受损	进行简单的外部清洁。如仍不能解决问题，请联系经销商或指定维修点进行检修
无法与组内成员通话	a. 所用频率或信令设置与组内其他成员不同	设置与组内其他成员相同的频率和信令
	b. 数字、模拟信道设置不当	设置相同的数字信道或模拟信道
	c. 距离组内其他成员太远	尽量靠近其他成员
信道中出现其他通话声或杂音	a. 受到同频用户的干扰	更改为新的频点，或调整静噪级别。
	b. 未设置信令	对组内所有对讲机进行信令设置，以防止同频干扰
噪声较大	a. 与其他成员之间的通讯距离过远	靠近其他成员
	b. 所处位置不佳，如受高大建筑物阻挡，或位于地下室等	移至开阔平坦地后，开机重试
	c. 受外界环境或电磁干扰	避开可能引起干扰的设备

清洁与保养

为了保证本产品发挥其良好性能，以及延长其使用寿命，请熟悉以下内容，以便更好地对本产品进行日常清洁与保养。

清洁

- ◆ 请定期使用洁净干燥的无绒布或毛刷拭去本产品表面及充电极片附着的粉尘；
- ◆ 本产品的按键、控制旋钮和机壳极易变脏。可用中性洗涤剂和无纺布对其进行清洁，请勿用去污剂、酒精、喷雾剂或石油制剂等化学药剂以避免其表面和外壳受损。清洁后，请务必保证本产品彻底干燥，否则请勿使用。



注意：

在进行清洁前，请关闭对讲机并将电池取出。

保养

- ◆ 请勿使用硬物穿刺或刮花本产品；
- ◆ 请勿将本产品存放于含有腐蚀电子电路物质的环境；
- ◆ 携带或使用本产品过程中，请勿用手提天线或耳机线；
- ◆ 当不使用附件时，请盖好附件接口盖。

产品保修卡

销售信息	经销商(盖章有效):
	联系电话:
	地址:
商品信息	产品型号:
	序列号:
	购买日期:
用户信息	用户姓名:
	联系电话:
	地址:

重要提示：

本保修卡作为最终用户享受保修服务的重要凭证，本保修卡须由授权经销商盖章并填写完整方才有效，请您妥善保管。

保修条款：

本产品保修期从销售日算起(以销售发票上的日期为准)。
主机保修12个月，电池及充电附件保修6个月。

在保修期内发生以下情况将实施有偿维修服务：

- (1) 不能出示本保修卡和购机发票；
- (2) 本卡有涂改痕迹或与产品不符；
- (3) 在非正常或非正常情况下使用本产品造成的缺陷或损坏；
- (4) 由于错误使用、意外、进水、疏忽造成的缺陷或损坏；
- (5) 由不正确的测试、操作、维修、安装、改装或调整等造成的缺陷或损坏；
- (6) 由未经授权的维修、拆卸等造成的缺陷或损坏；
- (7) 不可抗力因素造成的缺陷或损坏；
- (8) 正常使用情况下的磨损。

